



OPERATING MANUAL

---

## Ultrasonic gas flow rate meter RSM 200

Issued:	28th June 2024
Version:	02.2
Firmware:	1.2X

**Manufacturer** Contact our customer service department for technical information.

<b>Address</b>	RMG Messtechnik GmbH Otto-Hahn-Straße 5 D-35510 Butzbach (Germany)
<b>Main office</b>	+49 6033 897 – 0
<b>Service-Hotline</b>	+49 6033 897 – 897
<b>Fax</b>	+49 6033 897 – 130
<b>Email</b>	<a href="mailto:service@rmg.com">service@rmg.com</a>

**Translation of the original document** The **RSM200\_manual\_en\_02.2** manual dated 28th June 2024 for the RSM 200 ultrasonic gas flow rate meter with volume corrector is the original document. This document is a template for translations in other languages.

**Note** The latest version of this manual (and manuals other devices) can be downloaded at your convenience from our Internet page:

[www.rmq.com](http://www.rmq.com).

<b>Created</b>	24th November 2023
<b>1. Revision</b>	16th February 2024
<b>2. Revision</b>	13th May 2024

<b>Document version and language</b>	<b>Document version</b>	RSM200_manual_en_02.2 28th June 2024
	<b>Language</b>	EN

## TABLE OF CONTENTS

<b>1.</b>	<b>INTRODUCTION .....</b>	<b>1</b>	
<b>1.1.</b>	<b>STRUCTURE OF THE MANUAL .....</b>	<b>1</b>	
<b>1.2.</b>	<b>PURPOSE OF THE MANUAL.....</b>	<b>2</b>	_____
<b>1.2.1.</b>	<b>ABBREVIATIONS .....</b>	<b>2</b>	
<b>1.2.2.</b>	<b>SYMBOLS.....</b>	<b>4</b>	_____
<b>1.2.3.</b>	<b>STRUCTURE OF NOTICES .....</b>	<b>4</b>	_____
<b>1.2.4.</b>	<b>WORKING WITH THE DEVICE .....</b>	<b>5</b>	_____
<b>1.2.4.1.</b>	<b>SAFETY NOTICES DANGER, WARNING, CAUTION AND NOTE.....</b>	<b>5</b>	
<b>1.2.4.2.</b>	<b>DANGERS DURING COMMISSIONING .....</b>	<b>7</b>	
<b>1.2.4.3.</b>	<b>DANGERS DURING MAINTENANCE AND REPAIR.....</b>	<b>8</b>	
<b>1.2.4.4.</b>	<b>QUALIFICATION OF PERSONNEL .....</b>	<b>9</b>	
<b>1.2.5.</b>	<b>RISK ASSESSMENT AND MINIMIZATION .....</b>	<b>9</b>	
<b>1.2.6.</b>	<b>APPLICABILITY OF THE MANUAL.....</b>	<b>11</b>	
<b>1.2.6.1.</b>	<b>DANGER DURING OPERATION .....</b>	<b>12</b>	
<b>1.2.6.2.</b>	<b>DANGERS OF OPERATION IN EX AREAS.....</b>	<b>12</b>	
<b>1.2.6.3.</b>	<b>RESPONSIBILITY OF THE OPERATOR.....</b>	<b>12</b>	
<b>1.2.7.</b>	<b>TRANSPORT.....</b>	<b>13</b>	
<b>1.2.8.</b>	<b>SCOPE OF DELIVERY.....</b>	<b>13</b>	
<b>1.2.9.</b>	<b>DISPOSAL OF PACKAGING MATERIAL .....</b>	<b>14</b>	
<b>1.2.10.</b>	<b>STORAGE .....</b>	<b>14</b>	
<b>2.</b>	<b>OVERVIEW.....</b>	<b>15</b>	
<b>2.1.</b>	<b>DESCRIPTION .....</b>	<b>15</b>	
<b>2.2.</b>	<b>DEVICE FEATURES.....</b>	<b>15</b>	
<b>2.3.</b>	<b>POWER SUPPLY .....</b>	<b>17</b>	
<b>2.4.</b>	<b>AREA OF APPLICATION .....</b>	<b>18</b>	
<b>2.4.1.</b>	<b>INSTALLATION AND MOUNTING POSITION.....</b>	<b>18</b>	
<b>2.4.2.</b>	<b>TEMPERATURE RANGES.....</b>	<b>19</b>	
<b>2.4.3.</b>	<b>PRESSURE RANGE .....</b>	<b>20</b>	
<b>2.5.</b>	<b>USE OF THE RSM 200 FOR DIFFERENT GASES .....</b>	<b>20</b>	

---

2.5.1.	SUITABILITY AND COMPATIBILITY FOR H <sub>2</sub> -CONTAINING NATURAL GAS.....	21
3.	INSTALLATION .....	22
3.1.	ULTRASONIC FLOW RATE MEASUREMENT.....	22
3.2.	DESIGN AND MEASUREMENT PROCEDURE .....	23
3.3.	BASIC CURVE AND REYNOLDS NUMBER .....	26
3.3.1.	REYNOLDS CORRECTION FOR THE RSM 200 .....	27
3.4.	MEASURING RANGES AND PRECISION .....	29
3.5.	MOUNTING THE RSM 200 INTO THE PIPELINE .....	32
3.5.1.	SEALS.....	32
3.5.2.	SCREWS AND TORQUE.....	33
3.5.3.	INSTALLATION .....	35
3.5.4.	THRESHOLD VALUES .....	36
3.5.5.	TECHNICAL GUIDELINE G13.....	37
3.5.6.	PRESSURE LOSS .....	38
3.5.6.1.	COMMISSIONING THE DEVICE .....	38
3.5.7.	ROTATING THE DISPLAY.....	38
4.	INSTALLATION .....	40
4.1.	ELECTRICAL CONNECTIONS.....	40
4.1.1.	POWER SUPPLY .....	42
4.1.2.	DIGITAL COMMUNICATION .....	43
4.1.3.	DSFG F INSTANCE .....	43
4.1.4.	DIGITAL OUTPUTS.....	43
4.1.5.	ANALOG OUTPUT .....	45
4.1.6.	CONNECTING THE CABLES .....	45
4.1.7.	CABLES .....	46
4.1.8.	CABLE CONNECTION .....	46
4.1.9.	CONNECTION VIA SEPARATION BARRIER.....	47
4.1.10.	GROUNDING.....	50
5.	BASIC SETTINGS.....	52
5.1.	DISPLAY FIELD.....	52

---

5.1.1.	RESET .....	53
5.1.2.	BATTERY REPLACEMENT .....	55
6.	OPERATION .....	58
6.1.	MAINS MODE .....	59
6.2.	BATTERY MODE .....	60
6.3.	TEST MODE.....	62
6.4.	COUNTERS, ARCHIVES .....	65
6.4.1.	COUNTERS.....	65
6.4.2.	ARCHIVE .....	66
6.5.	OPERATION WITH THE PC SOFTWARE RMGVIEW <sup>RSM</sup> .....	68
6.6.	MENUS AND DISPLAY STRUCTURE .....	74
6.6.1.	SETTING WITH THE OPERATING KEYS .....	74
6.6.2.	MAIN/START DISPLAY .....	75
6.6.3.	STATUS DISPLAY .....	76
6.6.4.	ELECTRONIC TYPE PLATE.....	77
6.6.5.	EVENTS .....	78
6.6.6.	DISPLAY OF TEST MODE.....	78
6.6.7.	ARCHIVE .....	78
6.6.7.1.	EVENT ARCHIVE .....	80
6.6.7.2.	PARAMETER ARCHIVE.....	81
6.6.7.3.	PERIODICAL, DAILY AND MONTHLY ARCHIVE .....	82
6.6.8.	PARAMETERS .....	84
6.6.9.	ACCESS PROTECTION .....	86
6.7.	PROGRAMMING .....	87
6.7.1.	PROGRAMMING WITH THE PROGRAMMING BUTTONS.....	87
6.7.2.	EQUATIONS IN THE RSM 200 .....	89
6.7.3.	VARIABLE DESCRIPTION.....	90
6.7.4.	STANDARD FORMULAE.....	91
6.8.	COORDINATES IN CONTEXT .....	92
6.8.1.	VOLUME / COUNTERS.....	93

---

6.8.2.	FLOW RATE.....	93
6.8.3.	PRESSURE .....	95
6.8.4.	TEMPERATURE .....	95
6.8.5.	CONVERSION .....	96
6.8.6.	CURRENT OUTPUTS .....	100
6.8.7.	INFORMATION.....	101
6.8.8.	COMMUNICATION.....	103
6.8.9.	USM MEASURED VALUES .....	105
6.8.10.	MEASUREMENT PATH 1 DIAGNOSIS .....	106
6.8.11.	MEASUREMENT PATH 2 DIAGNOSIS .....	106
6.8.12.	USM PARAMETER.....	106
6.8.13.	ADJUST USM.....	107
6.8.14.	REYNOLDS CORRECTION .....	108
6.8.15.	SIGNAL SEARCH .....	110
6.8.16.	DIGITAL OUTPUTS.....	110
6.8.17.	RND PARAMETERS.....	114
6.8.18.	UNIT SYSTEM.....	114
6.8.19.	ARCHIVE .....	117
6.8.20.	SETTINGS .....	118
7.	TECHNICAL DATA.....	121
7.1.	GENERAL DATA OF THE RSM 200 .....	121
7.2.	OTHER INPUTS.....	122
7.2.1.	TEMPERATURE SENSOR .....	122
7.2.2.	PRESSURE TRANSDUCER.....	123
7.3.	OUTPUTS .....	123
7.3.1.	PULSE OUTPUTS .....	123
7.3.2.	DATA INTERFACE .....	124
7.4.	TECHNICAL DATA OF THE ISOLATING AMPLIFIER TYPE EX-400 .....	125
7.5.	OVERVIEW OF MATERIALS IN USE .....	127
7.6.	EX CERTIFICATIONS AND CONFORMITIES.....	128

---

8.	EVENT MESSAGES.....	129
8.1.	ERRORS (TOTAL OVERVIEW).....	131
8.1.1.	EFFECTS OF ERRORS, WARNINGS, AND NOTES .....	132
8.2.	WARNINGS.....	134
8.3.	NOTES .....	135
Δ	ANNEX.....	136
A	COUNTERS.....	136
A1	OVERVIEW.....	136
A2	SAVING THE COUNTER DATA .....	137
B	MODBUS .....	138
C	FLOW RATE CALIBRATION .....	154
D	STRUCTURE OF THE ARCHIVES.....	160
D1	ARCHIVE SIZE.....	160
D2	ARCHIVE TYPES.....	160
D2.1	PARAMETER ARCHIVES.....	160
D2.2	EVENT ARCHIVES .....	161
D2.3	MEASURED VALUE ARCHIVES .....	162
D3	ARCHIVE DISPLAY .....	163
D4	ARCHIVE HEADER .....	163
D5	READING OF ARCHIVE DATA VIA RMGVIEW <sup>RSM</sup> .....	166
D6	READING OF THE ARCHIVE DATA VIA MODBUS .....	167
E	ENCODER PROTOCOL.....	170
F	CALCULATION OF THE REYNOLDS NUMBER.....	172
G	DIMENSIONS .....	176
H	TYPE PLATE.....	179
I	SEAL PLANS .....	181
J	SPARE PARTS .....	183
K	FIRMWARE DOWNLOAD.....	188
L	CERTIFICATES AND APPROVALS.....	190





# 1. Introduction

## 1.1. Structure of the manual

This manual describes the handling of the RSM 200, which is available in 4 versions, as RSM 200 VM, RSM 200 VMF, RSM 200 VC and RSM 200 VCF. Where V = volumetric flow rate meter, M = (pure) volumetric flow rate meter at standard conditions, C = measurement and standard volumetric flow rate meter and F = fiscal, i.e., custody transfer use, i.e., without "F" = non-custody transfer use.

1

The manual consists mainly of two parts. The first part lists general specifications; the symbols used in the manual and the structure of notices are presented and a risk assessment is provided. Furthermore, it contains safety instructions and describes possible hazards during commissioning and maintenance. In addition, the first part includes specifications for the transport and storage of the RSM 200.

The second part, which begins with the second chapter, describes the special characteristics and areas of application of the RSM 200; basic standards are listed and the pressure and temperature ranges in which the RSM 200 can and may be used are presented. In addition, the installation and measurement conditions of the RSM 200 are presented.

The third chapter describes the basic function and mechanical commissioning of the RSM 200. An explanation of how to achieve the reliable commissioning of the meter and high precision is provided.

The fourth chapter describes the electrical installation and the connection options of the RSM 200. The fifth chapter describes the display; it explains a reset, booting and battery replacement.

The settings and the operation of the RSM 200 are discussed in chapter six. The use of the RMGView<sup>RSM</sup> software is also highlighted here, which greatly simplifies the setting and operation. This chapter also contains explanations of the adjustable parameters.

The seventh chapter summarizes the technical data. The eighth and last chapter contains a list of error messages.

The appendix at the end provides details on the counters, Modbus, flow rate calibration, archives, Reynolds number consideration, dimensions, nameplate, seal plans, and spare parts. Finally, the certificates and approvals are listed.

## 1.2. Purpose of the manual

This manual provides information that is necessary for fault-free and safe operation.

The RSM 200 was designed and produced according to the state of the art and generally recognized safety standards and directives. However, its use can entail dangers that are avoidable by complying with this manual. The device must only be used as intended and in technically sound condition.

### Warning

**In case of an incorrect use, all warranty claims may become invalid and the RSM 200 may also lose its approvals.**

### 1.2.1. Abbreviations

The following abbreviations are used:

RSM 200	The RSM 200 is an ultrasonic-based flow rate meter used for <b>custody transfer and non-custody transfer</b> volumetric flow rate measurement of the measurement volume of non-aggressive gases and fuel gases. With a pressure and temperature measurement, the integrated converter also allows the determination of the standard volume. RSM 200 = RMG <b>Sonic Meter 2</b> measuring paths.
MessEG	Measurement and Calibration Act Law on the marketing and provision of measuring devices in the market, their use and custody transfer use, valid since 1/1/2015
MessEV	Measurement and Calibration Regulation Regulation on the marketing and provision of measuring devices in the market and on their use and calibration; 12/11/2014
MID	Measurement Instruments Directive
PTB	Physikalisch-Technische Bundesanstalt [German National Test Authority]
Transducer	Ultrasonic sensor
approx.	approximately
if applicable	if applicable

generally	generally
max.	maximum
min.	minimum
LF	Low frequency; generally no signal is generated as frequency, but low-frequency pulses are output.
HF	High frequency; a high-frequency, rectangular voltage signal is output in accordance with the specifications in EN 60947-5-6.
MSB	Most Significant Bit (bit of highest value)
LSB	Least Significant Bit (bit of lowest value)
BAUD	Unit for the (electronic) transmission rate
BPS	Bits (Bytes) per second
INTEGER	Integer value
INT16	2 byte, 16 bit integer with algebraic sign.
INT32	4 byte, 32 bit integer with algebraic sign.
FLOAT	Floating point number
CHAR	Character, letter
UINT16	unsigned 16-bit data type
UIT32	unsigned 32-bit data type
NAMUR	Standards working group (interest group) for measurement and control technology
ATEX	ATEX is the abbreviation for the French term for potentially explosive atmospheres: "Atmosphères Explosibles". At the same time, ATEX is the abbreviation for the EU Directive 2014/34/EU.
IECEX	International Electrotechnical Commission System for Certification to Standards; International Ex Certification
RS485	General communication standard widely used in data acquisition and control applications.
CRC16	Cyclic Redundancy Check; method of checking information for errors during (data) transmission.

EEProm	Electrically Erasable Programmable Read Only Memory.
IR interface	Infrared interface
USZ	Ultrasonic meter; flow rate meter for gases based on ultrasonic transit time difference.
USM	Ultrasonic meter
FC	Flow corrector; a corrector that converts an measurement volume flow rate into a standard volume flow rate (with given pressure, temperature and gas data).
EVC	Electronic volume corrector: an electronic corrector (see FC)
CFD	Computational (numerical) Fluid Dynamics

### 1.2.2. Symbols

The following symbols are used:

1, 2, ...	Identifies steps for work tasks
..	

### 1.2.3. Structure of notices

The following notices are used:

<b>⚠ Danger</b>
<b>This warning notice informs you of imminently threatening dangers that can arise due to misuse/operator error. If these situations are not avoided, death or severe injuries can occur.</b>

<b>⚠ Warning</b>
<b>This warning notice informs you of potentially dangerous situations that can arise due to misuse/operator error. If these situations are not avoided, minor injuries can occur.</b>

<b>⚠ Caution</b>
<p>This notice informs you of potentially dangerous situations that can arise due to misuse/operator error. If these situations are not avoided, damage to the device or nearby property can occur.</p>

5

<b>Note</b>
<p>This notice informs you of potentially dangerous situations that can arise due to misuse/operator error. If these situations are not avoided, damage to the device or nearby property can occur.</p> <p>This notice can provide you with helpful tips to make your work easier. This notice also provides you with further information about the device or the work process in order to prevent operator error.</p>

## 1.2.4. Working with the device

### 1.2.4.1. Safety notices Danger, Warning, Caution and Note

<b>⚠ Danger</b>
<p><b>All of the following safety notices must be observed!</b></p>

Disregard of the safety notices can result in danger to the life and limb or environmental and property damage.

Bear in mind that the safety warnings in this manual and on the device cannot cover all potential dangerous situations, because the interaction of various conditions can be impossible to foresee. Merely following the instructions may not suffice for correct operation. Always remain attentive and consider potential consequences.

- Read this measurement manual and especially the following safety notices carefully before working with the device for the first time.
- Warnings are provided in the operating manual for unavoidable residual risks for users, third parties, equipment or other property. The safety instructions used in this manual do not refer to unavoidable residual risks.

- Only operate the device in fault-free condition and in observance of the operating manual.
- Compliance with local statutory accident prevention, installation and assembly regulations is also mandatory.

**⚠ Caution**

**All notices in the manual must be observed. Use of the RSM 200 is only permitted in accordance with the specifications in the operating manual. RMG assumes no liability for damages arising due to disregard of the operating manual.**

**The RSM 200 is approved for calibrated applications. For this purpose, it is sealed before delivery and settings specified by the approval authority are locked. These seals, software or hardware locks must not be damaged, destroyed or removed!**

**In this case, the RSM 200 loses its official certification!**

**The RSM 200 can only be approved for officially certified operation after a renewed inspection by an officially recognized inspection authority or custody transfer officials and an additional inspection of additional settings. The custody transfer official must re-apply the seals after the inspection.**

**⚠ Danger**

**Service and maintenance tasks or repairs that are not described in the operating manual must not be carried out without prior consultation with the manufacturer. The device must not be opened forcefully.**

Observe the following, in particular:

- Changes to the RSM 200 are not permitted.
- The technical specifications must be observed and followed for safe operation. Performance limits must not be exceeded (*chapter 7 Technical data*).
- For safe operation, the RSM 200 must only be used in the scope of the intended use (*chapter 2 Overview*).
- The RSM 200 complies with current standards and regulations. However, danger can arise with misuse.

**1.2.4.2. Dangers during commissioning**

Initial commissioning	The initial commissioning must only be carried out by specially trained personnel (training by RMG) or RMG service personnel.
Mechanical installation	Mechanical installation must only be performed by appropriately qualified technicians.
Electrical installation	Installation on electrical components must only be carried out by qualified electricians.
Mechanical and/or electrical installation	These qualified personnel require training specifically for work in explosion-prone areas. Qualified personnel are persons who have training / education in accordance with <b>DIN VDE 0105, IEC 364</b> or <b>comparable standards</b> .

7

**Note**

**An acceptance test certificate must be created during the commissioning. This, the operating manual and the EU Declaration of Conformity must be stored so that they are always readily available.**

**As far as possible, all sharp edges on the device have been eliminated. However, personal protective equipment provided by the operator must be worn during all work.**

### **⚠ Danger**

Install the device as specified in the operating manual. If the device is not installed as specified in the operating manual, there may be a risk that adequate explosion proof is not provided.

#### **The explosion proof is lost!**

Inadequately qualified persons working on the equipment are unable to correctly estimate dangers. If work on live equipment must be conducted in explosion-prone areas, sparks that are created can trigger an explosion. Only work on the equipment if you have the appropriate qualifications.

Components can be damaged if you do not use suitable tools and materials. Use tools that are recommended for the respective work in the operating manual.

Installation and removal of the RSM 200 must only take place in an explosion-free, pressure-free atmosphere. The descriptions in the operating manual must be observed. In general, it is recommended that the replacement should only be carried out by the RMG service department.

A leak test must be carried out after work on pressurized components.

All of the above points also apply to repair and maintenance tasks and in general when opening the meter is necessary.

Flange fasteners, screw plugs, screw fittings, pressure tapping fittings, valves and rotary adapters must not be loosened during operation.

The RSM 200 must only be used as intended! (*chapter 2 Overview*). Prevent use of the RSM 200 as a potential climbing aid or use of attachments of the RSM 200 as potential handles!

#### **1.2.4.3. Dangers during maintenance and repair**

Operating personnel	The operating personnel use and operate the device in the scope of the intended use.
Maintenance personnel	Work on the device must only be carried out by qualified personnel who can carry out the respective tasks on the basis of their technical training, experience and familiarity with the applicable standards and requirements. These qualified personnel are familiar with the applicable statutory regulations for accident prevention and can independently recognize and avoid potential dangers.



Maintenance and cleaning

Maintenance and cleaning must only be performed by appropriately qualified technicians.

<b>⚠ Danger</b>
<p>The device can be damaged if it is not cleaned as specified in this operating manual. Only clean the device as specified here:</p> <ul style="list-style-type: none"> <li>- Only clean the device with a damp cloth!</li> <li>- Electrostatic charges (especially of the housing) must be avoided!</li> </ul>

9

---



---



---



---

#### 1.2.4.4. Qualification of personnel

<b>Note</b>
<p>In general, the following is recommended for all persons working with or on the RSM 200:</p> <ul style="list-style-type: none"> <li>• Training / education for work in explosion-prone areas.</li> <li>• The capacity to be able to correctly estimate dangers and risks when working with the RSM 200 and all connected devices. Possible dangers include components that are under pressure and consequences of incorrect installation.</li> <li>• Recognition of dangers that can arise from the flow medium that is used.</li> <li>• Training / education by RMG for work with gas measuring devices.</li> <li>• Education / instruction in all national standards and directives to be complied with for the work to be carried out on the device.</li> </ul>

#### 1.2.5. Risk assessment and minimization

According to assessment by qualified employees of RMG, the RSM 200 is subject to risks during its use. Risks can occur for example due to high pressures and occasionally due to pressures that are too low. Work outside of the permissible temperature range can also lead to dangers. Impermissible current and voltage values can trigger explosions in explosion-prone areas. The risk assessment assumes that the pipeline is drained and ventilated when the meter is installed or removed. Then and only then is it assured that there is not an explosion-prone gas mixture in the pipeline.

Naturally, work must only be carried out by trained personnel (see *chapter 1.2.4.4 Qualification of personnel*), who are also trained to recognize suitable tools and use them exclusively. The risks were summarized alongside development and measures were taken to minimize these risks.

#### Measures for risk minimization:

- All pressure bearing parts are designed in accordance with AD 2000 code, PED Annex 1 and are compliant with ASME B31.3-2018 and ASME B31.8-2018.
- The complete pressure design has been inspected by TÜV Hessen.
- All pressurized parts have been manufactured with a material certificate; there is an uninterrupted change of batch tracing of pressurized components.
- The mechanical properties of all relevant pressurized components have been subjected to tension tests, notch impact bending tests and hardness tests.
- Non-destructive testing was also carried out: X-ray and ultrasonic inspection of the meter housing for defective points in material, surface crack testing with magnetic powder and a color penetration process.
- Strength tests for components were conducted at 1.5 times the nominal pressure for the pressure testing; the leak testing for the assembly was conducted at 1.1 times the nominal pressure. Certificates were issued for successfully passed tests.
- The maximum operating pressure and the permissible temperature range are specified on the type plate of the device. Operation of the device is only permitted within these specified ranges.
- A maximum temperature difference of  $\Delta T \leq 100^\circ\text{K}$  between the indoor and outdoor areas of the RSM 200 must be maintained.
- Additional external forces and moments were not considered in the pressure designs.
- In the event that the pressure equipment is to be marketed and put into operation as an assembly within the meaning of the Pressure Equipment Directive, an assessment of the assembly must be provided at the latest as part of the final and pressure test.  
Otherwise, the acceptance inspector must explicitly point out that a test of the equipment location with safety function must still be performed at the installation site.

**⚠ Danger**

The following applies for work in explosion-prone areas:

- Every Ex signal circuit must be routed with a dedicated cable which must be guided through the appropriate PG screw coupling.
- Permanent installation of the intrinsically safe cable is mandatory
- If one or more power circuits are used, it must be ensured that the permissible limit values according to the EC type approval certificate are not exceeded when choosing the cables.
- The outputs of the meter are to be connected exclusively to intrinsically safe circuits.
- Only tools that are approved for Ex Zone 1 are permitted for maintenance and repair tasks. Otherwise, work must only be carried out when there is not an explosive atmosphere.
- The risk of ignition due to impact or friction must be avoided.

In addition, the following applies for work in explosion-prone areas (all zones):

- Work on devices which are used in explosion-prone areas must be carried out by qualified electrical engineers with special capabilities for work in explosion-prone areas. This is to be checked by responsible specialists.
- Qualified persons have been authorized by the person responsible for safety of personnel to carrying out such work on the basis of their training, experience or instruction and familiarity with applicable standards, provisions, accident prevention regulations and system conditions. It is essential that these persons are able to recognize and avoid potential dangers in good time.
- Attention: Risk of destruction due to body electricity, e.g. due to the rubbing of clothing.
- Qualified persons must satisfy the definitions in accordance with DIN EN 0105 or directly comparable standards.

### 1.2.6. Applicability of the manual

This manual describes the RSM 200. RSM 200 is generally only part of a complete system. The manuals of the other components of the system must be observed. If you find contradictory instructions, contact RMG and/or the manufacturers of the other components.

**Note**

Ensure that the power data of the current connection matches the specifications on the type plate. Ensure that the limit values specified in the conformity certificate (see appendix) for the devices to be connected are not exceeded.

Observe any applicable national regulations in the country of use. Use cable that is appropriate for the cable fittings.

**1.2.6.1. Danger during operation**

Observe the specifications of the system manufacturer and/or system operator.

**1.2.6.2. Dangers of operation in EX areas**

Only operate the device in fault-free and complete condition.

If you make technical changes to the device, safe operation can no longer be guaranteed.

**⚠ Danger**

Only use the device in its original condition. The RSM 200 is permitted for operation in Ex Protection Zone 1, but only within the permissible temperature range (*chapter 2.4.2 Temperature ranges*).

**1.2.6.3. Responsibility of the operator**

As the operator, you must ensure that only adequately qualified personnel work on the device. Ensure that all employees who work with the device have read and understood the manual. You are also obligated to train personnel regularly and inform them of the dangers. Ensure that all work on the device is carried out exclusively by qualified persons and inspected by responsible qualified supervisors. The responsibilities for installation, operation, fault rectification, maintenance and cleaning must be clearly regulated. Instruct your personnel with regard to the risks involved with working with the device.

### 1.2.7. Transport

The device is packaged specific to the transport requirements for each customer. Ensure safe packaging that absorbs light impact and vibrations is used for any further transport. Nevertheless, inform the transport company that all types of impact and vibrations should be avoided during transport.

**Warning**

**Risk of injury during transport**

**Any foot screws must be mounted if they are provided as a transport safeguard to prevent rolling and tipping. Additional measures must be taken to ensure that impermissible rolling and tipping are prevented.**

**Only use the provided lifting eyes / ring screws to lift the meters. The measuring device must always be moved by means of a crossbeam. Lifting exclusively with a simple chain attached to the lifting lugs is not permitted.**

**Please observe the relevant permissible loads for the lifting equipment. Prior to lifting, ensure that the load is securely fastened. Do not stand under suspended loads.**

**The device can slip, topple over or fall down when being lifted and set down. The device can fall over if the bearing capacity of the lifting equipment is disregarded. There is a risk of severe injury for nearby persons.**

**The measuring device and accessories must be protected from impacts and vibrations during transport.**

**The meter has a flange as a termination at each end. The flanges are sealed with a protective sticker or fitted with a plastic dummy plug. The protective stickers and/or dummy plugs must be removed without leaving any residue prior to installation in the pipeline. Residue from this film changes the flow and causes measuring errors!**

**This protection must be re-applied to the flanges for transport or storage of the device.**

### 1.2.8. Scope of delivery

The scope of delivery can differ depending on the optional orders. The following is "normally" included in the scope of delivery:

Part	Quantity
RSM 200	1
Manual	1

Test log	1
Calibration certificate	Optional
Material test certificate	1
Strength test certificate 3.1.	Optional

### 1.2.9. Disposal of packaging material

Dispose of the material in an environmentally friendly manner in accordance with national standards and directives.

### 1.2.10. Storage

Avoid extended periods of storage. After storage, inspect the device for damage and test for correct function. Contact the RMG service department to arrange for inspection of the device after a storage period of longer than one year. For this purpose, return the device to RMG.

#### Note

**Storage must take place in a dry and protected room.**

**It must be ensured that all open pipes are sealed.**

## 2. Overview

### 2.1. Description

The **RSM 200** is a gas volume flow rate meter used to measure the volume flow rate of the volume of natural gas. The operating volume flow rate is determined by means of the ultrasonic transit time difference measuring method. The accumulated volume is integrated over time and the result is recorded with an electronic controller. This measurement volume flow rate is determined at the respective pressure and temperature conditions, which can be additionally recorded. The integrated corrector of the RSM 200 allows the calculation of the standard volume flow rate (i.e. e.g. at 0°C and 1013 mbar) from the measurement volume flow rate using the pressure and temperature data. Special gas properties can be taken into account in using different gas models for correct gas status determination. The measured measurement volume and / or the calculated standard volume are added up in internal archives.

As output there are different frequency outputs, e.g. a frequency output (HF), which allows the use as flow rate transmitter for control tasks. In addition, the RSM 200 has serial RS 485 interfaces for digital data readout and parameterization. The RSM 200 is used in **custody transfer** and **non-custody transfer** applications.

The RSM 200 has 4 variants, the RSM 200 VM and RSM 200 VMF, which can be used for pure (operating) volume flow rate measurements in non-custody transfer applications (...VM) and in custody transfer applications (...VMF) and the RSM 200 VC (non-custody transfer application) and RSM 200 VCF (custody transfer application), which are used for the determination of measurement and standard volume with a volume correction at existing pressure and temperature value.

### 2.2. Device features

- Non-custody and custody transfer measurements
- Approval according to European Measuring Instruments Directive MID
- Design according to DIN ISO 17089
- No moving parts
- Integrated, custody transfer approved volume corrector according to EN12405 for volume correctors
- Pressure and temperature measurement (display, output and archiving).

- Computation of the K parameter acc. to GERG88S, GERGS-mod-H2, AGA8 GROSS M1/M2, AGA NX19 and GOST30319-2.
- Display: among others can be displayed:  
Measurement volume, standard volume, instantaneous and maximum flow rate,  
...
- Terminal compartment  
Pressure and temperature can be sealed separately from the rest of the electronics.
- Battery or mains operation (power failure proof) for > custody transfer period, i.e. > 5 years
- Explosion proof  
The RSM 200 is intrinsically safe and can be used in Zone 1 and 2.
- 4 digital outputs: all DO are galvanically isolated from each other:  
1 x DO (inverted HF signal to DO2) or serial data output (encoder protocol; activation by Namur loop).  
1 x DO: HF signal (operating volume flow) or pulse for corrector or data recorder, status, alarm or warning  
1 x DO: Pulses for correctors or data recorders, status, alarm or warning.  
1 x DO: Pulses for data recorders
- 1 analog output 4...20 mA (in preparation)
- 1 digital interfaces serial RS 485, interface for Modbus connection, galvanically isolated, to be externally supplied
- Optical infrared interface RS 485 (activated via a reed contact)
- Archive  
Integrated fail-safe parameter, event and measured value archive.
- RMGView<sup>RSM</sup>  
Included software for convenient parameterization and management of the device and the stored data as well as for remote diagnostics.

### **RSM 200 VMF + Volume Corrector EVC Primus 400**

The use of the MID-approved volume corrector EVC Primus 400 allows additional uses; especially together with the RSM 200 VMF. This combination allows the measurement, storage and display of the maximum load. Also possible is the communication and remote reading; there is a GSM/GPRS/LTE modem with the possibility of connecting an additional modem (multi-client capability). Further features of this devices can be found in the documentation on the RMG homepage [www.rmg.com](http://www.rmg.com).



## 2.3. Power supply

The RSM 200 can be operated both mains-powered and in battery mode. In battery operation, the device is energy self-sufficient; a long service life is to be achieved; the RSM 200 operates in an energy-saving manner here; some data outputs are not possible in battery operation see *chapter 6.2 Battery mode*.

17

### Battery-operated device

The RSM 200 is equipped with 6 replaceable 3.6 V lithium batteries (note battery type: see *chapter 5.1.2 Battery replacement*) The device is designed to allow continuous operation for at least 5 years, i.e. at least the length of a calibration period.

### Battery replacement indicator

Internally, a calculation of the remaining battery life takes place. An indicator in the display appears when it is time to replace the battery. Battery replacement is described in *chapter 5.1.2 Battery replacement*. In parameter G23 *Date of last battery change* the date of the last battery change is displayed (see *chapter 6.8 Coordinates in context*).

### Mains mode

In the event of a failure of the external power supply, the RSM 200 continues to be supplied via the BACK battery compartment, i.e. 3 of the 6 lithium batteries, provided this battery compartment is fitted. In general, a total bridging time of more than 3 months is achieved with 3 additional batteries for normally mains supplied devices as backup. Measurements and data output are not interrupted in the process. The battery symbol is displayed in this case. For reasons of fail-safety of the RSM 200, this battery equipment is strongly recommended.

## 2.4. Area of application

The RSM 200 is approved for use in hazardous areas in Zone 1 and 2, the markings are:



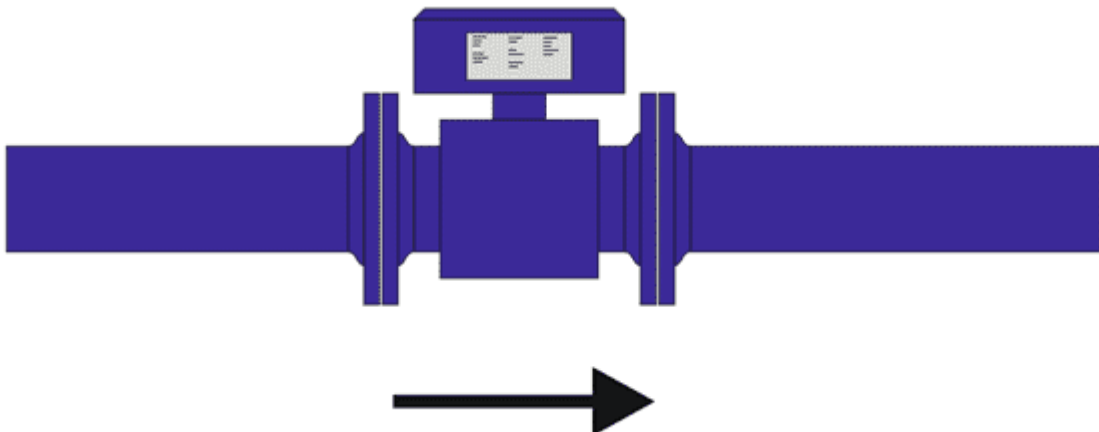
II 2G Ex ia IIC T4 Gb

The EC type approval certificate is:

**BVS 23 ATEX E 019 X**

The corresponding conformity certificates are provided in the annex. The RMG contact information is provided on the second and last pages.

### 2.4.1. Installation and mounting position



**Figure 1: Mounting position**

The RSM 200 can be supplied with flange connections according to DIN and ANSI. The installation position is free for dry, clean gases; to reduce the influence of condensate build-up (should not occur in dry gas), a horizontal installation position is preferred (see *Figure 1: Mounting position*).

**Note**

During installation, make sure that the display and type plate can be read. Prevent reading from being obstructed by light (e.g. strong lamp, sun) or shade (e.g. installation in front of a wall).

### 2.4.2. Temperature ranges

The following temperature ranges are permitted for the RSM 200:

Temperature ranges	
Media temperature	-40°C to +80°C
Approved temperature range for gas models: GERG 88 S, GERG S-mod-H2, AGA8-GROSS method 1, AGA8-GROSS method 2 AGA8-NX19, GOST30319-2	-20°C to +65°C at p < 25 bar -25°C to +65°C at p < 15 bar -10°C to +55°C -10°C to +55°C -10°C to +30°C 250°Kelvin to 350°Kelvin
Environmental temperature	-40°C to +80°C (only applicable in not hazardous areas)
Acc. to ATEX (T <sub>amb</sub> )	-40°C to +60°C (with batteries) -40°C to +70°C (without batteries)
Designed according to PED 2014/68/EU	-40°C to +60°C (Aluminum housing) -25°C to +60°C (Nodular graphite casting) -40°C to +80°C (Cast steel) -40°C to +80°C (Fine-grain steel)

**Table 1**

**Note**

If different temperature ranges apply simultaneously, the smallest specified range applies for the overall system. This is also marked on the type plate.

Ambient humidity may be up to 95% relative humidity but should not be condensing.

The protection class is IP 66.

### **⚠ Caution**

Direct solar radiation must be avoided.

20

### 2.4.3. Pressure range

Flange connection	Designed pressure range
PN10 (DIN EN 1092-1)	10
PN16 (DIN EN 1092-1)	16
ANSI150RF (ASME B 16.5)	20

*Table 2*

## 2.5. Use of the RSM 200 for different gases

The device may only be operated with the following gas types; safe operation is guaranteed with these specified gas types:

- Class 1 gases
- Class 2 gases
- Class 3 gases

The components of the gases must be within the concentration limits according to EN 437:2009 for test gases.

Essentially, these are air and natural gases.

### **Note**

The gas to be measured must not form any condensates in the measurement range of the RSM 200 and must be free of corrosive and aggressive components, liquids and solids.

In case of different conditions, a suitable operation must be agreed with RMG's service department (contact details: see second or last page).

### 2.5.1. Suitability and compatibility for H<sub>2</sub>-containing natural gas

The RSM 200 can be used in natural gas containing hydrogen. There are no safety concerns in this regard.

#### Note

**The use of the RSM 200 in natural gases with a maximum hydrogen content of 10 mol-% is possible in general with the accuracies specified in chapter 3.4 *Measuring ranges and precision*. The application corresponds to the TR-G19 valid in Germany.**

21

Since there are currently no officially approved test facilities in Germany to calibrate meters with gases containing more hydrogen, accuracy above the 10 mol-% cannot be verified or guaranteed. Please ask RMG whether a reduced measuring range must be expected above 10 mol-%.

#### Note

**Use at a higher H<sub>2</sub> content is under ongoing investigation. Consult RMG - if necessary - to see if it is possible to use it in this case.**

## 3. Installation

In the following, operating instructions of the RSM 200 are presented, which serve to ensure safe and reliable operation.

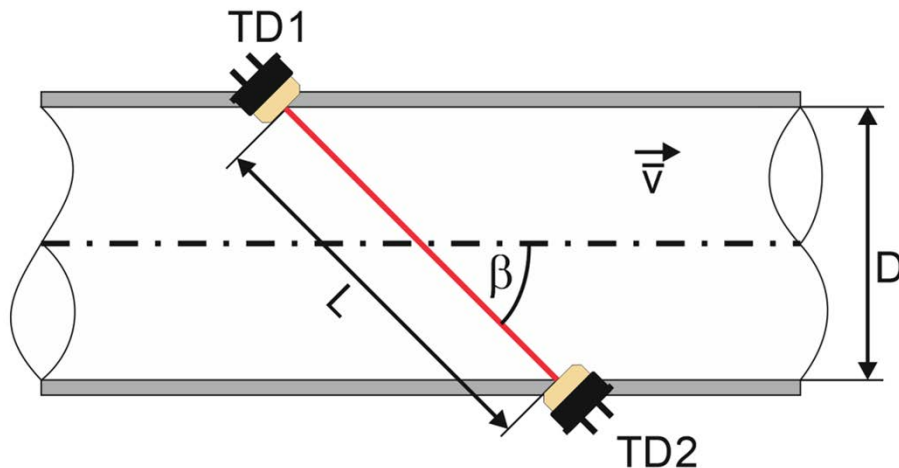
22

### Note

Chapter 3 presents settings that should only be made after you have read the descriptions in the *chapter 6 Operation*.

### 3.1. Ultrasonic flow rate measurement

The operation of a flow rate meter is based on the determination of the transit time difference of an ultrasonic pulse with and against the flow. *Figure 2: Two sensors form a path for the measurement* shows the basic principle. The transducers TD1 and TD2 are opposite each other for the measurement and form a measurement path with the distance  $L$ . An ultrasonic pulse covers the measurement path from sensor TD1 to transducer TD2 faster with the flow than vice versa against the flow. Physically, this is caused by the drag effect due to the flow of the gas; the arrow above  $\vec{v}$  indicates the direction of flow.



**Figure 2: Two sensors form a path for the measurement**

The transit times from TD1 to TD2 ( $:= t_{TD12}$ ) and from TD2 to TD1 ( $:= t_{TD21}$ ) are calculated according to the following formulas:

$$t_{TD12} = \frac{L}{c_0 + \vec{v} \cdot \cos\beta} \quad \text{and} \quad t_{TD21} = \frac{L}{c_0 - \vec{v} \cdot \cos\beta}$$

These transit times of the ultrasonic pulse are determined with the ultrasonic electronics. From these, the average speed  $\bar{v}$  along the measurement path can be determined:

$$\begin{aligned} \bar{v} &= \frac{L}{2 \cdot \cos\beta} \cdot \left( \frac{1}{t_{TD12}} - \frac{1}{t_{TD21}} \right) \\ &= \frac{L^2}{2 \cdot d} \cdot \frac{t_{TD21} - t_{TD12}}{t_{TD12} \cdot t_{TD21}} \\ &= \frac{L^2}{2 \cdot d} \cdot \frac{\nabla t}{t_{TD12} \cdot t_{TD21}} \end{aligned}$$

Where:

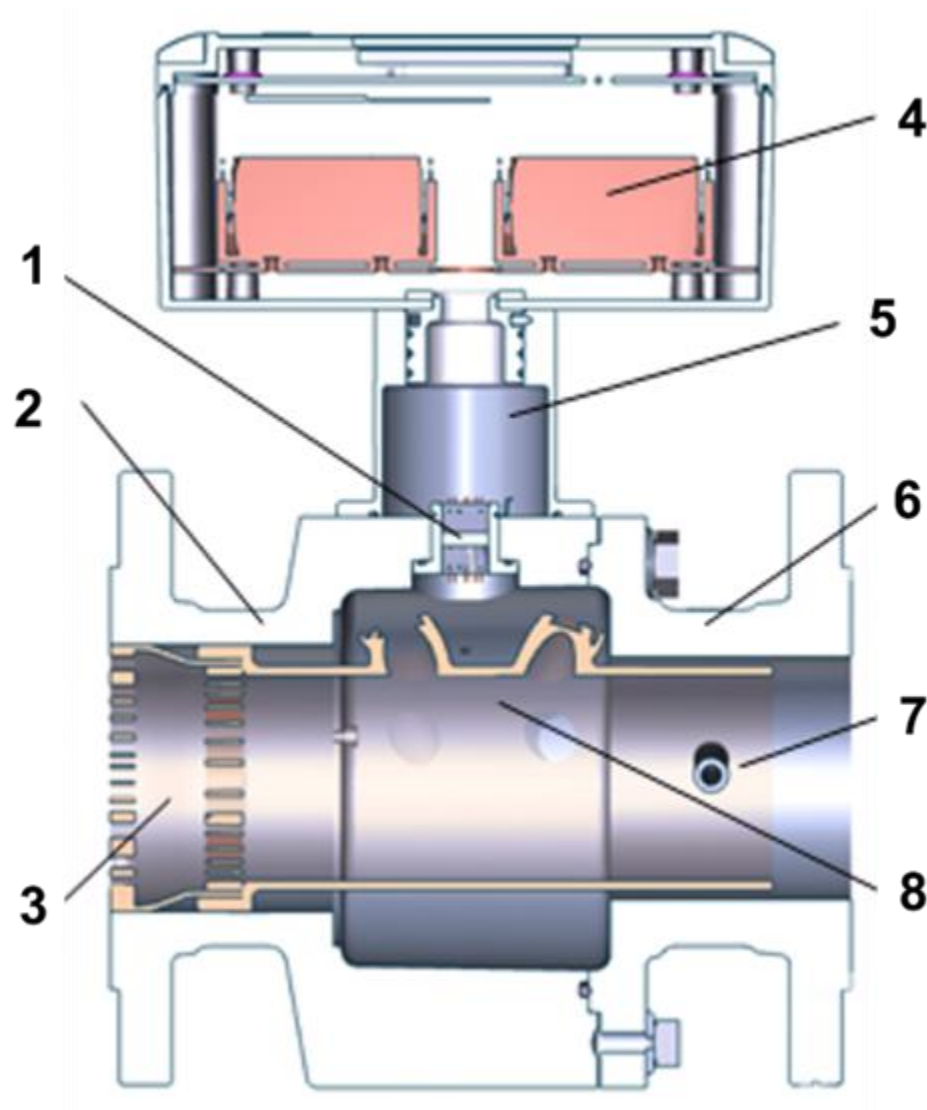
- $\bar{v}$  - average flow speed
- $c_0$  - Speed of sound
- $\beta$  - Path angle relative to the pipe axis
- $L$  - Path length
- $d$  - Diameter (for path angles which intersect with the pipe axis  
For other measurement paths an analog value results).
- $\nabla t$  -  $t_{TD21} - t_{TD12}$

It is important to note that only the transit times and device parameters such as the distance of the transducers and angle of the measurement path to the flow direction are required for this calculation. All parameters that involve gas dependency are omitted.

## 3.2. Design and measurement procedure

The RSM 200 is designed for unidirectional flow rate measurement of dry gases. An arrow on the device indicates the flow direction (also see *chapter 3.5.7 Rotating the display, Figure 8: Rotating the display*). To be compatible with the installation dimension of a standard turbine wheel gas meter, the installation length of the RSM 200 is 3 x DN, i.e. for an RSM 200 in DN80, for example, the installation length is 240 mm.

The internal structure of the RSM 200 consists of 3 sections, an inlet for flow conditioning, a measuring cell and an outlet. The overall structure can be seen in *Figure 3: Design of RSM 200*.



**Figure 3: Design of RSM 200**

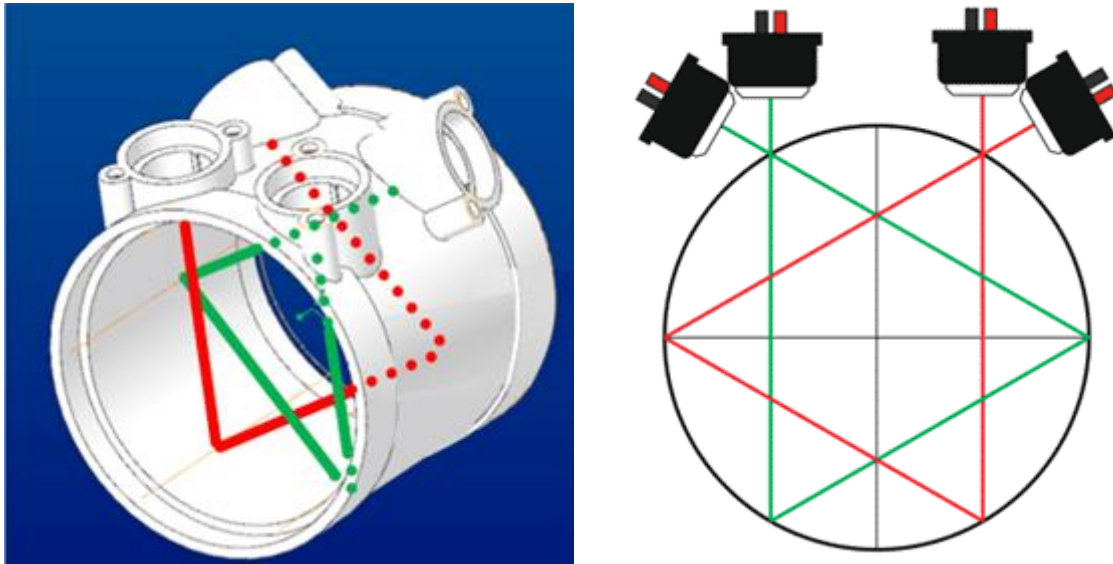
- |   |  |   |  |
|---|--|---|--|
| 1 | Glass feedthrough                      | 5 | Rotatable housing neck                       |
| 2 | Inlet section                          | 6 | Outlet section                               |
| 3 | Flow conditioning                      | 7 | Immersion sleeve for temperature measurement |
| 4 | Electronics compartment with batteries | 8 | Measurement cell with ultrasonic sensors     |

The inlet with the integrated converters was optimized with CFD support in order to achieve the desired accuracies together with the ultrasonic measuring paths in the measuring cell (see *chapter 3.4 Measuring ranges and precision*).

The measuring cell is installed inside the RSM 200. In order to determine the average velocity over the pipe cross-section, the measurement path is implemented as a two-fold reflecting Gaussian integration. A second measuring path covers further cross-



sectional areas and detects a swirl flow with reversed influence on the measuring signal. In sum, this compensates for the influence of a swirl flow. The *Figure 4: Double reflection of the ultrasonic beams* shows the basic setup of the sensors in the measuring tube to generate these measurement paths.



25

---



---



---



---

**Figure 4: Double reflection of the ultrasonic beams**

The ultrasonic measurement paths have an angle  $\beta$  of  $76^\circ$  to the tube axis.

The measuring path arrangement determines the average velocity in the tube. The volume flow rate  $Q_m$  results from the average value of the two velocities along the respective measuring paths multiplied by the pipe cross-section  $A$ :

$$Q_m = \frac{\bar{v}_1 + \bar{v}_2}{2} \cdot A$$

The index  $m$  at  $Q_m$  indicates that the volume flow rate is determined at measurement conditions, i.e. the present pressure and temperature conditions. In addition to the mean flow speed, the speed of sound  $c_0$  in the sample gas can also be determined from the transit time data.

$$c_0 = \frac{L}{2} \cdot \frac{t_{TD12} + t_{TD21}}{t_{TD12} \cdot t_{TD21}}$$

The speed of sound is permanently determined as a further measured variable and can also be output.

**Note**

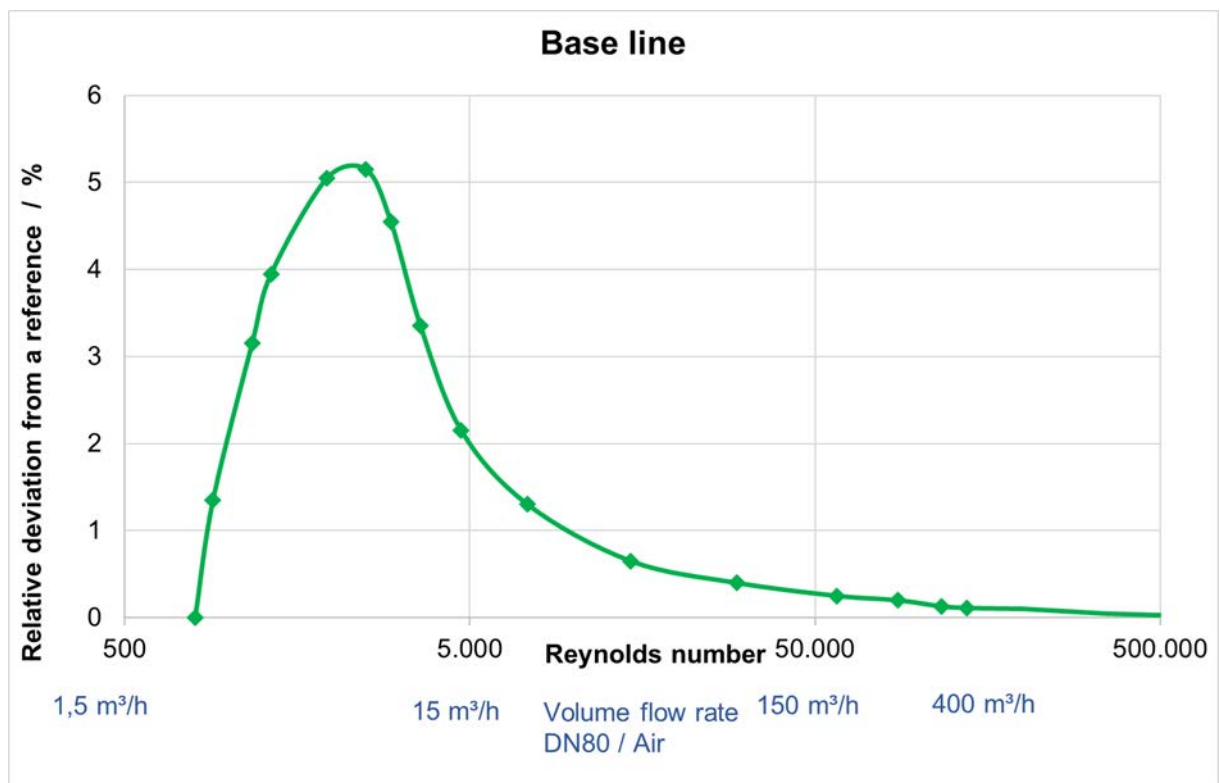
The speed of sound (SoS) mainly depends on the gas composition and the temperature.

Therefore, for the same temperature and for a change in the speed of sound, it can generally be assumed that the gas composition has changed.

26

### 3.3. Basic curve and Reynolds number

The multiplication of the speed averaged over the measuring paths with the pipe cross-section (see above) does not reflect the actual flow rate in the entire flow rate range. Especially at the lowest flow rates there are significant deviations, in the upper flow rate range the characteristic curve becomes flat, possibly, with a slight gradient.



**Figure 5: Typical basic characteristic curve**

In terms of flow technology, the reference here is not the flow rate value, but the Reynolds number, which here represents a kind of dimensionless flow rate value. This correction is stored with the "basic characteristic curve"; i.e., depending on the

Reynolds number, a (percentage) deviation from the simple flow rate calculation (average velocity x pipe cross-section) is corrected. This is shown in the previous figure.

For this Reynolds correction, it is necessary to determine the Reynolds number at the current flow rate. The Reynolds number results from:

$$Re = \frac{u \cdot d \cdot p}{(T + 273,15)} \cdot 100.000 \cdot Mf$$

Where

- p* – pressure in the pipe; [*p*] = bar (a)
- u* – average speed in the pipe; [*u*] = m/s
- d* – diameter of the pipe; [*d*] = m
- T* – temperature within the pipe; [*T*] = °C
- Mf* – medium factor

Below an adjustable Reynolds number (*Re<sub>min</sub>*) no correction by the determination polynomial takes place, the correction at *Re<sub>min</sub>* is frozen and below *Re<sub>min</sub>* applied to the uncorrected measured value.

You can find more details in *Annex F Calculation of the Reynolds number*.

### 3.3.1. Reynolds correction for the RSM 200

In principle, one needs the temperature and the pressure present to calculate the Reynolds number. These parameters are available in the RSM 200 VC and RSM 200 VCF versions and are determined by the corresponding sensors.

In the RSM 200 VM and RSM 200 VMF versions, these variables cannot be determined by pressure and temperature sensors. However, the flow rate meters are often operated at (approximately) constant pressure conditions. To take the pressure into account, it is then sufficient to enter this measurement pressure as a fixed value at the coordinates **C03 pressure default**. In contrast to the RSM 200 VCF, the pressure default parameter is then non-custody transfer.

**Note**

**Taking the pressure into account via the fixed value pressure default only makes sense as long as the actual pressure does not deviate from it to a greater extent.**

**0,8 x default pressure      up to      1,2 x default pressure**

**Therefore, conscientiously check your conditions when setting the default value.**

The temperature T can be determined via the speed of sound measured by ultrasound:

$$T[^\circ\text{C}] = b_2 \cdot \left( c_{\text{Gas}} \left[ \frac{\text{m}}{\text{s}} \right] \right)^2 + b_1 \cdot c_{\text{Gas}} \left[ \frac{\text{m}}{\text{s}} \right] + b_0$$

28

An automatic mode (see *chapter 6.8.14 Reynolds correction*) detects whether air or natural gas is present. The natural gas deposited here is a natural gas H containing 98.302% methane; 1.36% nitrogen; 0.338% carbon dioxide and a dynamic viscosity of  $10,2 \times 10^{-6} \text{ Pa} \cdot \text{s}$  (at standard conditions). In general, i.e., for all natural gas-like gases, the temperature determined in this way is more accurate than a simple fixed value.

If the gas does not correspond to a natural gas H with the specified values, then the accuracy of the Reynolds number determination and the temperature calculation can be increased if the individual gas parameters are known (composition of the gas and dynamic viscosity). RMG's service department will then help you with the necessary calculations and settings.

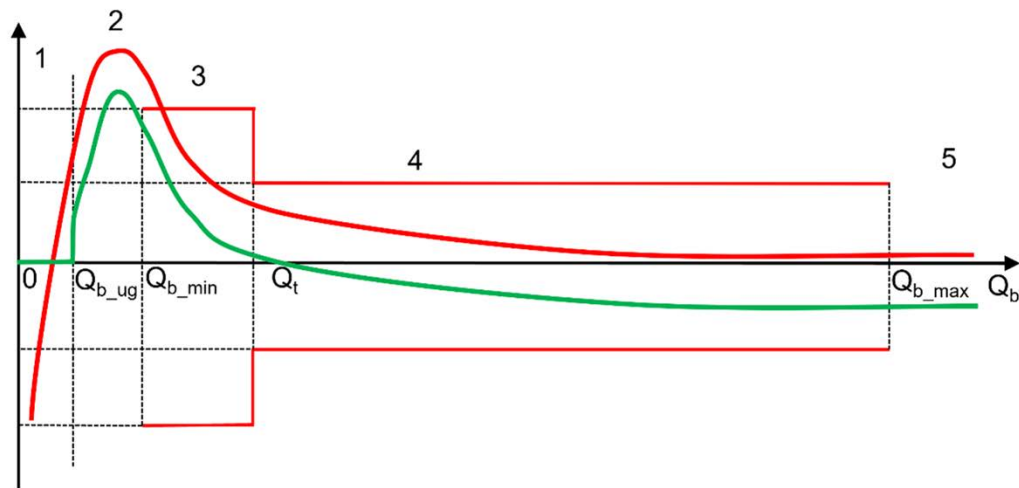
**Note**

**Under these specified conditions, the Reynolds correction can and should be applied to all variants of the RSM 200!**

**Only if very high-pressure fluctuations are present and / or the gas parameters deviate significantly from those of a natural gas H, this correction should be dispensed with for the RSM 200 VM and RSM 200 VMF.**

### 3.4. Measuring ranges and precision

The RSM 200 passed the upstream disturbance measurements according to OIML R137-1&2, Class 1 with slight and heavy upstream disturbances. The following figure explains the measuring ranges, terms, errors, and their effects:



**Figure 6: Measuring ranges**

The accuracy of RSM 200 is defined in the range of  $Q_{m\_min}$  to  $Q_{m\_max}$ . The relative deviation are:

< 0,33 % in the range of  $Q_t$  to  $Q_{m\_max}$  range 4

< 0,67 % in the range of  $Q_{m\_min}$  bis  $Q_t$  range 3

$Q_{m\_min}$  is the lower limit of the range of use of RSM 200,  $Q_{m\_max}$  the higher limit.  $Q_t$  is the measuring range transmission value; this value is set as 10% of  $Q_{m\_max}$ .

Below  $Q_{m\_min}$  and above  $Q_{m\_max}$  no error is defined, between 0 and  $Q_{m\_min}$  and above  $Q_{m\_max}$  the RSM 200 - depending on the measurement conditions - can still measure a flow rate.

In order to ignore undefined flow rate variations below  $Q_{m\_min}$ , a configurable low flow cut-off  $Q_{m\_ll}$  is introduced. Below this value the measured value is set to = 0. It is usually recommended to set the low flow cut-off  $Q_{m\_ll}$  to  $0.25 \times Q_{m\_min}$  (factory setting).

As explained in the *chapter 3.3 Basic curve and Reynolds number*, the measured values are corrected by a correction polynomial in the measuring range; in the figure the red curve is shifted towards the green ones, and corrected. The correction of the measured values by the polynomial is not continued below  $Q_{m\_min}$  and above  $Q_{m\_max}$ ; however, the outermost value in each case is frozen. Above  $Q_{m\_max}$ , the correction value of  $Q_{m\_max}$  is a fixed value; the same applies below  $Q_{m\_min}$ .

## Error handling

- (5) If the (corrected) measured value  $Q_m$  is above  $Q_{m\_max}$  then an alarm is generated and the volume counting takes place in the error counter of  $Q_M$  (counter see *chapter 6.4 Counters, archives*).
- (3, 4) Exceeding the measuring range (red limit lines) of the original measured values does not cause an alarm and the volume counting takes place in the undisturbed counter (counter see *chapter 6.4 Counters, archives*) of  $Q_m$ .
- (2) No error is defined below  $Q_{m\_min}$ ; the green, corrected measurement may exceed the error limits (here 0.67 %).
- (2) If the measured value  $Q_m$  is between  $Q_{m\_ll}$  and  $Q_{m\_min}$ , then no alarm is generated. At the same time a timing is started. As long as this time measurement is smaller than **B09 Max.T  $\geq Q_{m\_ll} + < Q_{m\_min}$**  it is still counted into the undisturbed counters. If this time is exceeded an alarm is triggered and volume counting takes place in the error counter.
- (1) Below the low flow cut-off  $Q_{m\_ll}$  the volume flow rate is set to 0; volume counting from 0 does not take place. An alarm is also not triggered.

Special cases are present for 3 settings of the low flow cut-off  $Q_{m\_ll}$ :

- $Q_{m\_ll} = 0$ .  
This setting implies that the low flow cut-off treatment acts on negative values below 0. Thus - despite a direction detection of the flow in coordinate **I04 Flow direction forward / backward** no negative flows are calculated, means these are set to 0. These are not recorded, i.e., they are neither counted in the undisturbed counter nor in the disturbance counter. An alarm is not triggered, too.
- $Q_{m\_ll} = Q_{m\_min}$ .  
This makes timing and control obsolete. An alarm is not generated.
- $Q_{m\_ll} > Q_{m\_min}$ .  
This setting is not permitted.

The following table shows the flow rate ranges of the RSM 200.

	Flow rate				Gas speed in the incoming pipe <sup>*1)</sup>			
	Q <sub>max</sub> [m <sup>3</sup> /h]	Q <sub>t,min</sub> [m <sup>3</sup> /h]	Q <sub>min</sub> [m <sup>3</sup> /h]	Q <sub>m,ll</sub> <sup>*2)</sup> [m <sup>3</sup> /h]	v (Q <sub>max</sub> ) [m/s]	v (Q <sub>t,min</sub> ) [m/s]	v (Q <sub>min</sub> ) [m/s]	v (Q <sub>m,ll</sub> ) [m/s]
<b>DN50</b>	160	16.0	1.0	0.25	22.64	2.26	0.14	0.035
<b>DN80</b>	400	40.0	2.5	0.63	22.10	2.21	0.14	0.035
<b>DN100</b>	650	65.0	3.2	0.80	22.99	2.30	0.11	0.028
<b>DN150</b>	1600	160.0	8.0	2.00	25.15	2.52	0.13	0.033
<b>DN200</b>	2500	250.0	13.0	3.25	22.10	2.21	0.11	0.028

31

---



---



---

\*1) Simplified, the inner diameter Di of the incoming pipe was equated with the value of the

nominal diameter; i.e. Di (DN50) = 50 mm = 0.05 m, and so on.

\*2) Here the recommended setting for the low flow cut-off was selected (Q<sub>m,ll</sub> = 0.25 x Q<sub>min</sub>).

**Table 3**

Q<sub>min</sub> is valid up to 4 bar(a). Above this pressure, testing is only possible up to 5 m<sup>3</sup>/h in air, and up to 3 m<sup>3</sup>/h in natural gas (as of June 2023).

The measuring range of the RSM 200 covers a dynamic range of approx. 200 for large nominal diameters. For small nominal diameters, the dynamic range is approx. 160. If measurements are mainly taken in the lowest measuring range for small nominal diameters, a calibration of the calibration points covers this range better than the polynomial correction, which is preferable in the middle and upper measuring ranges. If the meter is used in the whole measuring range the polynomial correction should be used in general, too.

**Note**

**In case of disturbed signal evaluation, e.g., high flow rate or high CO<sub>2</sub> gas content, an optimized signal evaluation automatically extends the measuring range. Operation in this range will cause a warning and increased power consumption or shorter battery life can be expected.**

### 3.5. Mounting the RSM 200 into the pipeline

RMG's RSM 200 is equipped with connection flanges. For a secure connection, the connection dimensions of the flanges of the pipelines to be connected must match the connection dimensions of the flanges of the device.

32

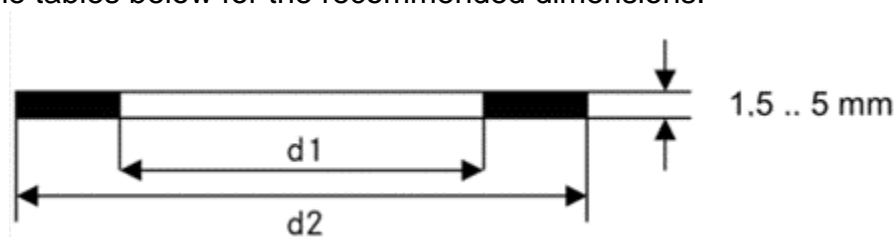
- ANSI pressure stages: Flange connection dimensions correspond to the standard ASME B 16.5.
- DIN pressure stages: Flange connection dimensions correspond to the standard DIN EN 1092.

#### 3.5.1. Seals

**Flat seals** (EN 12560-1 Form IBC)

Characteristic values:  $k_0 \times K_D = 20 \times b_D$  |  $k_1 = 1,3 \times b_D$  [N/mm]

Refer to the tables below for the recommended dimensions.



**Figure 7: Flat seal**

DN		d1	d2	PN 10	PN 16	ANSI 150
50	2"	61	107	107	107	105
80	3"	90	142	142	142	137
100	4"	115	162	162	162	175
150	6"	169	218	218	218	222
200	8"	220	273	273	273	279

**Table 4**

#### Note

If flow rate meters use flange seals that protrude into the pipeline, the measurement accuracy may be affected. Ensure that the flange seals do ***not*** protrude beyond the seal surfaces into the pipeline.

**Malfunctions can occur with incorrect seals.**



**⚠ Danger**

If incorrect flange seals are used during assembly, leakage, i.e. gas leakage, can result in an explosive gas mixture. Danger of poisoning and explosion!

In addition, the load on the flange may be inadmissibly increased when the bolts are tightened.

Ensure secure fastening/attachment of the RSM 200 during assembly in order to avoid crushing. Ensure that you keep your fingers (or other body parts) away from these openings and gaps when pulling the flanges together.

33

---



---



---



---

### 3.5.2. Screws and torque

DN	Pressure stage	Seals	Size of screw	Material	Torque *2	
50	2"	PN 10	Flat seal	4 x M16	25CrMo 4 (1.7218) DIN EN 10269	66 Nm
		PN 16	Flat seal	4 x M16	25CrMo 4 (1.7218) DIN EN 10269	66 Nm
		ANSI 150	Flat seal	4 x 5/8"	25CrMo 4 (1.7218) DIN EN 10269 and SA-193 (M) Gr. B7, G41400	56 Nm
80	3"	PN 10	Flat seal *1	8 x M16	25CrMo 4 (1.7218) DIN EN 10269	66 Nm
		PN 16	Flat seal *1	8 x M16	25CrMo 4 (1.7218) DIN EN 10269	66 Nm
		ANSI 150	Flat seal *1	4 x 5/8"	25CrMo 4 (1.7218) DIN EN 10269 and SA-193 (M) Gr. B7, G41400	125 Nm
100	4"	PN 10	Flat seal *1	8 x M16	25CrMo 4 (1.7218) DIN EN 10269	71 Nm
		PN 16	Flat seal *1	8 x M16	25CrMo 4 (1.7218) DIN EN 10269	71 Nm
		ANSI 150	Flat seal *1	8 x 5/8"	25CrMo 4 (1.7218) DIN EN 10269 and SA-193 (M) Gr. B7, G41400	76 Nm
150	6"	PN 10	Flat seal *1	8 x M20	25CrMo 4 (1.7218) DIN EN 10269	122 Nm
		PN 16	Flat seal *1	8 x M20	25CrMo 4 (1.7218) DIN EN 10269	122 Nm

		ANSI 150	Flat seal * <sup>1</sup>	8 x 3/4"	25CrMo 4 (1.7218) DIN EN 10269 and SA-193 (M) Gr. B7, G41400	135 Nm
200	8"	PN 10	Flat seal * <sup>1</sup>	8 x M20	25CrMo 4 (1.7218) DIN EN 10269	175 Nm
		PN 16	Flat seal * <sup>1</sup>	12 x M20	25CrMo 4 (1.7218) DIN EN 10269	117 Nm
		ANSI 150	Flat seal * <sup>1</sup>	8 x 3/4"	25CrMo 4 (1.7218) DIN EN 10269 and SA-193 (M) Gr. B7, G41400	188 Nm

\*<sup>1</sup> Flat seal expanded graphite with metal insert

\*<sup>2</sup> Torque for solid shaft bolts /- screws acc. to AD2000 / ASME

**Table 5**

**Note**

**The approved temperature range for bolts and nuts made of material 25 CrMo 4 (1.7218) DIN EN 10269 and SA-193 (M) Gr. B7, G41400 is -40°C to +80°C.**

35

The durability of the flange connection was verified using the screws listed in this chapter in combination with the seals listed in the previous chapter with the following maximum material characteristic data according to AD200 and ASME rules and regulations. Other screw/flange variants were not tested.

### 3.5.3. Installation

**Note**

**Do not install devices that interfere with the gas flow directly in front of the measuring instrument.**

**The RSM 200 must be protected from solid particles that may be contained in the gas flow. The particle size of such foreign bodies must be smaller than 5 µm.**

The RSM 200 can be used without further inlet section, if only mild disturbances according to OIML are present. Even severe disturbances according to OIML (room elbow with half-moon orifice, sudden expansion), influence the accuracy only within permitted limits (of the specified accuracy class), if an inlet distance of at least 2 x DN is maintained.

The inlet path must be designed as a straight pipe section with the same nominal width as the RSM 200. Behind the RSM 200 there must be a straight pipe or fitting (elbow) of the same nominal size with a total length of 2 x DN (along the pipe axis).

Temperature measuring devices may only be installed at a distance of 1,5 x DN behind the RSM 200.

### **⚠ Danger**

Protect the flow rate meter from damage caused by very heavy fluctuations in the flow, e.g., if the downstream pipeline system is filled or blown off.

Welding on the line must only take place at a safe distance from the device. Extreme temperatures in the line near the flow rate meter can cause permanent damage.

Make all electrical connections of the flow rate meter according to the installation instructions. Ensure that the connections are intrinsically safe.

### **⚠ Caution**

Liquids in the line after a hydrostatic test can damage the inside of the device.

If hydrostatic testing is necessary, the meter must be replaced with a pipe section. Ensure that there is no liquid remaining in the line above the the meter after the hydrostatic testing.

#### 3.5.4. Threshold values

The following threshold values are recommended for maximum durability and the highest measuring accuracy:

<b>Maximum short-term overload</b>	$Q_m < Q_{m\_max} + 20\% \times Q_{m\_max}^{*1)}$
<b>Maximum flow rate changes and/or impact loads</b>	arbitrary flow changes, (also) caused by pressure pulses, are allowed <sup>*2)</sup>
<b>Maximum pressure change</b>	< 0.1 bar/sec
<b>Maximum flow pulsation:</b>	Pulsations of the flow should have small amplitudes and frequencies below 0.1 Hz

<b>Particle size in the gas flow:</b>	< 5 µm
<b>Mechanical vibration</b>	< 1 mm/sec (vibration speed)

\*1) Do not start the RSM 200 at  $Q_{max}$ ! If the overload is reached during continuous operation failure of the RSM 200 is possible but unlikely. A start under these conditions can lead to a longer start-up phase, as there may be difficulties in finding the first signal. A flow rate measurement above  $Q_{max}$  will generally give useful results, but this is not guaranteed. Mechanical damage to the device is however excluded.

\*2) Frequent large flow rate changes result in increased computing requirements, which can reduce battery life.

**Table 6**

These measures must be determined and checked during commissioning, before filling, during the start-up and run-in phase of the meter and evaluated, in particularly with simultaneous occurrence of multiple of these threshold values. Intervention in the system for improvement of measuring conditions must be carried out when the aforementioned threshold values are reached.

**Note**

The operator should record measurement and operating data throughout the operation. This may enable the causes of damage to be identified at an early stage and remedied in good time. Remedy and/or relief of critical operating statuses can be achieved, for example, with the following measures:

- Start-up screen (MW < 0.15 mm)
- Filter
- Check valves (pulsation, backflow)

**3.5.5. Technical guideline G13**

The RSM 200 is often used in place of turbine wheel gas meters. The additional rectifiers and inlet sections suggested for the safe operation of turbines can remain in the line, no worsening of the measurement results of the RSM 200 must be expected.

### 3.5.6. Pressure loss

The pressure loss is approx. 40 % of the pressure loss of a turbine of the same nominal size. Measuring points 1 x DN upstream and downstream of the meter are used to determine the pressure loss. The pressure loss  $\Delta p$  [mbar] is calculated according to the following formula:

$$\Delta p = Z_p \cdot \rho_m \cdot \frac{Q_m^2}{DN^4}$$

where:

$Z_p$  = Pressure loss coefficient

$\rho_m$  = Measurement density [kg/m<sup>3</sup>]

$Q_m$  = Measurement volume flow rate [m<sup>3</sup>/h]

$DN$  = Nominal meter width [mm]

The pressure loss coefficient  $Z_p$  for turbines is typically around 5000, while the RSM 200 only has a value of around 2000.

#### 3.5.6.1. Commissioning the device

##### Note

**You receive the RSM 200 parameterized and calibrated according to your specifications.**

**All further adjustments and corrections are made in-house at RMG. The device operator receives a completely preset, ready-to-use measuring device that does not require any further presettings regarding ultrasonic measurement.**

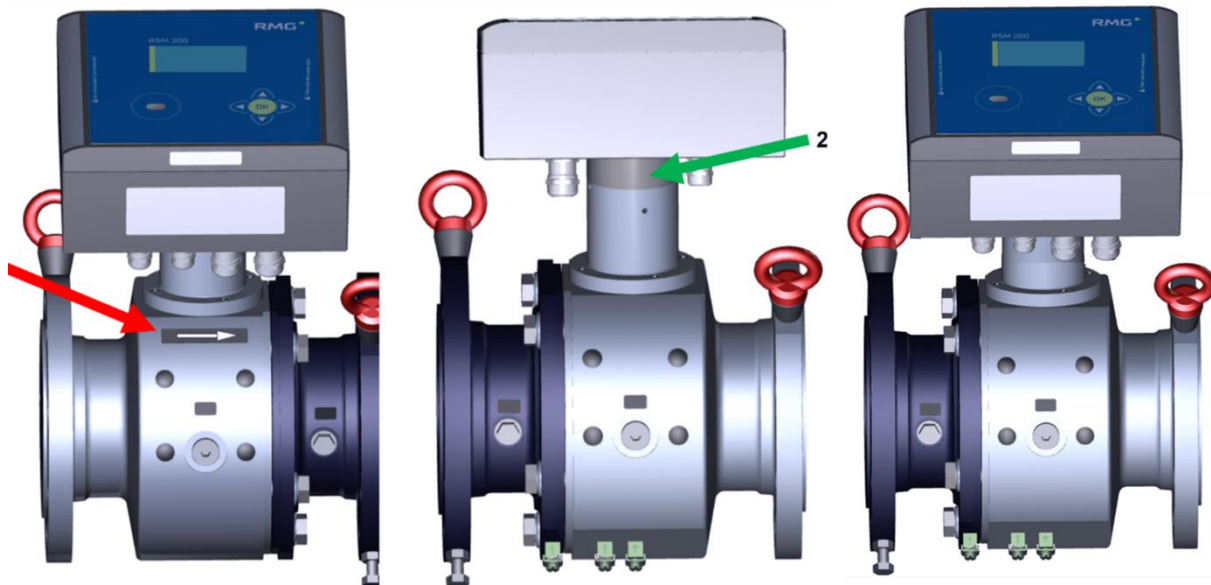
**Some of these setting parameters are not accessible to the device operators and are adjusted - if necessary - by RMG Service.**

Nevertheless, check that these settings match your defaults and, if necessary, select the smallest possible pulse width at which the low frequency output will work in your pulse recording.

### 3.5.7. Rotating the display

The RSM 200 is offered in 2 versions; first, the display faces you and the flow direction is from the left side to the right side. Second, the flow direction is reversed. In the *Figure 8: Rotating the display* the red arrow (1) indicates the flow direction for

version 1. The display is tilted downwards at the front, so rainwater runs off and readability from the front is improved.



**Figure 8: Rotating the display**

**Note**

Please make sure that you order the correct orientation of the flow rate meter.

However, the orientation can be easily changed. The extension on the plug-in axle, green in the illustration (2) between the measuring device and the electronics must be turned 180° for this purpose. In doing so, the device loses neither its calibration nor its parameterization. The measuring device on the right side of figure 8 shows the changed orientation.

**Note**

During installation, ensure that the display and type plate can be read. Prevent reading from being obstructed by light (e.g., strong lamp, sun) or shade (e.g., installation in front of a wall).

## 4. Installation

### 4.1. Electrical connections

40

**⚠ Danger**

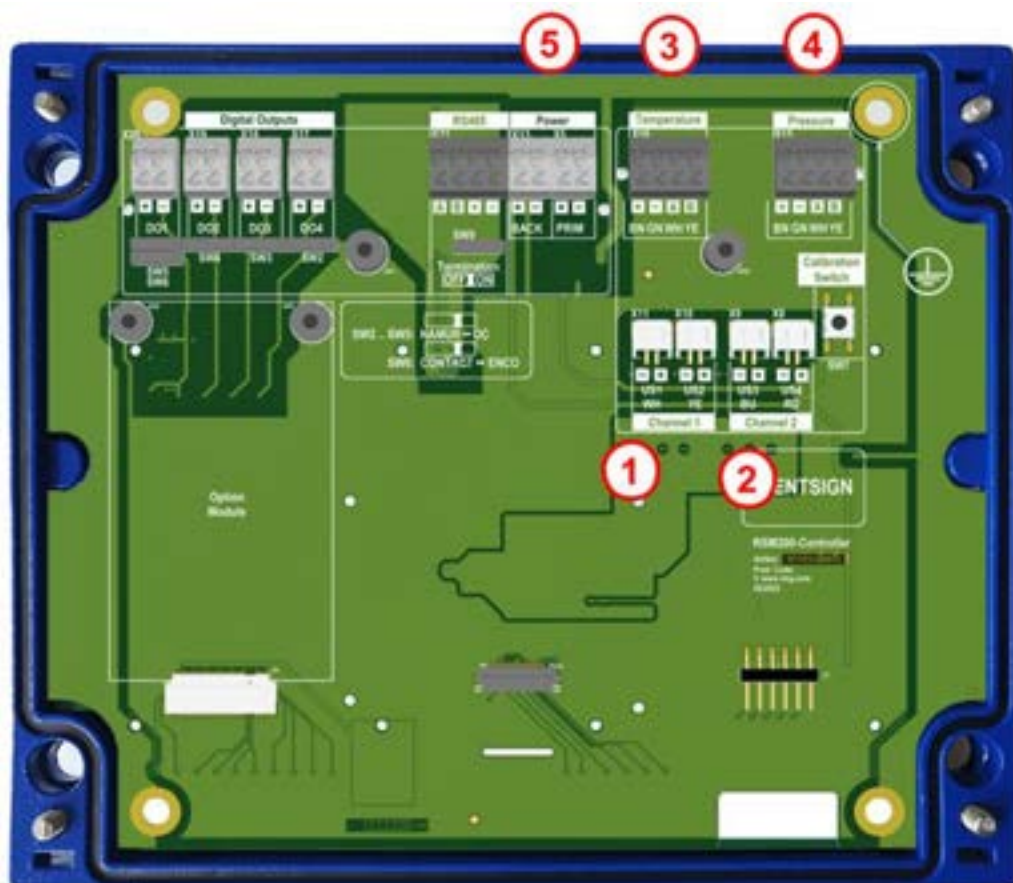
Please follow all explosion proof regulations listed in the first chapter. Only trained personnel may perform the following work!

Open the cover of the RSM 200 order to reach the electrical connections.



*Figure 9: Unscrewing the screws to open the cover*

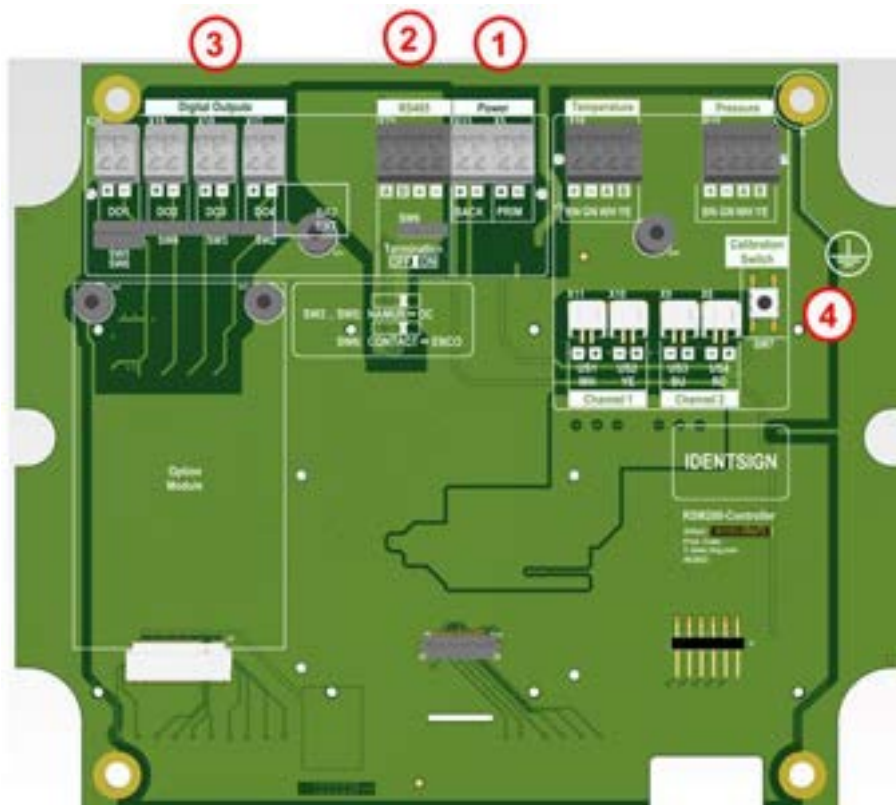




**Figure 10: Internal terminal assignment of the RSM 200**

The terminals marked 1 - 5 are usually already connected at the factory:

- 1     Ultrasound sensors channel 1 (terminal X10 and X11)
- 2     Ultrasound sensors channel 2 (terminal X8 and X9)
- 3     Temperature sensor (EDT-87) (terminal X16)
- 4     Pressure sensor (EDT-96) (terminal X15)
- 5     Battery (terminal X5)



**Figure 11: Internal terminal assignment of the RSM 200**

- |                                  |                                      |
|----------------------------------|--------------------------------------|
| 1 Power supply (terminal X5)     | 3 Digital outputs (terminal X17-X20) |
| 2 Interface RS485 (terminal X21) | 4 Calibration switch                 |

The terminals marked 1 - 3 (terminal X5, X21 and X17 to X20) must be connected by the customer. Refer to *Figure 11: Internal terminal assignment of the RSM 200* for the assignment. The connection of internal sensors (e.g. ultrasonic sensors [Channel 1, ..], pressure and temperature) has already been carried out at the factory in accordance with applicable regulations.

#### 4.1.1. Power supply

There are different ways to supply power to the RSM 200:

1. Battery mode (terminal X5)
2. External power supply (terminal X5)

In battery mode, both battery compartments are usually fully loaded, i.e. in *Figure 17: Location of the battery compartment* 6 batteries are inserted. Only with 6 batteries the lifetime of more than 5 years can be achieved. During operation, the batteries in PRIM (terminal 5) are used first, then BACK (terminal 13) when the voltage falls

below an internally set threshold. If BACK falls below this threshold, too, it is switched back again; this can happen several times at the end of the battery life. The battery symbol in the upper left corner of the display indicates the battery status. If the remaining capacity falls below 10%, a warning is issued.

Under "Power, PRIM" the RSM 200 can be powered externally with 6-30 VDC instead of the internal battery "PRIM". Equipping BACK with 3 batteries is strongly recommended, as this supply via BACK serves as a backup supply in the event of a power failure of the external supply.

### 4.1.2. Digital communication

If digital communication is desired with the RSM 200, which is mains powered, then this can be connected to the RS485. The differential signals are received via the data cables A and B with RS-485. Please also look out for reversed signal lines and replace the connections as necessary. Digital communication via RS485 requires a separate external power supply to be connected to + and - (under RS485). The interface is to be supplied galvanically isolated.

If required, the data interface can be conditioned by means of a switch under the connector. Normally, the resistance should be infinite ( $\infty \Omega$ ) (Termination off); for a point-to-point connection or if the terminal is part of a bus system, the resistance should be set to  $120 \Omega$  (Termination on).

### 4.1.3. DSfG F instance

The values of the F instance can be called up via the Modbus RTU protocol. The interface settings listed in section 6.8.8 must be made to be able to communicate via this.

The standard register addresses of the F instance defined according to DSfG can be viewed more conveniently using RMGViewRSM. These can be found in the "Values" tab under "V: ISO type label" and "W: ISO values" but cannot be changed (see section 6.6.8).

### 4.1.4. Digital outputs

The RSM 200 has 4 digital outputs DO1 to DO4. Various values can be obtained via these outputs:

**DO1:**

- Off
- Measurement volume NF
- Standard volume NF
- Alarm
- Alarm inverse
- Warning
- Warning inverse
- Frequency inverse HF + alarm
- Encoder protocol

**DO2:**

- Off
- Measurement volume NF
- Standard volume NF
- Measurement volume HF
- Alarm
- Alarm inverse
- Warning
- Warning inverse

The encoder output on DO1 is activated both via software parameters and with switch SW6.

**DO3:**

- Off
- Measurement volume NF
- Alarm
- Alarm inverse
- Warning
- Warning inverse

**DO4:**

- Off
- Standard volume NF

Depending on the power supply, certain output options are restricted. All options that are possible in battery mode are marked green.

The outputs DO1 to DO4 can be configured both as open collector outputs and as Namur outputs (switches SW2 to SW5).

According to the choice, there are further setting options.

**LF (Low frequency up to maximum 7 Hz)**

A pulse value LF is assigned to the pulses: e.g. 1 pulse per 1 m<sup>3</sup>. With a volume flow rate of 3600 m<sup>3</sup>/h, this results in 1 pulse per second. These low frequency pulses are not output as a fixed frequency (here 1 Hz), but as "pulse packets", i.e. sometimes more or less pulses, "only" on average results in 1 Hz. A pulse width is assigned to the pulses; 125 ms is recommended here, but larger values can also be set. Further recommendations for these low frequency settings are given in *chapter 6.8.16 Digital outputs*.

If the pulses are fed to a counter, then the values (measurement and standard volume flow rate) can be compared with the indication in the display of the RSM 200.

**HF (High frequency up to maximum 5,000 Hz)**

The measurement volume flow rate or a test frequency can be output on DO1. This output is superposed with the alarm, the latter having priority. DO2 is therefore

recommended as the output of the measurement volume flow rate. Here, too, a pulse value HF is assigned to the pulses; with e.g. 3600 pulses per 1 m<sup>3</sup>, the numerical value of the output frequency matches the numerical value of the measurement volume flow rate. To help determine a suitable pulse value HF, the display of the maximum output frequency, which results from the maximum measurement volume flow rate, is helpful. Here, care must be taken to ensure that the maximum frequency that exists at maximum flow is less than 5000 Hz; a maximum frequency of 4000 Hz is recommended here.

45

If the RSM 200 is to be used as a "**flow rate sensor**", the HF frequency output can be used for this purpose. This also makes control tasks possible.

**Alarm or warning outputs** operate on the closed-circuit current principle. The switching contact is closed during undisturbed operation.

DO1 allows the output of an ENCO protocol (typical for e.g. turbine wheel gas meters). For further information also see *Annex E Encoder protocol*.

### **Caution**

**The maximum values for the pulse outputs and the RS 485 can be found in the EC type examination certificate!**

#### 4.1.5. Analog output

The RSM 200 allows a 4...20 mA signal output.

This output is in preparation; more details will be available after completion.

#### 4.1.6. Connecting the cables

Use the wire end ferrules for the connecting cables and route them in from below; a seal holds the cable. To be able to pull a cable out again, press the small white square (marked with the X) down using a small screwdriver (at the bottom in *Figure 10: Internal terminal assignment of the RSM 200* and *Figure 11: Internal terminal assignment of the*; top of the plug strip) in order to open the locking device. Keep the square depressed and pull the cable out of the plug strip.

In case of further connections, please check the data and restrictions of the connected devices in the documentation of these devices.

**⚠ Caution**

The RSM 200 and devices to be connected do not have connectors that can prevent polarity reversal.

Pay careful attention to the correct connections!

**4.1.7. Cables**

Signal cables (LF output, HF output, current loop connection, control input) must have 2 or more wires twisted in pairs and shielded (LiYCY-TP). 4-wire twisted and shielded cables (LiYCY-TP) must be used for the data cables (RS-485).

The shielding must always be connected to ground on both sides - on the RSM 200 as described in *section 4.1.8 Cable connection*. Cable cross-sections of 0.5 mm<sup>2</sup> are recommended. Due to the cable screw connection, the outer diameter of the cable must be between 4.5 and 6.5 mm.

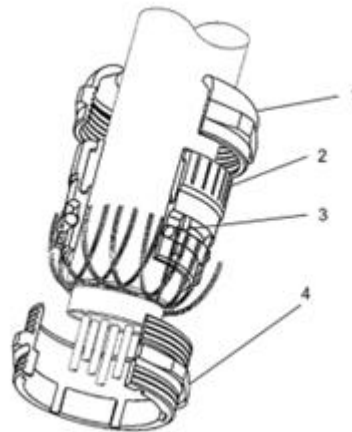
**⚠ Caution**

The maximum cable length is limited when used in explosion-prone areas due to the limit values for intrinsically safe current circuits and depending on the inductivity and capacity of the cable.

**4.1.8. Cable connection**

Clamp the shielding into the cable connectors as shown in the figure below:

- Unscrew the union nut.
- Pull the terminal insert out of the plastic.
- Slide the cable end through the union nut and the terminal insert and bend the shielding back.
- Plug the terminal insert back into the connecting piece.
- Tighten the union nut.
- Every explosion proof signal circuit must be routed with a dedicated cable which must be guided through the appropriate PG screw coupling.



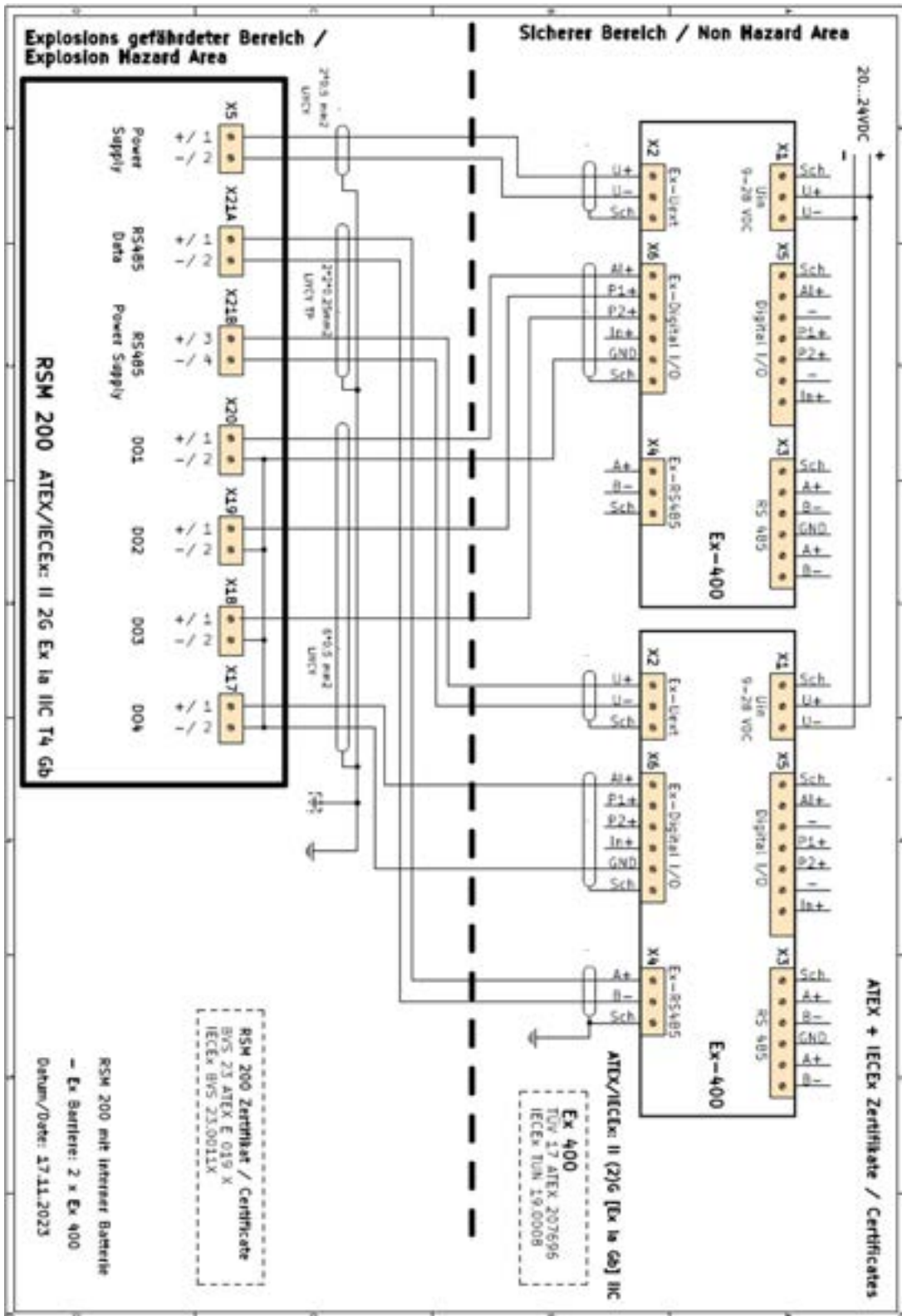
**Figure 12: Terminal screw connection**

- |   |                 |   |                  |
|---|-----------------|---|------------------|
| 1 | Coupling nut    | 3 | O-ring           |
| 2 | Terminal insert | 4 | Connecting piece |

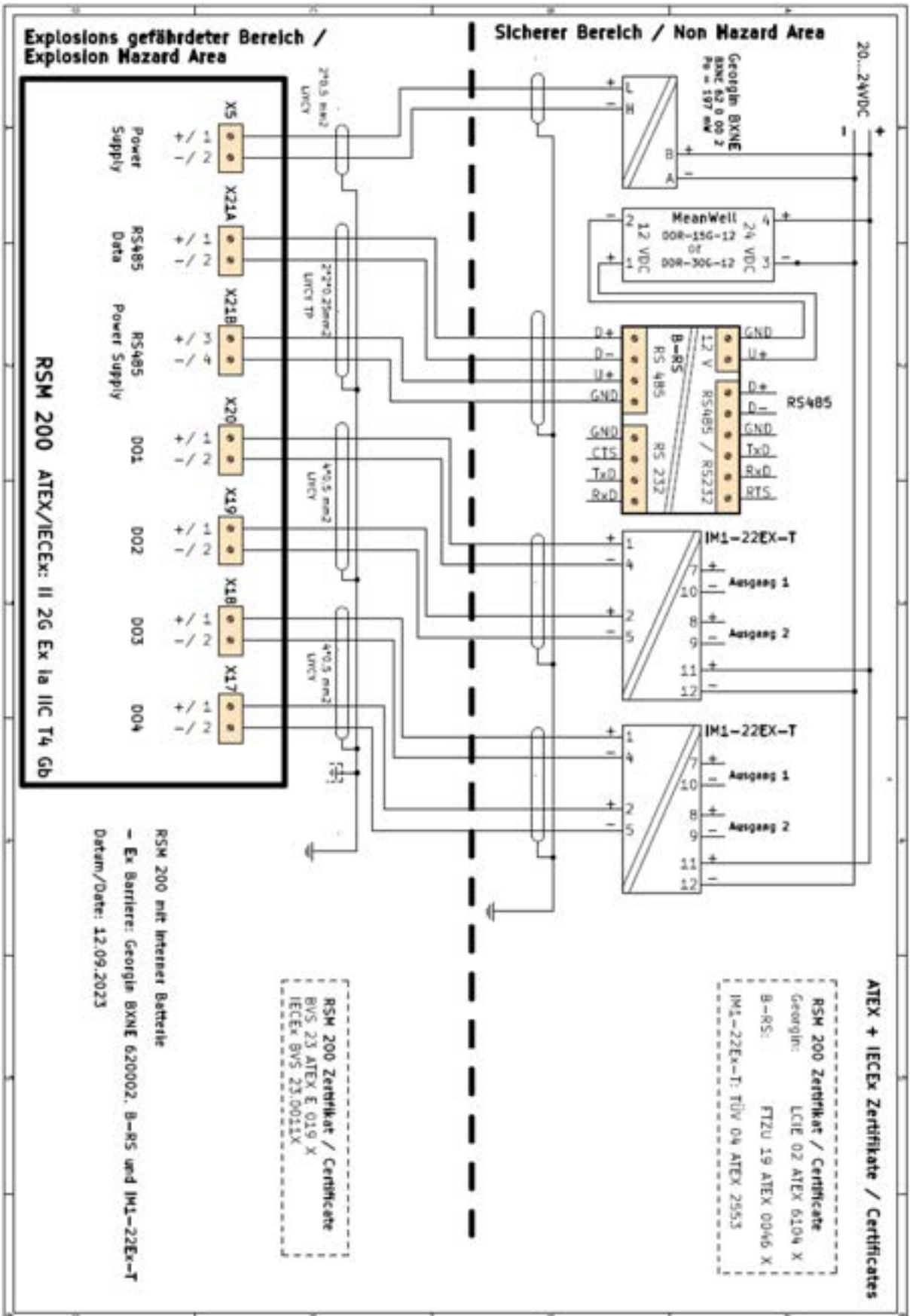
#### **4.1.9. Connection via separation barrier**

The next two figures show the possible connection of the outputs via two Ex-400 or via other Ex separation barriers.

### 4 Installation







#### 4.1.10. Grounding

##### Note

To avoid measuring errors due to electromagnetic interference, the meter housing must be grounded with the ground connection on the right section of the housing (see *Figure 13: Grounding of the measuring instrument*).

Furthermore, proper grounding can prevent static charges.

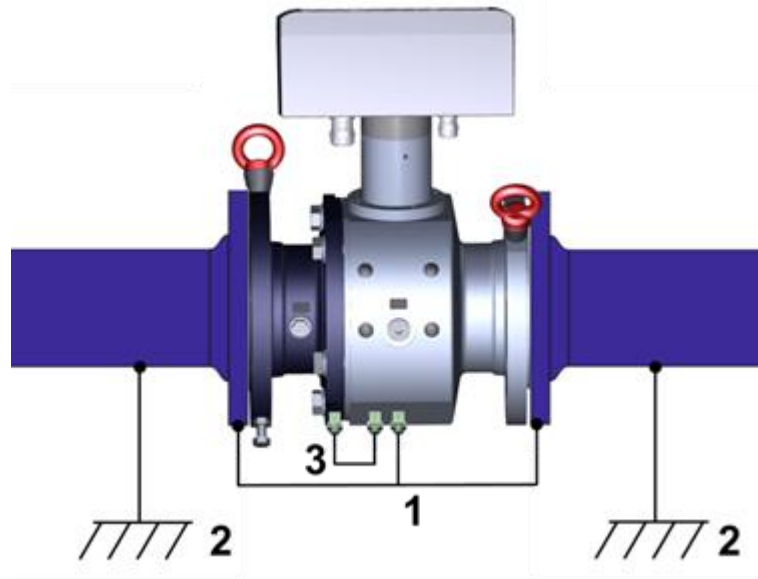
Minimum cable cross-section:

- length of up to 10 m: 6 mm<sup>2</sup>
- length of 10 m or higher: 10 mm<sup>2</sup>



**Figure 13: Grounding of the measuring instrument**

In the process, a conductive connection between the RSM 200 and the pipeline must be provided as shown in the figure below.



**Figure 14: Grounding with the connecting pipes**

- 1 Ground wire min. 6 mm<sup>2</sup>
- 2 Grounding measurement system
- 3. Internal grounding connection

## 5. Basic settings

### 5.1. Display field

The front of the RSM 200 shows a graphic LCD display (resolution: 128x24 pixels), 5 keys for setting the display and for parameterization and an area for activating a wireless infra-red data communication triggered by a reed contact.

52



**Figure 15: Display**

A display and the keyboard allow setting, parameterization of the RSM 200 and display of the status, measured data and measured values together with their

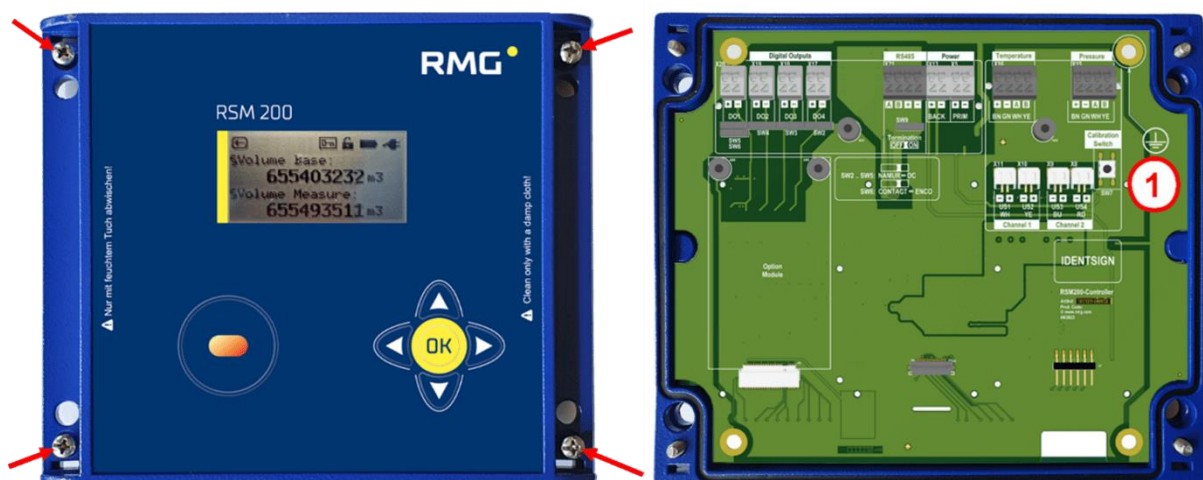
designation and unit. Here, the (summed) measurement volume and the present measurement volume flow rate can be seen as an alphanumeric display with the associated units [m<sup>3</sup> and m<sup>3</sup>/h].

In addition, the device indicates the state: open calibration switch and there is an external power supply. Depending on the previously selected display, the font size, character length and display may vary. The various display options can be selected using the control panel (see below).

The *chapter 6 Operation* explains how the RSM 200 can be set, parameterized and read out. Basically, the display shows the measured values, the meter reading and the status, supports the readout of the archives and allows the parameter settings.

### 5.1.1. Reset

In case of serious malfunctions, it may be necessary to restart the (entire) device and reset the parameters.



**Figure 16: Position of the calibration switch**

- 1 Calibration button, accessible after opening the cover of electronics

In the delivered condition, the calibration button is protected by a protective plate with a hole; it can be activated by pressing (with a pin) through the hole and the calibration seal.

### Caution

For resetting, it is necessary to remove seals, especially seals above the calibration key (see *Figure 16: Position of the calibration switch*).



The RSM 200 may only be used for custody transfer use with an intact seal. Removal or damage to seals normally entails considerable expenses!

The re-fitting of seals may only be carried out by an official authority or a custody transfer office!

### Note

When resetting, the current parameter settings are lost and are reset to the default values. Therefore, read out all parameters of the RSM 200 before re-setting. Counter readings are retained when resetting.

#### Proceed as follows to reset:

- Remove all voltage supplies from the RSM 200 (power and/or battery supply)
- Press the "left " and "right " buttons simultaneously
- Switch on the voltage again
- Release the depressed buttons.
- The following text appears in the display;  
„Reset device?.

Yes: Press cal. Switch

No : Press any key”

In order to "reset", the calibration button must be pressed. A previous calibration of the device is of course obsolete!

- The following display appears:  
“Reset device“
- The next step is to select the system of units:  
„System of units ?

Metrical: Press up

Imperial: Press down“

- Select your unit system and press the corresponding key.
- With the text:  
„set units

done“

the reset is finished and the start display appears with the counter reading of the

main totalizer with 0 m<sup>3</sup> if the metric unit system is selected or 0 cf if the imperial units are selected.

- Then, re-transmit all device parameters to the RSM 200 or enter the values from the test certificate.

### Note

The serial interface is set to 38400 Bps, 8N1, Modbus RTU after booting. These are also the default values of RMGView<sup>RSM</sup> (see *chapter 6.5 Operation with the PC software*).

55

The device is set to battery mode (factory setting) after the reset. The description refers to the IR interface; the onboard interface is deactivated.

### 5.1.2. Battery replacement

#### Danger

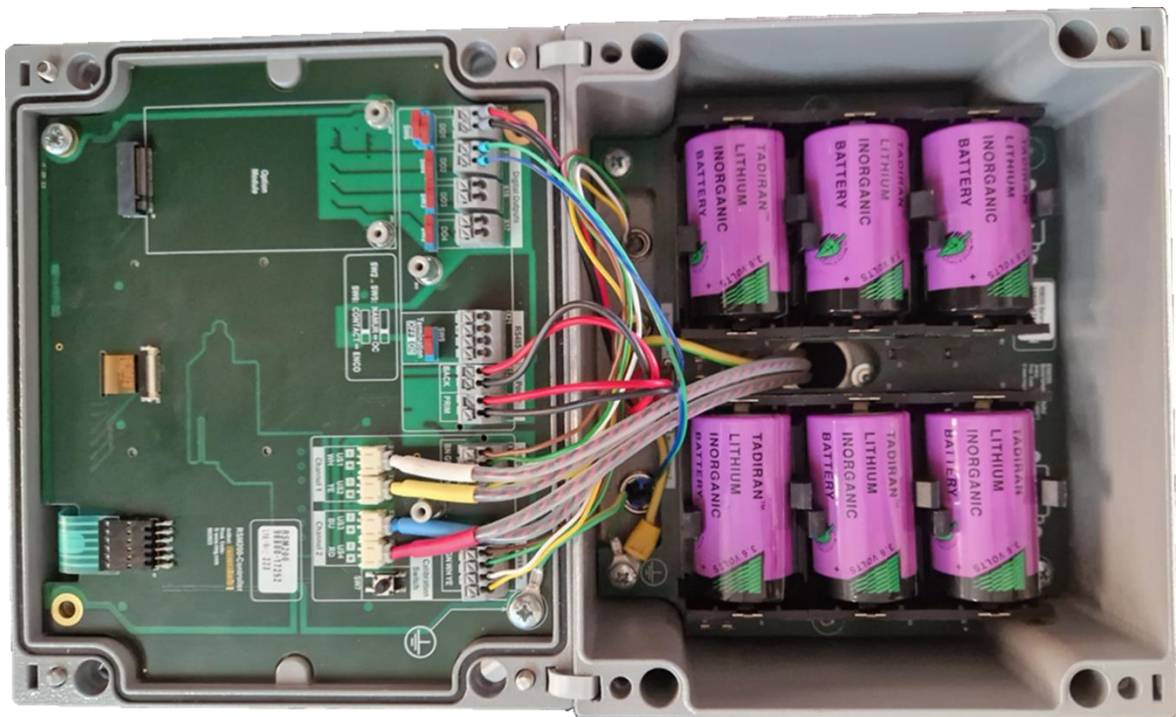
The battery must only be replaced in a non-explosive atmosphere. Ensure that the electronics are supplied with adequate ventilation with fresh air.

### Note

The RSM 200 internally determines the actual, average consumption, which may fluctuate slightly depending on the measuring point. On this basis, the service life, battery consumption and remaining runtime are extrapolated.

The coordinates G24 (see *chapter 6.8.7 Information*) indicate the remaining battery capacity. At the same time, the battery icon (top left) signals the status of the battery. If the remaining capacity falls below 10%, a warning is issued.

To change the battery, open the cover of the corrector as described above, *Figure 9: Unscrewing the screws to open the cover*. You will then have direct access to the batteries.



**Figure 17: Location of the battery compartment**

The batteries can be removed by pulling them upwards. When installing the new batteries, please make sure to keep the polarity of the new batteries.

### Note

The batteries can be changed during operation. If the batteries are changed in parts, i.e. first the three upper and then the three lower batteries (or vice versa), the recording will continue to run during the change.

- All meter readings and flow parameters are retained.
- The battery change must be indicated in coordinate G25. This updates the battery change date and sets the operating hours G26 to 0 and the battery capacity G24 to 100%.

You can also have the battery replaced by the RMG Service department; please contact RMG for this purpose (see page 2).

Please only use the battery types intended by RMG.

- XENO XL-205F
- TADIRAN SL-2780
- TADIRAN SL-2880

### Note



If the battery is not changed in parts, the device will stop measuring during the change.

- All meter readings and flow parameters are retained.
- After changing the battery, the current time and date must be re-entered and confirmed (coordinates X01, X02 and X03; see *chapter 6.8.19 Archive*). In addition, the battery change must be indicated in coordinate G25. This updates the battery change date and sets the operating hours G26 to 0 and the battery capacity G24 to 100%.

## 6. Operation

There are various ways to operate the RSM 200:

- via the keypad and display
- via the RMGViewRSM PC operating software, which is operated using the optical IR read head and a PC
- or via the on-board RS485 interface

The first two options are described more detailed in *chapter 6.5 Operation with the PC software RMGViewRSM* and *chapter 6.6 Menus and display structure*; the parameters and the associated Modbus addresses are listed in *chapter 6.8 Coordinates in context* and *appendix B Modbus*, so that appropriate operation is possible.

The operating options Battery mode, Mains operation and Test mode are described first. In normal operation, the RSM 200 runs in automatic mode without any further settings. The update rates for the automatic setting can be set; they are independent of whether mains operation, battery operation or test mode is selected. The output options are restricted.

The recommended update rates are based on the velocity fluctuations, the turbulence of the flow. In general, these are around / below 0.5% of the respective mean value. At an update rate of 4 Hz, the mean value is determined with an accuracy of approx. 0.03 % after only one minute, at 2 Hz below 0.05 % and at 1 Hz below 0.07 %.

The velocity fluctuations increase with velocities from approx. 30 m/s, which corresponds to velocities above 95% of  $Q_{max}$  at DN50, DN80, DN100 and DN200, at DN150 the value is approx. 85% of  $Q_{max}$ .

The velocity variations also increase below about 3 m/s, this is due to the resolution at small  $\Delta t$  at small velocities. These velocities correspond to flow rates below 10% of  $Q_{max}$ . If the RSM 200 is operated predominantly above or below this flow rate range, an update rate of 4 Hz is recommended for the flow rate, if the RSM 200 is operated only occasionally in these ranges, an update rate of 1 Hz is sufficient.



The following table contains recommended update rates, but you can change them if necessary.

	Mains mode	Battery mode	Test mode Mains or battery
Flow rate	4 x pro 1 s	1 x pro 1 s	4 x pro 1 s
Pressure	1 x pro 1 s	1 x in 30 s	1 x pro 1 s
Temperature	1 x pro 1 s	1 x in 30 s	1 x pro 1 s
Display	Switch-off after 60 sec.	Switch-off after 60 sec.	No switch-off

**Table 7**

## 6.1. Mains mode

Since energy consumption is subordinate in mains operation, the refresh rate can be set to the recommended values in *Table 7*. All outputs can be fully adjusted and used (see for ex. *chapter 4.1.4 Digital outputs* and *chapter 4.1.5 Analog output*). In addition, the onboard RS485 interface is available.

If the status of a currently displayed measured value is invalid, this is indicated by an arrow  in the upper left display field. By pressing the "left"  button, you can enter the event menu, where further information about the event (status, error, ...; see *chapter 8 Event messages* too) is displayed.

### Power failure with backup battery

If the mains supply fails, operation of the RSM 200 can be maintained with backup battery; for this purpose, battery compartment 1 must be filled with 3 batteries (see above). Measurements and data output are not interrupted in process. The battery symbol is displayed in this case. Usually a total bridging time of more than 3 months is achieved with 3 additional batteries for normally mains supplied devices as backup. For reasons of fail-safety of the RSM 200, this battery equipment is strongly recommended.

### Power failure without backup battery

In the event of a power failure to the RSM 200 without backup battery, operation, data recording and any output will be interrupted during the power failure. Archives, counter reading and parameterization are retained. After the power supply has been restored, both date and time must be reset and confirmed (see *chapter 6.6.7 Archive*).

## 6.2. Battery mode

Battery mode is usually set at the factory. After a reset (*chapter 5.1.1 Reset*), battery mode is also activated as the factory setting. If battery operation is to be set subsequently, this must be selected in coordinate **Z30 Power supply**. How the coordinate can be selected and changed and which access rights are required for this is explained at the end of this section 6.

For battery operation, the power requirement is minimized; the refresh rate should be set to the in recommended values in *Table 7*. In this operation, the battery life is more than 5 years. The RSM 200 internally determines the actual, average consumption. On this basis, the service life, battery consumption and remaining runtime are extrapolated.

### Note

**In battery mode, the IR read head should not be left "lying" on the RSM 200, as this results in increased power consumption (even without communication), combined with a shortened lifetime.**

The general measurement sequence is as follows:

1. System is in sleep mode and only operates the (LF) pulse output.
2. The measurement is started.
3. Sending and receiving the ultrasonic pulses.
4. Evaluation and calculation of measured values (and diagnostic values) of flow rate measurement under measurement conditions.
5. (Optional) measurement of pressure and temperature and calculation of compressibility and flow rate under standard conditions in the set update rate; in the meantime, the "old" value is kept.
6. Calculation of the new, additional counter pulses.
7. Updating and storage of flow rate values; if necessary, storage in the archives at the set storage interval.
8. Device goes into sleep mode.
9. Start of the next measurement.

The following activities will continue to be performed in sleep mode:

- The keyboard is monitored, and operation is activated when any key is pressed.

- If the contact of the IR interface is activated, further operation is also possible, i.e., communication with the RSM 200 via RMGView<sup>RSM</sup>. The RSM 200 works as in mains operation when the magnetic head is attached.
- Incoming Modbus telegrams on the serial interface are buffered and processed with the next measuring cycle. A reply telegram is output with the following measuring cycle at the earliest.
- DO 1 can be used as a serial interface (ENCO protocol). The device ID and the meter reading are output.

The following outputs are **not** possible in battery mode:

- HF output to DO 1 or DO2
- Onboard RS485 interface
- Analog output
- Alarm or warning messages

## 6.3. Test mode

The test mode can be activated both in mains operation and battery operation. This allows tests and inspections, e.g. calibrations to be carried out on the test bench. To activate it is necessary to enter the password (see *chapter 6.6.9 Access protection*). The test mode can be activated for different durations, 1, 2 or 5 hours.

### Note

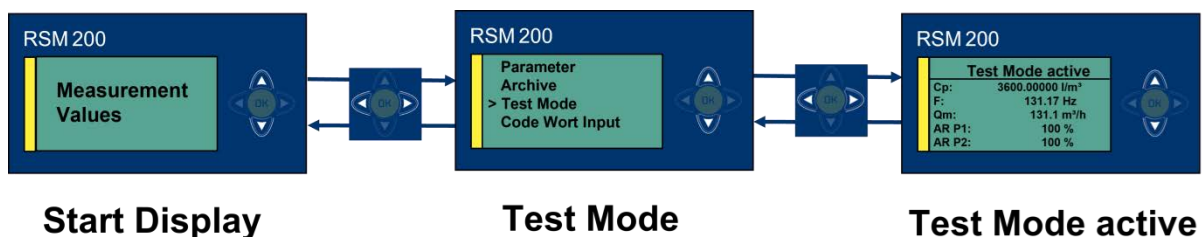
**The test mode has a high energy requirement. If it is used frequently / for a long time, the battery life will be reduced in battery mode. A battery life of 5 years may then no longer be achieved!**

When the test mode is started, the calibration switch and codeword level are reset (i.e. calibration switch is set to off; codeword level is at monitor level).

### Note

**When the test mode is activated, the display remains active and access to other settings is blocked. Required settings, e.g., settings of the pulse valency of the (HF) frequency output, ... must therefore be made before activating the test mode.**

In *Figure 29: Display settings and operation* it is shown how to switch to the test mode. This test mode can also be selected in the **Z Settings** menu in the **Z24 Test mode** coordinate; it can be activated for the duration of 1 hour, 2 hours or 5 hours.



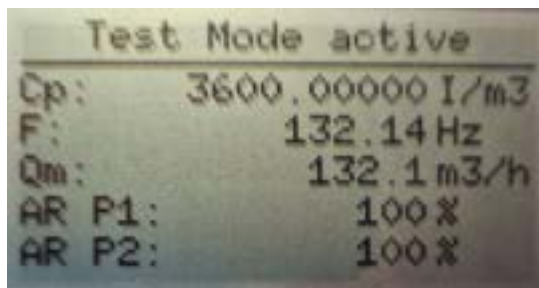
**Figure 18: Test mode**

The RSM 200 displays the test mode as undisturbed operation and counts accumulating volumes into the measurement volume counters or the standard volume counters.

The RSM 200 does not allow parameter changes (at configurator level) via the display and the 5 operating keys. To do this, the test mode must first be exited again. Nevertheless, even during the test mode, it is possible to press the calibration switch (again) or to increase the codeword level to Configurator in order to make changes to the parameters.

The test mode can be terminated at any time. After the test duration has elapsed, the RSM 200 switches back to the previously used operating mode; in battery operation, this is the energy-saving mode.

If the test mode is activated, then the display shows "Test mode active" and set parameters and measured values. The display can only be switched between the test mode activation display and the test mode measured value display. The measured value display shows 5 values per page in test mode. If the device operates with a volume corrector, the operating keys (up, down) can be used to change the displayed page.



**Figure 19: Activated test mode**

**Display without quantity transformer**

- Counter factor  $C_p$   
(HF, number of pulses per 1 m<sup>3</sup>)
- DO 2 (frequency, HF)
- Measurement flow rate
- Acceptance rate path 1
- Acceptance rate path 2

**Display with quantity transformer**

- Counter factor  $C_p$   
(HF, number of pulses per 1 m<sup>3</sup>)
- DO 2 (frequency, HF)
- Measurement flow rate
- Acceptance rate path 1
- Acceptance rate path 2
- Standard flow rate
- Pressure
- Temperature
- K number
- Z real gas factor

The following activities are performed in test the mode:

- Output of (HF-) pulses via DO 2
- The output at all other digital outputs and via the analog output are disabled; i.e., further alarm and warning messages are not emitted.
- Accumulating volumes are stored both in the volume counters / counter archives.
- Operation via the IR interface with RMGView<sup>RSM</sup> is possible if the display button or code word are activated again.

The following outputs are not possible in battery mode:

- Further operation of the RSM 200 via the RSM 200 keyboard is blocked until the test mode is terminated.
- Incoming Modbus telegrams are only processed if they are not under calibration switch or codeword protection. Calibration switch and codeword can be activated if necessary - as already mentioned above.



## 6.4. Counters, archives

The measured data and parameters can be read on the display and stored in the counters and archives. The illustration of the archives can be read in *chapter 6.6.7 Archive* below.

### 6.4.1. Counters

The RSM 200 stores the occurring volume flow rates in non-erasable counters, in the event of a power supply failure these are retained. The counter is unidirectional, i.e., negative volume flow rates are not counted.

$V_m$	accumulating measurement volumes, Gas volumes accumulated under measurement conditions (existing pressure and temperature), without erroneous measurements in the measuring range.
$V_b$	accumulating standard volumes, Gas volumes converted from the measurement volume to standard (base) conditions (e.g. 0°C and 1013 mbar); without false measurements in the measuring range
$V_{m\ err}$	disturbed, accumulating measurement volumes, Gas volumes accumulated under measurement conditions (existing pressure and temperature). Usually the measuring range is exceeded; in case of a failure of the pressure or temperature measurement, counting continues in $V_m$ .
and $V_{b\ err}$	disturbed, accumulating standard volumes, Gas volumes calculated from measurement conditions. Usually there are disturbed pressure or temperature measurements, or the determination of the real gas factor is disturbed. In these cases, counting is done in $V_{b\ err}$ but not in $V_{m\ err}$ . If a reference measurement is available for the disturbed measured variable (e.g. an alternative temperature measurement), then the correct standard volumetric flow rate can be recalculated.

The counters are saved every 30 s. The data records are secured with a checksum, which is checked during readout. Further information on the counters can be found in *annex A Counters*.

If there is a reverse flow, i.e., a negative velocity, then this reverse flow is detected, displayed in **coordinate I04 Flow direction** as "reverse" and a warning message is triggered.

A flow calculation does not take place; any flow that is lower than the low flow cut-off limit is set to 0 m<sup>3</sup>/h, even if the low flow cut-off limit is equal to 0 m<sup>3</sup>/h. Counting into

the counters is obsolete at 0 m<sup>3</sup>/h; the counters are only filled further if the flow rate is positive above the low flow cut-off limit.

### Note

The counters cannot be cleared.

Switching the units e.g. metric to imperial units (see *chapter 6.8.18 Unit system*), changing the resolution of the exponent (see *chapter 6.8.1 Volume / Counters*) or changing the volume counting mode (see *chapter 6.8.20 Settings*) is documented in the event archive. The last value is stored in the counters; the counter reading is not deleted in case of the listed events.

Since no conversion of the volume flow rates is available up to this point takes place, it is to be expected that the total value in the counters is incorrect; in the case of a settlement, the "old" counter reading must be deducted.

## 6.4.2. Archive

There is an event archive, a parameter archive, custody transfer (E) and non-custody transfer, a period archive, a daily archive and a monthly archive. The different archives can be read out and the content can be shown on the display. The presentation of the archives and information about the data stored there can be found in the *chapter 6.6.7 Archive*. The main data stored in the archives are:

Event archive	Errors, warnings, and hints
Parameter archive (non-custody transfer) (RSM 200 VM F and RSM 200 VC F also custody transfer)	Old and new parameter value
Periodical, daily and monthly archive  With the RSM 200 VC variants also	Measurement Volume, Measurement Volume Error  Standard volume, standard volume Er- ror, pressure, temperature, compressibility

**Note**

**No real-time clock is implemented in the RSM 200. The time is derived from the clock; it is used to derive the time stamps of the archive entries.**

**The clock and the date must be reset and confirmed after an interruption of the power supply.**

67

If the official parameter archive is full (= 300 entries), then the last 300 entries are retained and no new entries are added. The parameters relevant to calibration are stored in a non-volatile memory (EEPROM) and are retained there in the event of an interruption to the power supply (e.g., in the event of an improperly performed battery change).

The other archives are built as ring buffers; if the archive is full, then the oldest entry in the ring buffer is overwritten. All archives can be deleted (after activating the calibration switch), both individually and all together.

In *annex D Structure of the archives* you will find more information about the archives: Archive size, archive types, archive header and reading out the archive data via Modbus or RMGView<sup>RSM</sup>.

## 6.5. Operation with the PC software RMGView<sup>RSM</sup>

There is an opening on the housing cover (see *Figure 15: Display*) for communication via the IR head. The IR head is placed on this window and then fixed magnetically. The other side of this communication is plugged into a USB interface (serial interface) of the PC. The interface type is an IEC-1107 interface; further communication details can be found in *chapter 6.8.8 Communication*.

### Note

**The opening of the IR head is protected from scratches by a protective film, protective paper, and an iron ring. This complete protection must be removed for operation.**

**Communication via the infrared interface only works if the optical head is centered over the round mount. In addition, the labeling of the IR head must have the same orientation as the display (the cable must continue downward).**

The optical interface is activated via a magnet (reed contact) and remains active as long as the IR measuring head is applied and the connection to the PC is established. The simultaneous display goes out after 60 s. The IR interface is used:

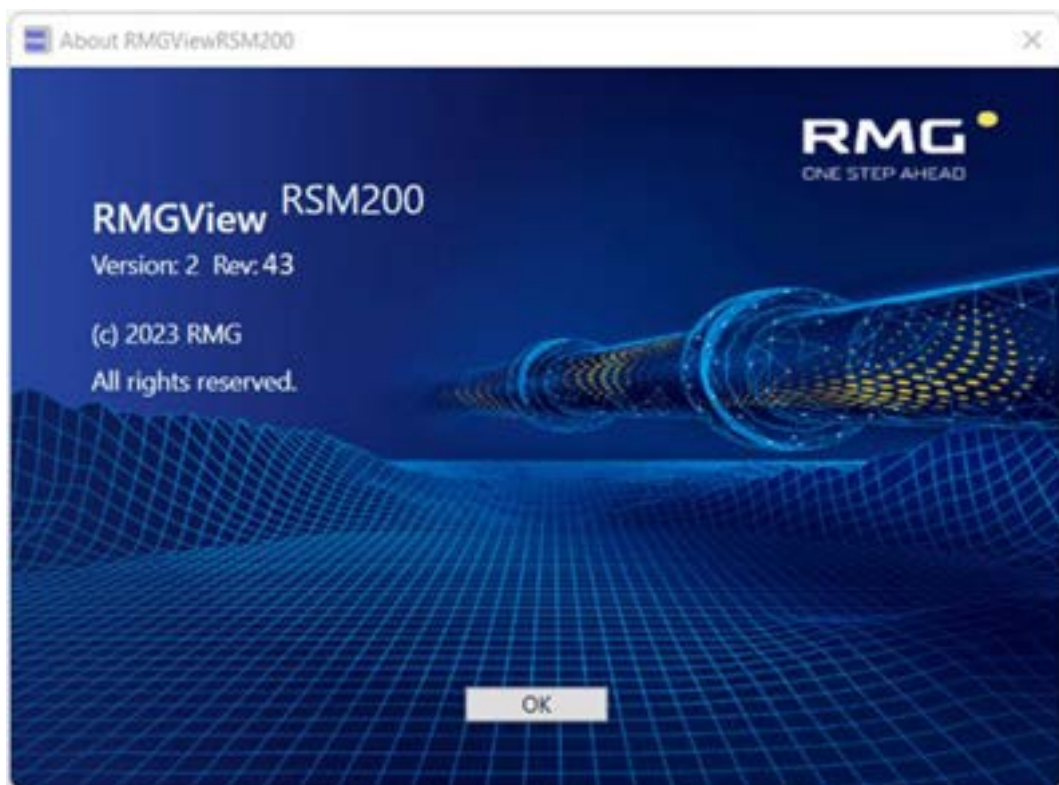
- For local serial communication (Modbus) with RMGView<sup>RSM</sup> (diagnostic tool and parameterization interface)
- Data download (via RMGView<sup>RSM</sup>)
- Enables firmware update and firmware download with open calibration switch. (via RMGView<sup>RSM</sup>)



**Figure 20: IR data communication**

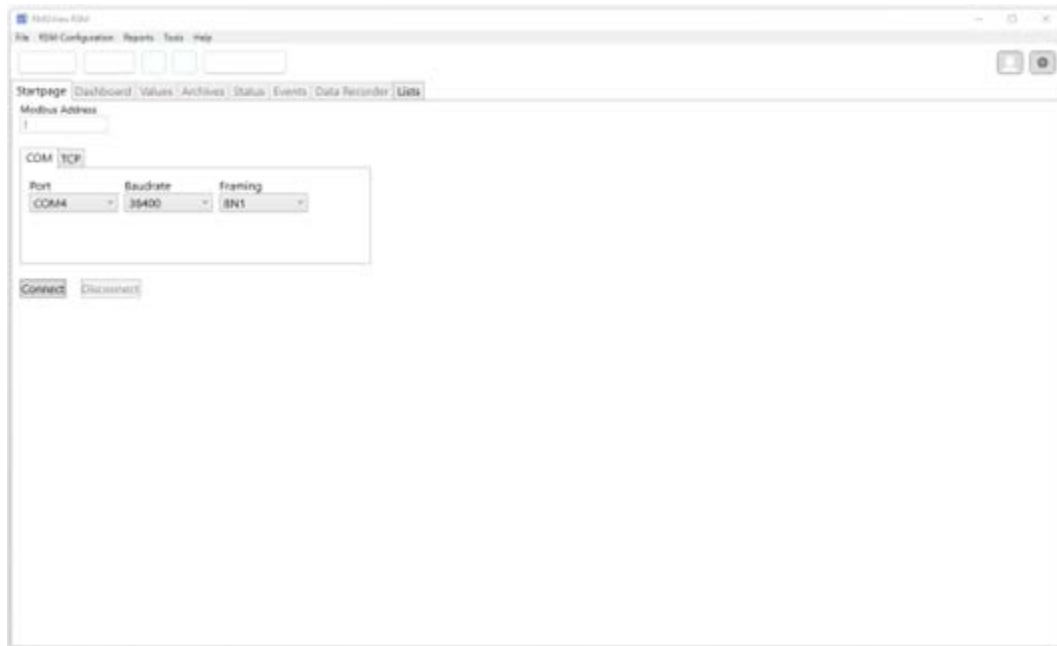
The use of the RMGView<sup>RSM</sup> offers - compared to the 5 keys of the RSM 200 - a very comfortable way to operate the RSM 200. The settings are at least equivalent, the highest operating level, expert or service mode, is only possible via the RMGView<sup>RSM</sup>. Because of the higher comfort, the RSM 200 is (probably) mainly operated via the RMGView<sup>RSM</sup>. The exclusive operation via keys and display is nevertheless possible.

After the activation of RMGView<sup>RSM</sup> it appears




**Figure 21: RMGView<sup>RSM</sup>**

and the work screen of the software



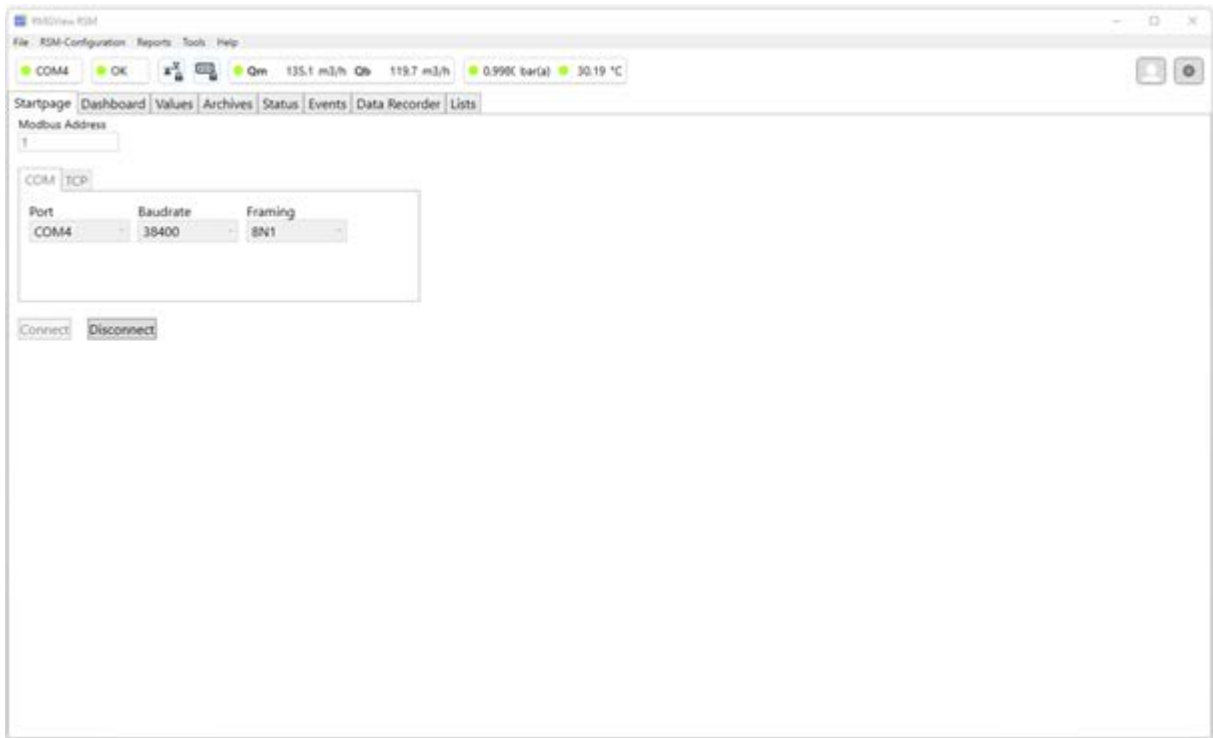
**Figure 22: Start screen RMGView<sup>RSM</sup>**

Before activating further actions, select the language by clicking Settings . It appears:




**Figure 23: Language selection in RMGView<sup>RSM</sup>**

You can choose between DE (German) and EN (English) You have to close this field after your choice of language by clicking the X in the upper right corner. If you have selected the correct USM port (here COM 4) for your Modbus connection via infrared head, you can start with the further settings: Modbus address: 1, baud rate: 38400 and framing: 8N1 starting a connection. A work screen appears:



**Figure 24: Work screen of RMGView<sup>RSM</sup>**

The tabs in the top line indicate a correct functioning operating state of the RSM 200 with green circles.

To get the access rights as configurator , you need to change the access in the software from "Monitor" to "Configurator" with the password: „RMGRSM-C“. Close also this field after your setting by clicking the X in the upper right corner.



**Figure 25: Access rights in RMGView<sup>RSM</sup>**

You can then set the codeword via the RSM 200 or (more conveniently) via the RMGView<sup>RSM</sup> software. This is equivalent!

## In RSM 200

Main display **D** Parameters **V** and **D** Settings **D** Codeword enable; Entering and confirming the codeword as described (see below *chapters 6.6.1 Setting with the operating keys* and *6.7.1 Programming with the programming buttons*). The display shows the codeword **123** and an open lock **G** to the left of the battery indicator.

72

## In RMGView<sup>RSM</sup>

To do this, go to the "Values" tab, then down to "Z: Settings", click on "Z15 Codeword enable" in the menu that opens and then enter the codeword "1 2 3 4" as the value. You can recognize the activated codeword by the icons under the menu bar; the lock in the codeword field **\*\*\*** turns red and is open.

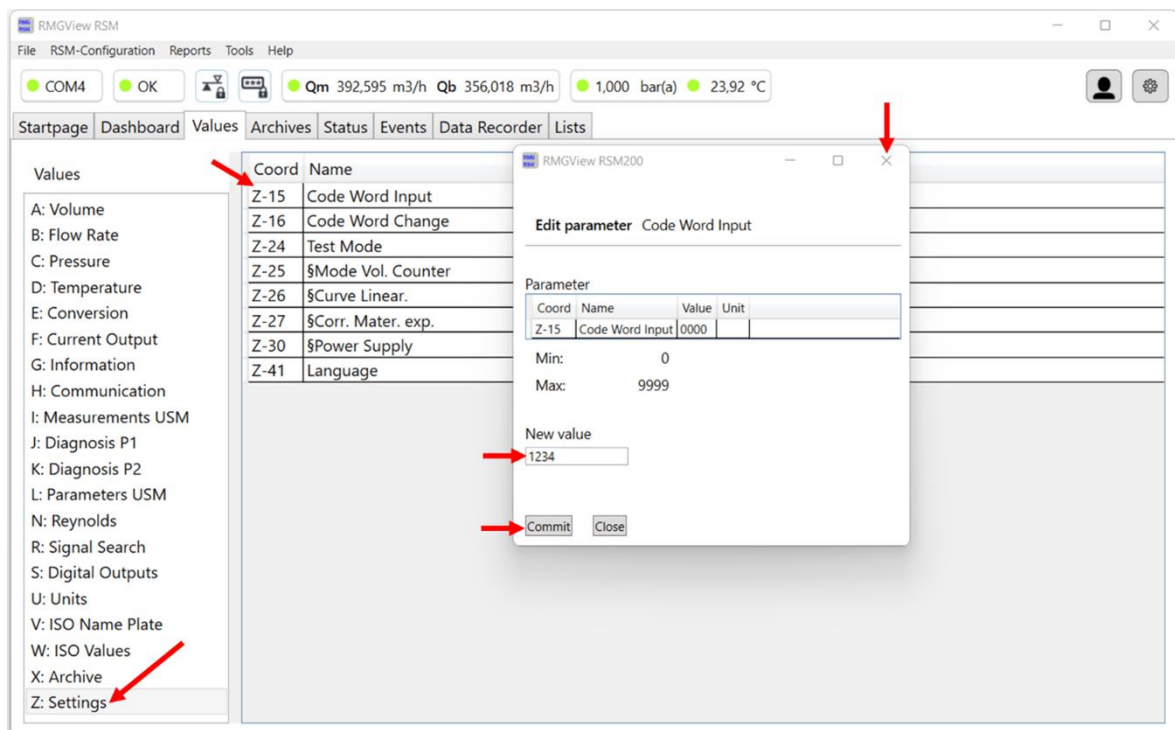





Figure 26: Entering the codeword in RMGView<sup>RSM</sup>



Figure 27: Codeword access rights in RMGView<sup>RSM</sup>

In order to be able to change parameters relevant for calibration, the calibration button must be pressed, too; the RMGView<sup>RSM</sup> software detects this. You then have the **same access rights and setting options on the RSM 200 directly or indirectly via the RMGView<sup>RSM</sup> software**. You can recognize the activated calibration switch in



the display of the RSM 200 to the left of the battery symbol by the calibration key  and an open lock . In the RMGView<sup>RSM</sup> software, the lock in the calibration button field  turns red and is open.



**Figure 28: Calibration button access rights in RMGView<sup>RSM</sup>**

**⚠ Caution**

**It is necessary to remove the seals, particularly the seal over the calibration button in order to press the calibration button (see *Figure 16: Position of the calibration switch*).**

**The RSM 200 must only be used for custody transfer with unbroken seal. Removal or damage to seals normally entails considerable expenses!**

**The re-fitting of seals may only be carried out by an officially authority or a custody transfer office!**

The codeword release and the opened calibration switch are reset to "closed" after 60 minutes. This is to prevent a "forgotten close" from allowing unauthorized access to device parameters.

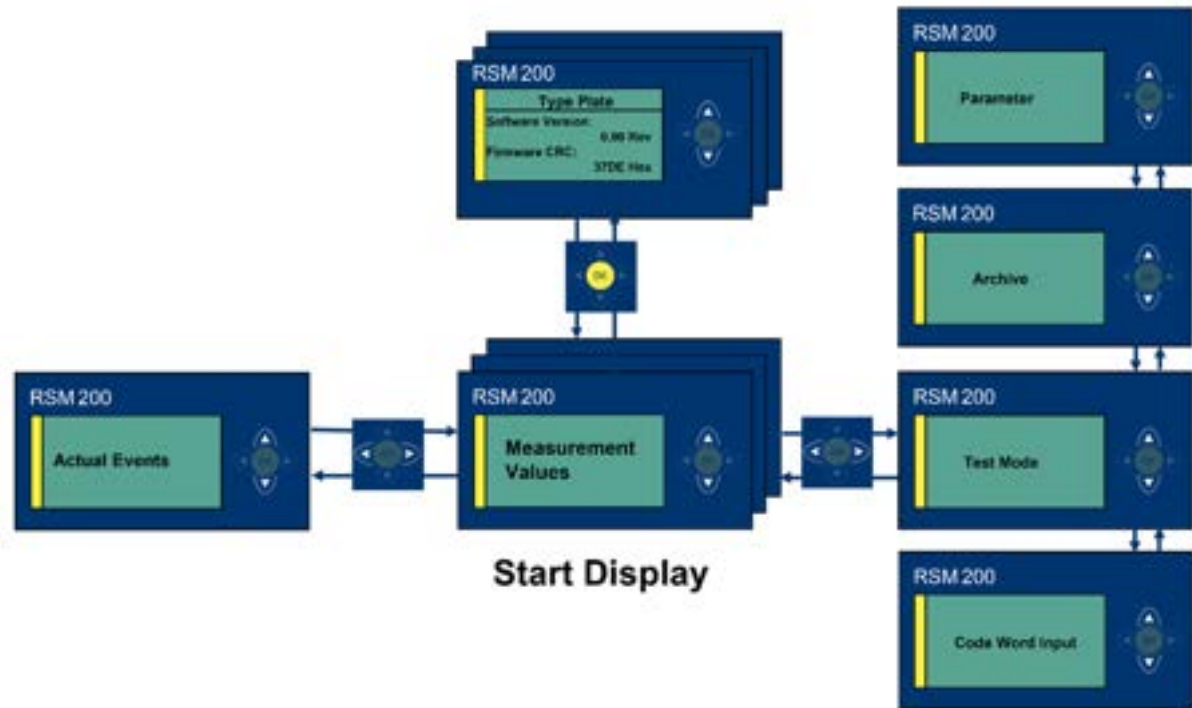
Further handling in the Software RMGView<sup>RSM</sup> software is simple, just go to the "Value" field of the corresponding coordinate, which are further explained below, and change them if necessary and with the appropriate access authorization.

**Note**

**Changes via RMGView<sup>RSM</sup> software or directly via the RSM 200 keys are equivalent. Operation via RMGView<sup>RSM</sup> is simpler and clearer.**

In *chapter 6.7.1 Programming with the programming buttons* the operation via the 5 keys and the display of the RSM 200 is explained.

## 6.6. Menus and display structure



**Figure 29: Display settings and operation**

The display navigation consists of several levels, which can be changed via the control panel. After the device start, the main or start display with the display of the measured values is active. If the display is changed by the user, the device jumps back to the start display after 1 minute.

From the start display - in the center of *Figure 29: Display settings and operation* you can reach the other display menus with the operating keys.






### 6.6.1. Setting with the operating keys

By means of the cursor keys (arrows), you can change the display and make various settings with a light press on the desired key.

Occasionally, a cursor key may need to be pressed 2 times to execute a command.



**Figure 30: Operating keys (cursor)**

Key-board	Name	Effect
	Left arrow	<ul style="list-style-type: none"> <li>• Switches to the "Upcoming Events" display from the start display.</li> <li>• Switches to the measured value display from the main menu display.</li> <li>• Switches to a higher menu level in the menus (parameters, archives, test mode or codeword enable [PAPC]).</li> <li>• Changes the position of the cursor to the left.</li> </ul>
	Right arrow	<ul style="list-style-type: none"> <li>• Switches back to the measured value display from the "Upcoming Events" display.</li> <li>• Switches to the display of the main menus (PAPC) from the measured value display.</li> <li>• Switches to a menu level lower in the menus (PAPC).</li> <li>• Changes the position of the cursor to the right.</li> </ul>
	Up arrow	<ul style="list-style-type: none"> <li>• Switches between menu items.</li> <li>• Switches the displayed values of the measured value display.</li> <li>• Used to scroll values (e.g. display measured value archive or type plate).</li> <li>• Character or function selection at the cursor position.</li> </ul>
	Down arrow	<ul style="list-style-type: none"> <li>• Switches between menu items.</li> <li>• Switches the displayed measured values.</li> <li>• Used to scroll values (e.g. display measured value archive or type plate).</li> <li>• Character or function selection at the cursor position.</li> </ul>
	Confirmation	<ul style="list-style-type: none"> <li>• Switches to a menu level lower in the menus (PAPC).</li> <li>• Display of the electronic type plate of the measured value display.</li> <li>• Change to the measured value display from the nameplate.</li> <li>• Confirming and exiting the edit mode</li> </ul>

75

---



---



---

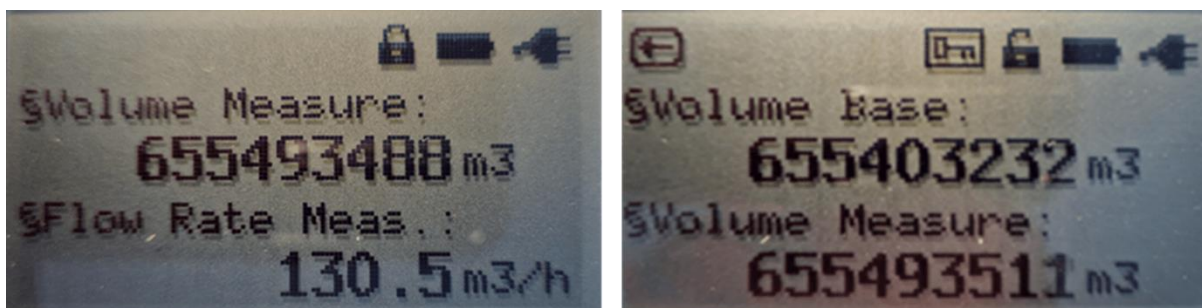


---

**Table 8**

### 6.6.2. Main/start display

Two values are displayed simultaneously in the start display.



**Figure 31: Main/start display (without / with quantity transformer)**

The other values can be selected via the operating keys (top, bottom). Depending on the device type, the displayed values differ.

### Display without quantity converter



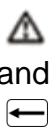



- Measurement volume
- Measurement flow rate
- Gas speed VoG
- Sound speed SoS
- Time
- Date



### Display with quantity converter

- Standard volume
- Measurement volume
- Standard volume error
- Measurement volume error
- Standard flow rate
- Measurement flow rate
- Pressure
- Temperature
- Real gas factor
- K number
- Gas speed VoG
- Sound speed SoS
- Time
- Date

### 6.6.3. Status display


Additionally, the status is displayed, as indicators there are the following symbols:

Symbol	Meaning	Description
	External power supply	Displayed when the RSM 200 is supplied with external power.
	Battery level Battery	Battery operation; fully charged here, 100% is then displayed for pure battery operation.
	Warning, error, note, Error blinks	There is a fault: A fault, a warning or a note Activation of key  "to the left" => event menu with further information about the fault (status, error, ..)
	Calibration switch closed	Metrological parameters are protected against changes
	Calibration switch open	Metrological parameters can be changed

	Codeword set	Numerical code word was entered correctly. Non-metrological parameters can be changed.
	Calibration switch and codeword	Metrological parameters can be changed.

**Table 9**

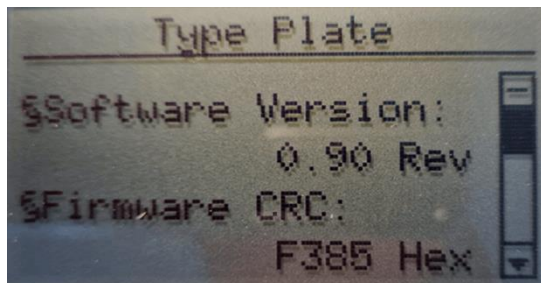
**Note**

If the status "Error", "Warning" or "Note" takes place, then the symbol  appears in left upper corner.

In battery mode, the filling level of the battery is displayed as a percentage next to the battery symbol. This corresponds to the value in the coordinate **G24 Remaining Batt. Cap.**

### 6.6.4. Electronic type plate

The display of the electronic type plate shows two values at a time.



**Figure 32: Type plate**

The other values can be selected and displayed via the operating keys (up, down).

**Display without quantity transformer**

- Software version
- Firmware CRC
- Serial number
- Measuring point
- Electronic serial number

**Display with quantity transformer**

- Software version
- Firmware CRC
- Serial number
- Measuring point
- Electronic serial number
- Pressure sensor serial number

- Pressure range minimum (sensor values)
- Pressure range maximum (sensor values)
- Standard pressure
- Temperature sensor serial number
- Temperature range minimum (sensor values)
- Temperature range maximum (sensor values)
- Standard temperature

### 6.6.5. Events

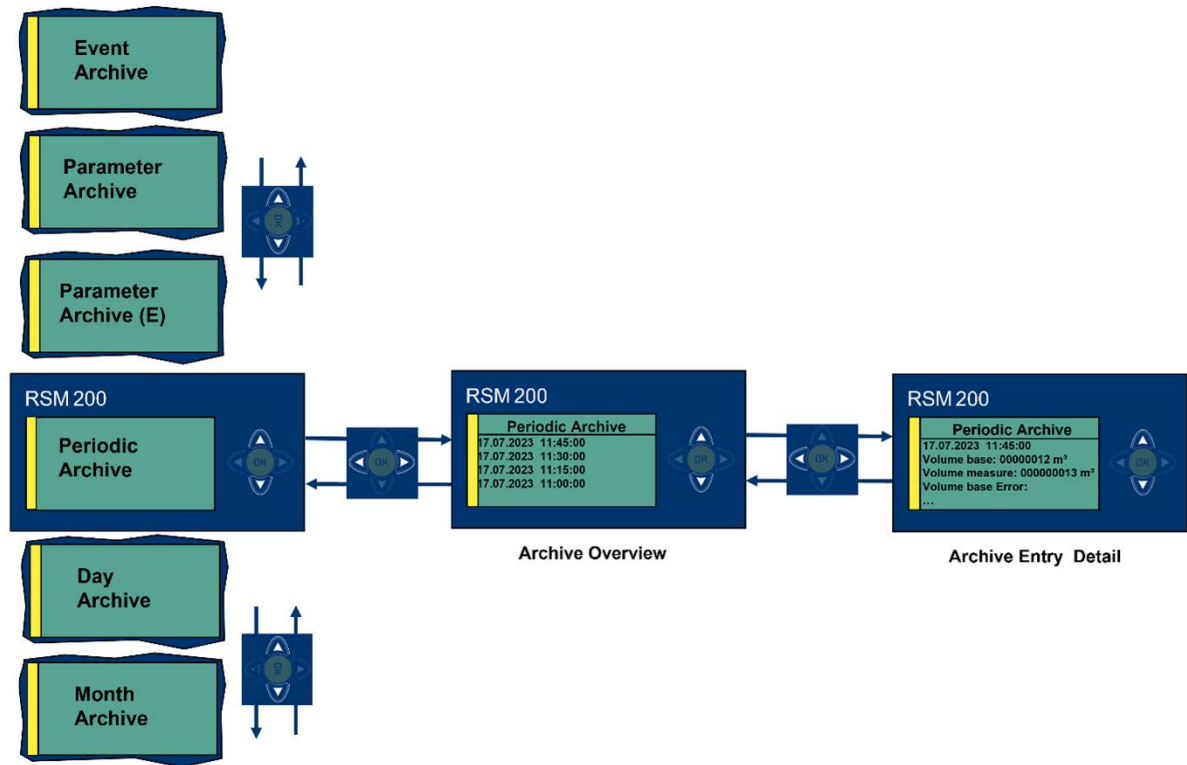
Events, error messages, warnings and hints are listed in *chapter 8 Event messages*.

### 6.6.6. Display of test mode

The test mode is described in *chapter 6.3 Test mode*.

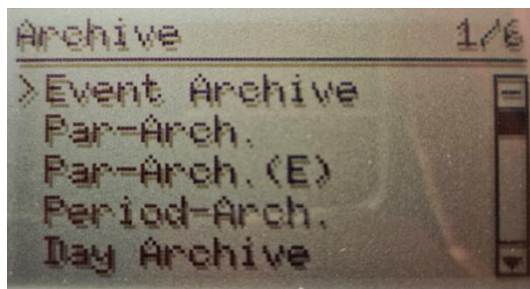
### 6.6.7. Archive

The different archives can be read out and the content can be shown on the display. The next figure shows how to get from the archive overview to the detailed view or to the individual archives using the operating keys. There is an event archive, a parameter archive, custody transfer (E) and non-custody transfer, a period archive, a daily archive and a monthly archive.



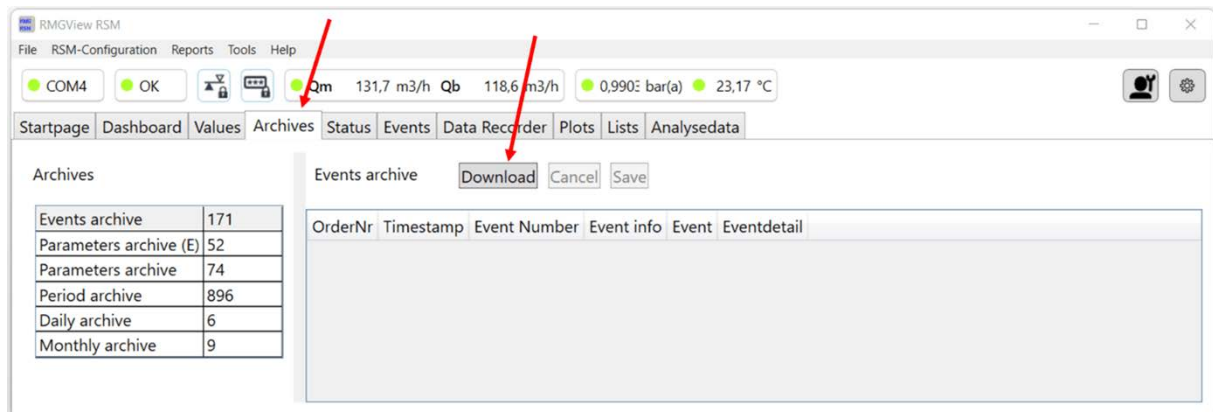
**Figure 33: Archive**

The next figure shows the selection of the different archives.



**Figure 34: Display: Archive selection**

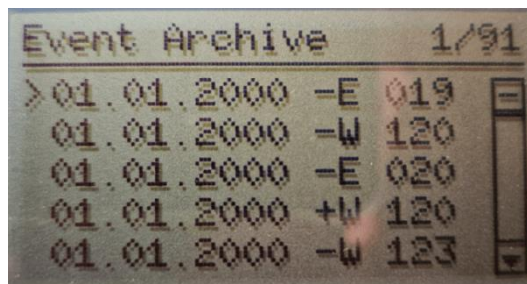
In RMGView<sup>RSM</sup>, you can access the respective archives via the "Archives" tab.



**Figure 35: Archives via RMGView<sup>RSM</sup>**

By downloading, the contents of the individual archives can be accessed and inspected. This and the downloading of the data will be shown in the next chapters.

#### 6.6.7.1. Event archive



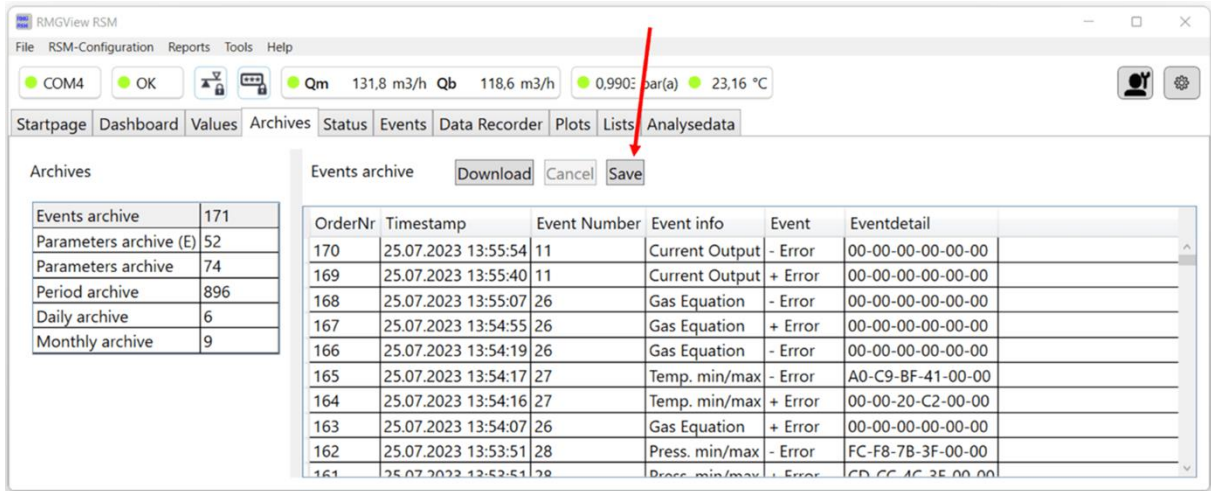
**Figure 36: Display: Event archive**

Using the operating keys, each event can be selected – the top one is selected in the figure – and the content is shown in the display. The following content is displayed in each case, which is also stored:

- Order number
- Time (date, time)
- Event type  
(Error / Warning / Note, + coming / - going;  
coming [going] events are represented with + [-] followed by the first letter of the type Error / Warning / Note [E / W / N])
- Event number (event text)
- Event data (additional values)
- CRC16



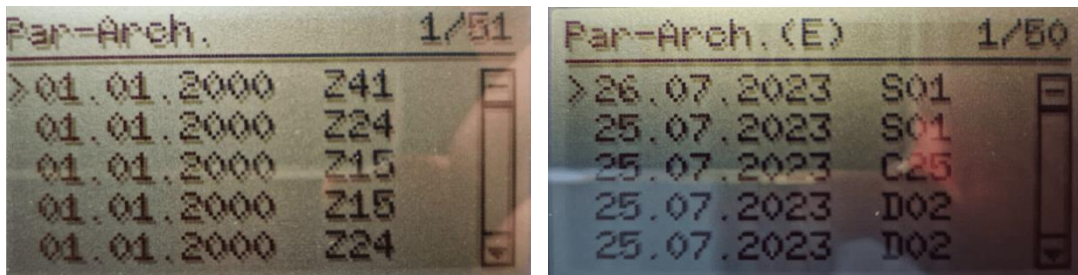
The content can be displayed more smartly via the RMGView<sup>RSM</sup>; after downloading it shows:



**Figure 37: Event archive via RMGView<sup>RSM</sup>**

Here, the content of the individual events is already clearly listed, i.e. whether it is a warning, a note or an error and what the reason for the event was. If required, the archive can be saved as an Excel-readable `***.csv` file. The desired file name and folder can be freely selected.

**6.6.7.2. Parameter archive**



**Figure 38: Display: Parameter archive**

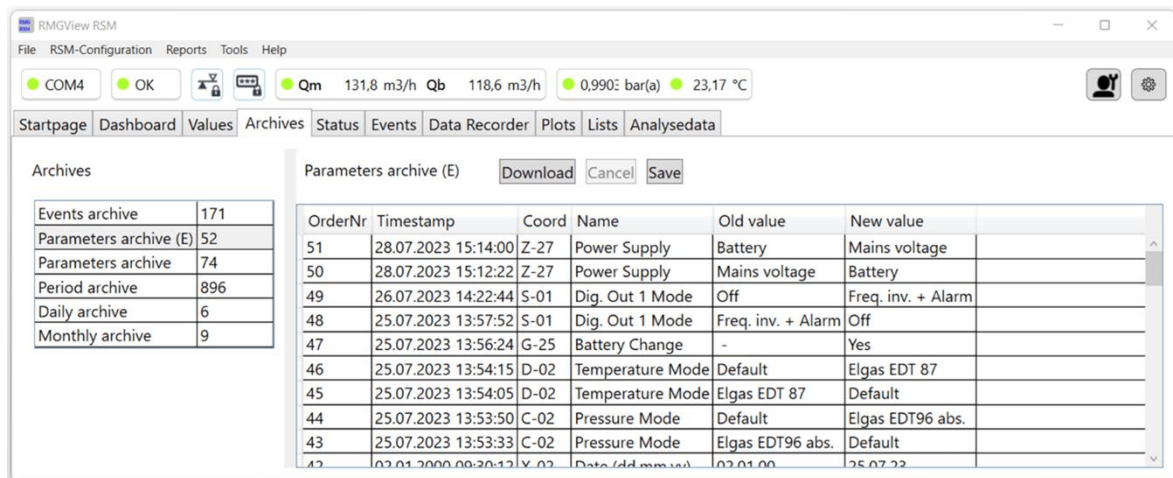
The operating keys can also be used to select any entry in the parameter archive or, in the case of the RSM 200 VC / VCF, in the custody transfer parameter archive – the topmost is selected in each case in the illustration – and the contents are shown in the display. The following content is displayed in each case, which is also stored:

- Order number
- Time (date, hour)

- Coordinate (for example **A01 standard volume**)
- Old parameter value
- New parameter value
- CRC16

82

Again, the content can be downloaded with RMGView<sup>RSM</sup> and saved as an Excel-readable **\*\*\*.csv** file.



The screenshot shows the RMGView RSM software interface. The 'Archives' tab is active, displaying a table of parameter changes. The table has columns for OrderNr, Timestamp, Coord, Name, Old value, and New value. Below is the data from the table:

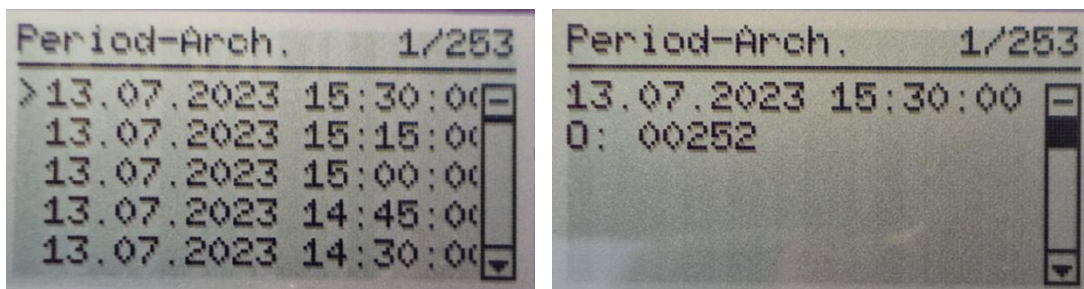
OrderNr	Timestamp	Coord	Name	Old value	New value
51	28.07.2023 15:14:00	Z-27	Power Supply	Battery	Mains voltage
50	28.07.2023 15:12:22	Z-27	Power Supply	Mains voltage	Battery
49	26.07.2023 14:22:44	S-01	Dig. Out 1 Mode	Off	Freq. inv. + Alarm
48	25.07.2023 13:57:52	S-01	Dig. Out 1 Mode	Freq. inv. + Alarm	Off
47	25.07.2023 13:56:24	G-25	Battery Change	-	Yes
46	25.07.2023 13:54:15	D-02	Temperature Mode	Default	Elgas EDT 87
45	25.07.2023 13:54:05	D-02	Temperature Mode	Elgas EDT 87	Default
44	25.07.2023 13:53:50	C-02	Pressure Mode	Default	Elgas EDT96 abs.
43	25.07.2023 13:53:33	C-02	Pressure Mode	Elgas EDT96 abs.	Default

**Figure 39: Parameter archive via RMGView<sup>RSM</sup>**

You can clearly see the above content and how the (here custody transfer) parameters have been changed.

### 6.6.7.3. Periodical, daily and monthly archive

These archives are displayed only if they are enabled in the parameters. Here, too, the operating keys are used to access the entries (left figure), the contents of which can be shown in the display (right figure).



The left screenshot shows a handheld device display with the title 'Period-Arch.' and '1/253'. The display shows a list of timestamps:

```

>13.07.2023 15:30:00
13.07.2023 15:15:00
13.07.2023 15:00:00
13.07.2023 14:45:00
13.07.2023 14:30:00

```

The right screenshot shows the same handheld device display with the title 'Period-Arch.' and '1/253'. The display shows the selected entry:

```

13.07.2023 15:30:00
0: 00252

```

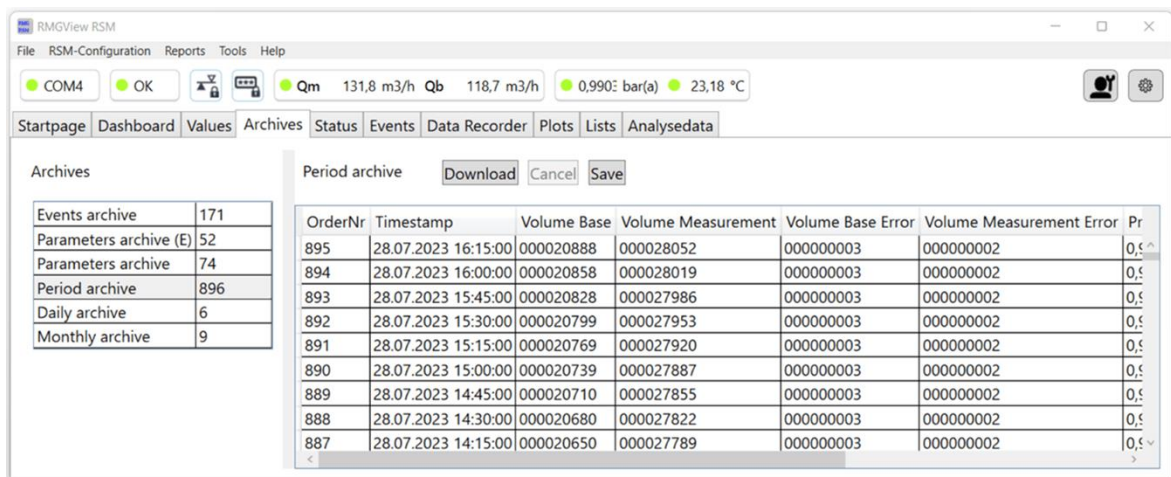
**Figure 40: Display: Periodical archive**

Meter readings and average values of important measured variables are periodically stored in the measured value archives. By scrolling down (on the right figure), the meter readings and average values of the most important measured variables - as shown below - are displayed:

- Order number
- Time (date, hour)
- Standard volume
- Measurement volume
- Standard volume error
- Measurement volume error
- Average pressure
- Average temperature
- Average compressibility
- Status (0 = all average values ok  
1 = at least one average value is faulty)
- CRC16

Scrolling between entries is possible in the general view. Due to the high amount of stored content, the detail view is spread over 5 pages. Switching between pages is done using the control keys (top, bottom).


Here, too, RMGViewRSM offers a convenient display and down-load of the values.

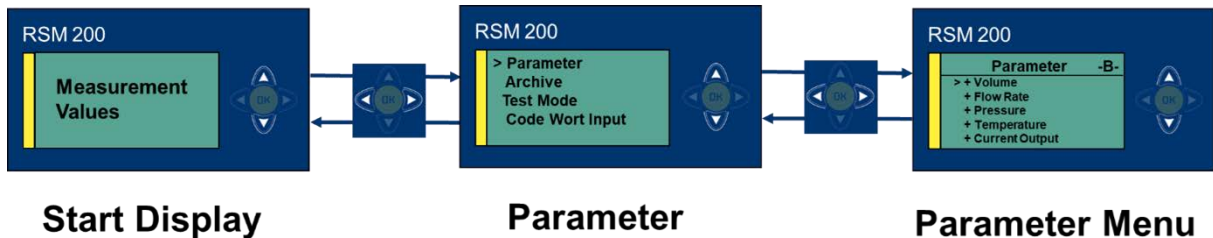


**Figure 41: Periodical archive via RMGView<sup>RSM</sup>**



The period or daily archive is structured similarly to the period archive and can be handled in the same way with the display functions or the operating keys as well as with RMGViewRSM.

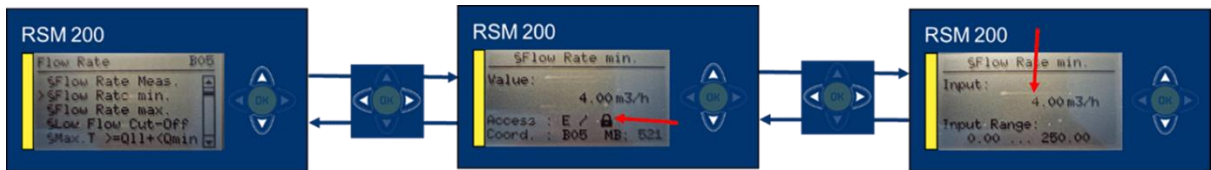
### 6.6.8. Parameters

All configuration data measured and calculated values can be selected via the Parameter menu. The parameter menus are described in more detail from *chapter 6.8. Coordinates in context*. The parameter menu is accessed with the operating key .





**Figure 42: Parameters**

Pressing the operating key  takes you to the flow menu, for example, which is indicated by ">". Pressing again  shows the different parameters in this menu.



**Figure 43: Change of parameters**

By  you get to the coordinate **B05 Flow min.**, the minimum flow  $Q_{\min}$  (see *chapter 3.4 Measuring ranges and precision*). (Only) When the calibration lock is open, the flashing value can be changed by pressing . The change of parameters is described in *chapter 6.7.1 Programming with the programming buttons*.

In the middle picture, in addition to the coordinate name and address, you can see the parameter protection, custody transfer "E", whether the calibration lock is closed / open and the Modbus address: "MB: 521". The right picture shows the possible setting range for the selected parameter: 0.00 ... 250.00 m<sup>3</sup>/h.

It is more comfortable to change parameters with the help of RMGView<sup>RSM</sup>. In RMGView<sup>RSM</sup>, you can access the parameter values and settings via the "Values" tab.

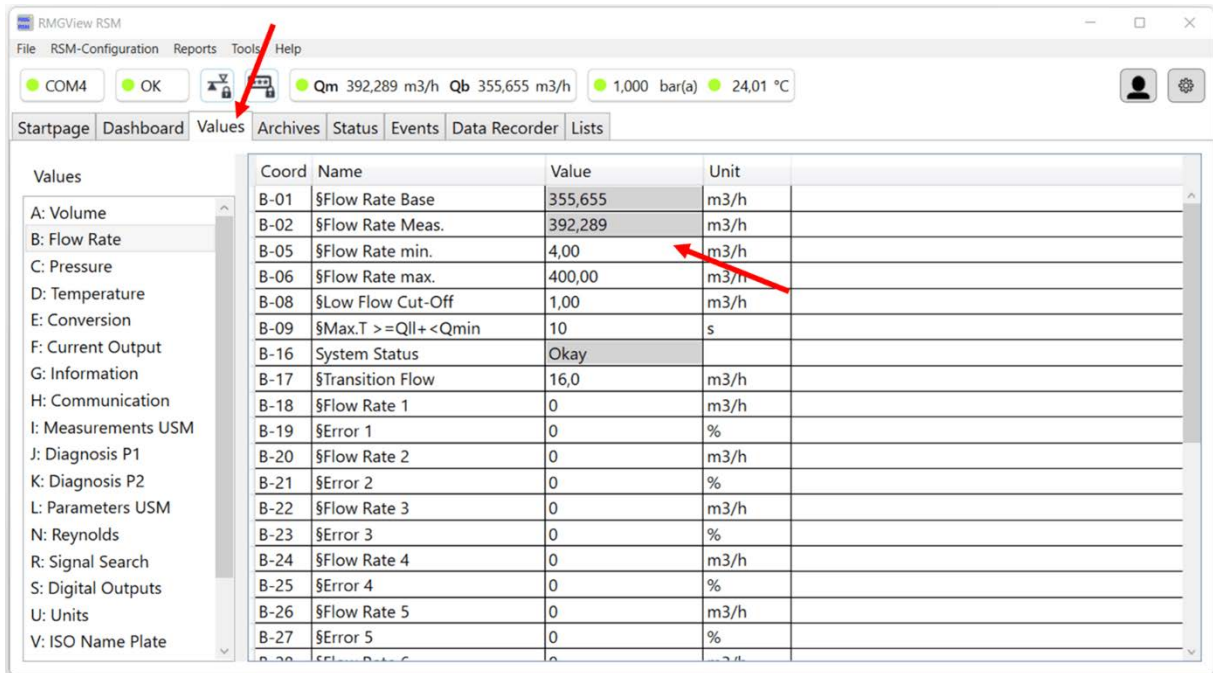


Figure 44: Parameter access via RMGView<sup>RSM</sup>

Changing parameters in RMGView<sup>RSM</sup> is easy if access authorization is given (see chapter 6.6.9 Access protection); click on the desired field under Value (here B05 Flow min.) and get:

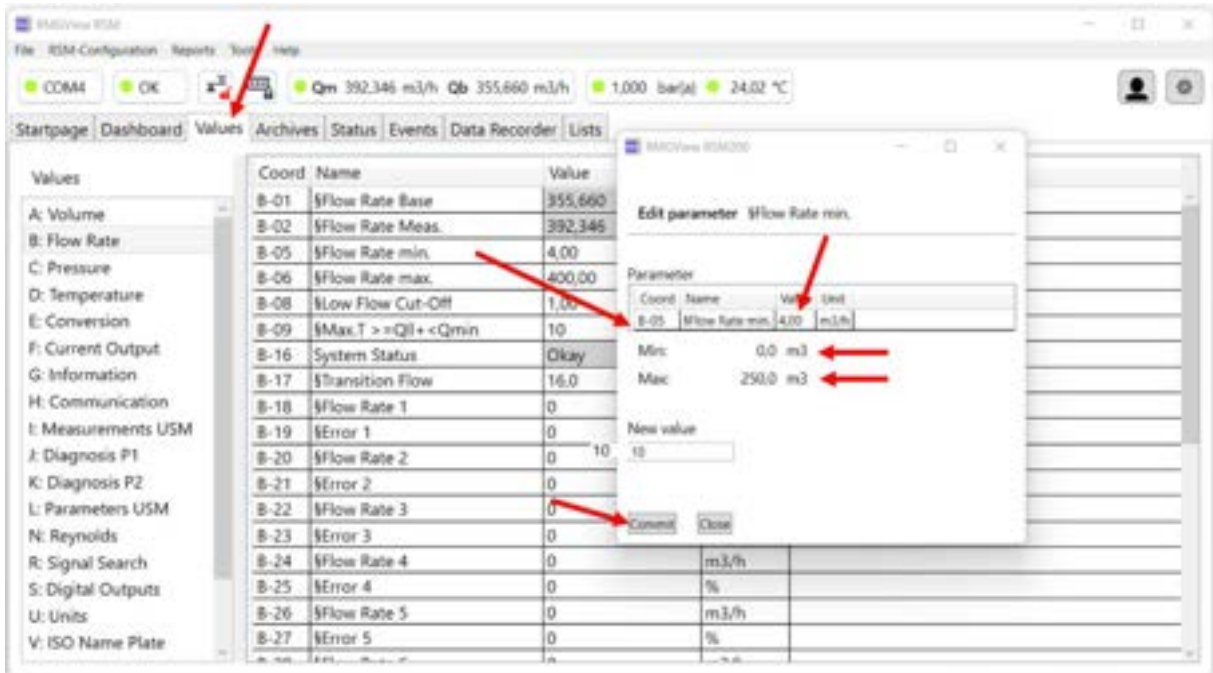


Figure 45: Change of parameters via RMGView<sup>RSM</sup>

As shown in the previous figure by the red arrow, the minimum flow rate is to be changed from 4 m<sup>3</sup>/h to a new value. This value is to be entered in the field under "New value"; above it you can see the possible setting range; here from 0.0 m<sup>3</sup>/h to 250.0 m<sup>3</sup>/h. With "Commit", the field becomes dark grey – accessible – the new value is entered into the field B05.

### Note

The standard register addresses of the F instance defined in accordance with DSfG can be viewed in the "Values" tab under "V: ISO nameplate" and "W: ISO values" but cannot be changed.

## 6.6.9. Access protection

Access to all parameters is divided into 4 categories. You can read this access authorization in the display, for example, when you have selected the respective parameter.

### Access A

The parameters covered by this access are pure display values. They cannot be changed.

### Access N

All parameters with the access N can be changed without further authorization in the predefined setting range.

### Access C

By entering the access code (" 1 2 3 4 ") changes of these parameters are possible. All these parameters are important and relevant but are not to be metrologically protected. The changes are registered with the time of the change and the old and new value in the non-metrological parameter logbook and displayed in the event display. The change is written to the end of the logbook, if the logbook is full, then the first entries are overwritten, so that always the last 300 entries are documented.

### Access E

All custody transfer parameters, i.e., metrologically relevant parameters, are protected by the (sealed) calibration switch. To change these metrologically relevant parameters, the calibration switch must be pressed, i.e., the calibration lock is open. Opening the calibration lock also releases all non-metrologically relevant parameters that are protected by the access code.

The changes are registered in the custody transfer parameter logbook with the time of the change and the old and new values and are displayed in the event display. The change is written to the end of the logbook, if the logbook is full, then no further entries are documented.

When the calibration switch is open, the archives can also be reset.

87

The code word release and the opened calibration switch are reset to "closed" after 60 minutes. This is to prevent "forgotten closing" from allowing unauthorized access to device parameters.

All custody transfer parameters are marked by a preceding paragraph sign "§" in the RSM 200 and in the RMGView<sup>RSM</sup>.

## 6.7. Programming

There are five buttons available on the front foil for programming of the RSM 200. This programming is explained first: Alternatively, you can easily carry out programming via the RMGView<sup>RSM</sup> operating software whose use is explained in *chapter 6.5 Operation with the PC software RMGViewRSM*.

Then, before explaining how to handle the parameters, there is a brief description of the common formula symbols and equations defining them.

### 6.7.1. Programming with the programming buttons

Basically, you proceed as follows for the programming:

- First check the protection status of the coordinate. When parameters are not protected, you can carry out changes, as described below without additional measures.
- With parameters protected by code word, you must enter it first in coordinate Z15. How to get there, please read in *chapter 6.8. Coordinates in context*. Please read how to make the entry as below.
- For custody transfer parameters, you must also press the calibration button.

### Caution













It is necessary to remove the seals, particularly the seal over the calibration button in order to press the calibration button (see *Figure 16: Position of the calibration switch*).

The RSM 200 may only be used for custody transfer purposes with an unbroken seal. Removal or damage to seals normally entails considerable expenses!


The re-fitting of seals may only be carried out by an officially authority or a custody transfer office!

88

The principle of the programming is shown based on the example of changing the output pulse factor (**coordinates S05 pulse factor LF**):

- I. Move with the arrows () to the position:  
**S05 pulse factor LF**
- II. Activate the calibration switch
- III. The display shows the desired parameter, its current value, the access, the coordinate and the Modbus register.
- IV. Press briefly 
- V. The value setting range starts to blink, the possible input range is displayed underneath
- VI. With the  and  arrows you can now increase or decrease the value at this position of the cursor. For the values you have besides "0", "+", "-", "." (= comma) and "E" (= exponent to base 10) available to enter the value.
- VII. With the  and  arrows, you can move to a different position of the value and change it – as described in the point above.
- VIII. An additional position is added when you move with the  and  before the displayed number.  
For example, only the units digit is displayed. If you move in front of it, you will also have the tens position available as an entry.
- IX. When you have finished making an entry, you confirm it by briefly pressing .
- X. A plausibility check takes place and the result is displayed immediately.
- XI. If this check shows an implausible entry, the display briefly shows "Out of min/max" and then "Parameter unchanged" and the display jumps back to the original value.
- XII. If this check shows an plausible entry, "parameter" will be shown briefly in the display and the value is adopted as a new value.



- XIII. Now you can – if necessary – change other parameters.
- XIV. By pressing the key  several times, the display returns to the display of the main totalizer.
- XV. By entering a (random) "wrong" code word, you terminate the possibility of further input of parameters subject to custody transfer. In addition to resetting the code word, the calibration lock is also closed.

**Note**

**Some of the coordinates permit other settings as purely numerical values. However, these other entries are assigned numbers so that the adjustment can be – carried out – as described.**

**Example:**

At the interface settings (**H Communication**) different settings of the **H03 onboard protocol** can be activated:

0	Off
1	Modbus RTU (default setting)
2	Modbus ASCII

If for the **coordinate H03** = "0" is selected, then the Modbus protocol is switched off.

With RMGView<sup>RSM</sup> the setting proceeds as described above in *chapter 6.6.8 Parameters for minimum flow*.

**6.7.2. Equations in the RSM 200**

The RSM 200 enables calculation of different values from the measured data. For a better understanding, some variables and formulae in this chapter are presented in advance; other equations and definitions of parameters are found in the *chapter 6.8. Coordinates in context*.

### 6.7.3. Variable description

Formula symbol	Units	Name
$Q_m$	m <sup>3</sup> /h	Volume flow rate at measurement conditions
$K_V$	l/m <sup>3</sup>	Counter factor (pulse value)
$V_b$	m <sup>3</sup>	(accumulated) Volume at measurement (base) conditions
$Q_b$	m <sup>3</sup> /h	Volume flow rate at standard (base) conditions
$V_b$	m <sup>3</sup>	(accumulated) Volume at standard conditions
$Z_u(p, T)$	Non-dimensional	Real gas factor
$p$	bar(a), psi(a)	Measured pressure (absolute) The pressure refers to the vacuum; thus, the pressure under "normal conditions" is 1.01325 bar(a). This designation is common in Europe; therefore, the (a) is often omitted.
$p$	bar(rel), psi(g)	Measured pressure (relative) The pressure is specified relative to the currently prevailing ambient pressure. Under "normal conditions" the pressure is then 0.0 bar(rel). In North America, the print type (a or g) is always specified.
$p_b$	bar(a), bar(g)	Pressure at standard (base) conditions =1.01325 bar absolute)
$T$	°C	Measuring temperature
$T_K$	°K	Measuring temperature in Kelvin
$T_b$	°K	Temperature at standard conditions (= 273.15 K)
$K$	Non-dimensional	K number
$Z$	Non-dimensional	Real gas factor
$Z_b$	Non-dimensional	Real gas factor at standard (base) conditions (calculation for $Z$ and $Z_n$ takes place according to GERG-88 in accordance with G9)

### 6.7.4. Standard formulae

Formula designation	Formula	Reference chapter
Compressibility coefficient	$C = \frac{Z}{Z_b}$	6.8.5 Conversion
Real gas factor	$Zu(p, T) = \frac{p \cdot T_b}{p_b \cdot T_K \cdot K}$	6.8.5 Conversion
Standard volume flow rate	$Q_b = Q_m \cdot Zu(p, T)$	6.8.2 Flow rate
Standard volume	$V_b = V_m \cdot Zu(p, T)$	6.8.1 <b>Volume / Volume / Counters</b>

Measuring and standard pressure are calculated as absolute pressure in the specified equations.

## 6.8. Coordinates in context

The following shows the coordinates that can be addressed with the RSM 200 flow rate meter, the parameters are shown in different colors in the tables.

92

The RSM 200 is offered in different versions, a pure volumetric flow rate meter, which only measures the measurement volumetric flow rate without pressure and temperature correction. These coordinates are shown in light blue. If this variant was selected, then the other green coordinates are not visible in the menu of the RSM 200, except for the default settings for the pressure and the temperature.

The other versions RSM 200 VC / VCF are with a volume correction, which requires pressure and temperature values for this. Constant (default) values can also be entered for these. All parameters required for the conversion and calculated from this are shown in light green.

	Type of instrument	Area of application
Volume at measurement conditions	RSM 200 VM RSM 200 VMF	Non-custody transfer use custody transfer use
Volume At measurement and standard conditions With volume correction (only with pressure and temperature values)	RSM 200 VC RSM 200 VCF	Non-custody transfer use custody transfer use

### 6.8.1. Volume / Counters

Coordinate	Name	Description
A01	§Volume base	Volumes added up, corrected according to the equation above, plus the status and compression factor (see above).
A02	§Volume measure	Volumes added up at current (temperature and pressure) conditions.
A03	§Vol. base Err.	Volumes added up under standard conditions; in these conditions a parameter was faulty or could not be determined (e.g. temporary failure of the temperature sensor, etc.)
A04	§Vol. measure Err.	Volumes added up under the present conditions; in these conditions a parameter was faulty or could not be determined (e.g. flow rates below or above the flow rate range, etc.)
A05	§Volume Meas. Total	This is the sum of A02 and A04.
A20	§Resolution Exponent	<p>Setting range -3..3 Default: 0</p> <p>An exponent = 0 (default, fixed value) means that the integer number is equal to the counter value.</p> <p>A negative exponent increases the resolution and adds a decimal point in the display of the counter reading. The result is a decimal number in the volume unit cubic meter or cubic foot.</p> <p>A positive exponent reduces the resolution and inserts one or more zeros in the display of the counter reading on the right.</p> <div style="border: 1px solid black; padding: 5px; margin: 10px 0;"> <p><b>Note</b></p> <p><b>Changing the resolution of the exponent causes an entry in the event archive.</b></p> </div> <p>Further information on the counters can be found in <i>Annex A Counters</i></p>
A21	§Counter Digits	<p>The counter reading is stored in the device as an integer. The number of digits is set to 9 and cannot be changed.</p> <p>Further information on totalizers can be found in <i>Annex A Counters</i></p>

### 6.8.2. Flow rate

Coordinate	Name	Description
B01	§Flow rate base.	( $Q_b$ ) Flow rate value under standard conditions (see above)
B02	§Flow rate meas.	( $Q_m$ ) Flow rate value under current measurement conditions, with characteristic curve correction
B05	§Min. flow rate	( $Q_{m\ min}$ ) An alarm is generated below this flow rate

Coordinate	Name	Description
B06	§Max. flow rate	( $Q_{m \max}$ ) An alarm is generated above this flow rate
B07	§Max. value flow rate	Largest flow rate value recorded since the last valid measurement.
B08	§Low flow cut-off	Generally used to suppress undefined fluctuations of the flow at smallest values. Below this low flow cut-off, the flow is neglected, i.e. set to = 0 m <sup>3</sup> /h; this also applies if the low flow cut-off is set to 0 m <sup>3</sup> /h; no flow rate is calculated for small negative flow velocities.
B09	§Maximum time >= $Q_{m \text{ II}}$ + < $Q_{m \text{ min}}$	Indicates the maximum time until the flow rate (e.g., on start-up) reaches the measuring range ( $Q_{m \text{ min}}$ ) after reaching the low flow cut-off ( $Q_{m \text{ II}}$ ). This flow rate measurement is "strictly speaking" faulty, but no error message is generated within this time. In the total flow rate, this contribution is generally negligible.
B10, B11, B12, B13, B14,	§Coefficients: A-2, A-1, A0, A1, A2	<p>Z26: If the characteristic correction is deactivated, the additional parameters are not visible and cannot be adjusted. If a characteristic correction is activated (see Z26 below), a correction takes place with the factors in:</p> <p>B10: Factor for the characteristic correction <math>a_{-2}</math>            B11: Factor for the characteristic correction <math>a_{-1}</math>            B12: Factor for the characteristic correction <math>a_0</math>            B13: Factor for the characteristic correction <math>a_1</math>            B14: Factor for the characteristic correction <math>a_2</math></p> <p>These 5 coefficients are then part of a determination polynomial:</p> $Err(Q) = \frac{a_{-2}}{Q^2} + \frac{a_{-1}}{Q} + a_0 + a_1 \cdot Q + a_2 \cdot Q^2$ <p>The error determined with this polynomial, the deviation from the "actual" measured value, is usually subtracted from the measured value.</p> <p>More information can be found in <i>annex C Flow rate calibration</i>.</p>
B16	System status	Displays the status of the flow rate measurement of the RSM 200.
B17	§Transition flow rate	Transition from the smaller to the higher allowed measurement error.
B18, B20, B22, .. B40	§Flow rate 1, §flow rate 2, .. §flow rate 12	Set points for the set point correction [m <sup>3</sup> /h // cf/h].
B19, B21, B23, .. B41	§Error 1, §error 2, .. §error 12	Relative deviation [%] at the set point. Between the set points, the deviation is linearly approximated by a straight line. This deviation is subtracted from the measured value.
B42	§Alpha Material	Coefficient of expansion of the (inner) measuring cell material (currently aluminum)
B43	§T Calibration	Temperature value at which the above coefficient of expansion was determined.
B44	§Qmu-Factor Kv	Flow calibration factor; this value is used to apply the standard calibration (baseline) to the current meter.


### 6.8.3. Pressure

Coordinate	Name	Description
C01	§Pressure	Currently available pressure
C02	§Pressure mode	Pressure transmitter (source of the pressure measurement)
		0 Default (default, fixed value)
		1 EDT 96 (ELGAS) absolute (pressure compared to vacuum; common choice in Europe)
		2 EDT 96 (ELGAS) relative (pressure compared to ambient pressure)
C03	§Pressure default	Default value of the pressure
C04	§Minimum pressure	This value represents the minimum pressure value of the respective pressure transducer. An error is displayed if the pressure is below this limit. The permitted measuring range of the EDT sensor is shown in the Information menu; the limits specified here are set to these values by default.
C05	§Maximum pressure	This value represents the maximum pressure value of the respective pressure transducer. An error is displayed if the pressure is above this limit. The permitted measuring range of the EDT sensor is shown in the Information menu; the limits specified here are set to these values by default.
C08	§Pressure offset	With C08 and C09 the pressure sensor can be calibrated. The offset and the slope "shift" the output values of the pressure sensor accordingly. This calibration should only be carried out by a calibration officer if a more accurate pressure reference is available.
C09	§Pressure slope	
C13	§Atmospherically pressure	Pressure of the surrounding atmosphere. This value is required if a relative pressure sensor is used; this is generally only the case in North America.



### 6.8.4. Temperature

Coordinate	Name	Description
D01	§Temperature	Current temperature
D02	§Temperature mode	Temperature measurement transmitter (source of the temperature measurement)

Coordinate	Name	Description				
		<table border="1"> <tr> <td>0</td> <td>Specification (default, fixed value)</td> </tr> <tr> <td>1</td> <td>EDT 87 (ELGAS) (see <i>chapter 7.2.1 Temperature sensor</i>)</td> </tr> </table> 	0	Specification (default, fixed value)	1	EDT 87 (ELGAS) (see <i>chapter 7.2.1 Temperature sensor</i> )
0	Specification (default, fixed value)					
1	EDT 87 (ELGAS) (see <i>chapter 7.2.1 Temperature sensor</i> )					
D03	§Temperature default	Default value of the temperature				
D04	§Temperature minimum	This value represents the minimum temperature value of the temperature sensor at which the functionality of the RSM 200 is still guaranteed. An error is displayed if the temperature is below this limit. The permitted measuring range of the EDT sensor is shown in the Information menu; the limits specified here are set by default to the values within which the most relevant gas equations are valid (see below Menu E Conversion).				
D05	§Temperature maximum	This value represents the maximum temperature value of the temperature sensor at which the functionality of the RSM 200 is still guaranteed. An error is displayed if the temperature is above this limit. The permitted measuring range of the EDT sensor is shown in the Information menu; the limits specified here are set by default to the values within which the most relevant gas equations are valid (see below Menu E Conversion).				
D07	§Temperature offset	The offset "shifts" the output values of the temperature sensor. This calibration should only be performed by a calibration officer if a more accurate temperature reference is available.				

### 6.8.5. Conversion

Coordinate	Name	Description										
E01	§Conversion Factor	Real gas factor; see above										
E02	§Compr. Fac. ( $Z_m/Z_b$ )	Compressibility										
E03	§Compr. Fac, Meas. ( $Z_m$ )	real gas factor at measurement conditions										
E04	§Compr. Fac. Base ( $Z_b$ )	real gas factor at standard conditions										
E05	§Calculation method	<p>The RSM 200 enables calculation of gas parameters, particularly the compressibility coefficient according to various methods. These methods must be adjusted in <b>coordinate E05</b> with the corresponding coefficient. Available for selection:</p> <table border="1"> <tr> <td>0</td> <td>C coefficient constant (default)</td> </tr> <tr> <td>1</td> <td>Gerg 88 S</td> </tr> <tr> <td>2</td> <td>Gerg S-mod-H2</td> </tr> <tr> <td>3</td> <td>AGA8 GROSS method 1</td> </tr> <tr> <td>4</td> <td>AGA8 GROSS method 2</td> </tr> </table>	0	C coefficient constant (default)	1	Gerg 88 S	2	Gerg S-mod-H2	3	AGA8 GROSS method 1	4	AGA8 GROSS method 2
0	C coefficient constant (default)											
1	Gerg 88 S											
2	Gerg S-mod-H2											
3	AGA8 GROSS method 1											
4	AGA8 GROSS method 2											



Coordinate	Name	Description																												
		<table border="1"> <tr> <td>5</td> <td>AGA NX19-mod. (relative density)</td> </tr> <tr> <td>6</td> <td>AGA NX19-mod. (standard density)</td> </tr> <tr> <td>7</td> <td>GOST30319-2</td> </tr> </table>	5	AGA NX19-mod. (relative density)	6	AGA NX19-mod. (standard density)	7	GOST30319-2																						
5	AGA NX19-mod. (relative density)																													
6	AGA NX19-mod. (standard density)																													
7	GOST30319-2																													
		<p>The individual calculations are permissible for different pressure and temperature ranges. The pressure limits of all calculation methods are well above 20 bar, i.e. outside the application range of the RSM 200. Therefore, they do not need further consideration. The following ranges apply to the temperature:</p> <p>In pressure range up to 20 bar:</p> <table border="0"> <tr> <td>GERG88S</td> <td>-20°C to +65°C</td> </tr> <tr> <td>GERGS-mod-H2</td> <td>-20°C to +65°C</td> </tr> <tr> <td>AGA8 GROSS Meth. 1</td> <td>-10°C to +55°C</td> </tr> <tr> <td>AGA8 GROSS Meth. 2</td> <td>-10°C to +55°C</td> </tr> <tr> <td>AGA NX19-mod. (relative density)</td> <td>-10°C to +30°C</td> </tr> <tr> <td>AGA NX19-mod. (standard density)</td> <td>-10°C to +30°C</td> </tr> <tr> <td>GOST30319-2</td> <td>-23°C to +76°C</td> </tr> </table> <p>In pressure range up to 15 bar:</p> <table border="0"> <tr> <td>GERG88S</td> <td>-25°C to +65°C</td> </tr> <tr> <td>GERGS-mod-H2</td> <td>-25°C to +65°C</td> </tr> <tr> <td>AGA8 GROSS Meth. 1</td> <td>-10°C to +55°C</td> </tr> <tr> <td>AGA8 GROSS Meth. 2</td> <td>-10°C to +55°C</td> </tr> <tr> <td>AGA NX19-mod. (relative density)</td> <td>-10°C to +30°C</td> </tr> <tr> <td>AGA NX19-mod. (standard density)</td> <td>-10°C to +30°C</td> </tr> <tr> <td>GOST30319-2</td> <td>-23°C to +76°C</td> </tr> </table> <p>GERG88S will be the gas model, which is most often chosen. Therefore, these temperature values (assuming a pressure of 20 bar) are set as default for the min/max values in menu D Temperature for D04 Min and D05 Max. Adjust these limits if necessary.</p> <p>The calculation method performs a check of the permissible input variables (e.g., temperature, pressure, standard calorific value, etc.). If the limits are exceeded or not reached, then an error is generated, and the calculation is performed with the default value of the C-number.</p> <div style="border: 2px solid black; padding: 5px; margin-top: 10px;"> <p><b>Note</b></p> <p><b>In this case, the RSM 200 detects an error event, indicates this as an error during the conversion, and adds accumulating volumes to the error counter <math>V_{b\ err}</math>.</b></p> </div> <p><b>C coefficient constant</b>                      The simplest option is to set the compressibility constant. This is correct if you work with the same measuring gas and know the compressibility coefficient. Enter this coefficient in E02. The</p>	GERG88S	-20°C to +65°C	GERGS-mod-H2	-20°C to +65°C	AGA8 GROSS Meth. 1	-10°C to +55°C	AGA8 GROSS Meth. 2	-10°C to +55°C	AGA NX19-mod. (relative density)	-10°C to +30°C	AGA NX19-mod. (standard density)	-10°C to +30°C	GOST30319-2	-23°C to +76°C	GERG88S	-25°C to +65°C	GERGS-mod-H2	-25°C to +65°C	AGA8 GROSS Meth. 1	-10°C to +55°C	AGA8 GROSS Meth. 2	-10°C to +55°C	AGA NX19-mod. (relative density)	-10°C to +30°C	AGA NX19-mod. (standard density)	-10°C to +30°C	GOST30319-2	-23°C to +76°C
GERG88S	-20°C to +65°C																													
GERGS-mod-H2	-20°C to +65°C																													
AGA8 GROSS Meth. 1	-10°C to +55°C																													
AGA8 GROSS Meth. 2	-10°C to +55°C																													
AGA NX19-mod. (relative density)	-10°C to +30°C																													
AGA NX19-mod. (standard density)	-10°C to +30°C																													
GOST30319-2	-23°C to +76°C																													
GERG88S	-25°C to +65°C																													
GERGS-mod-H2	-25°C to +65°C																													
AGA8 GROSS Meth. 1	-10°C to +55°C																													
AGA8 GROSS Meth. 2	-10°C to +55°C																													
AGA NX19-mod. (relative density)	-10°C to +30°C																													
AGA NX19-mod. (standard density)	-10°C to +30°C																													
GOST30319-2	-23°C to +76°C																													

Coordinate	Name	Description																		
		<p>compressibility coefficient is set to "1" for an ideal gas (e.g., gases at low pressure).</p> <p>Complete gas analyses are not necessary for any other gas models, but knowledge of additional gas parameters is necessary. Depending on the model, these are to be entered in <b>coordinates E07 to E12</b>; only the required coordinates are shown:</p> <table border="1"> <tbody> <tr> <td>E07</td> <td>Standard calorific value</td> <td>kWh/m<sup>3</sup></td> </tr> <tr> <td>E08</td> <td>Standard density</td> <td>kg/m<sup>3</sup></td> </tr> <tr> <td>E09</td> <td>Density ratio</td> <td></td> </tr> <tr> <td>E10</td> <td>Percentage of carbon dioxide CO<sub>2</sub></td> <td>mol-%</td> </tr> <tr> <td>E11</td> <td>Percentage of nitrogen N<sub>2</sub></td> <td>mol-%</td> </tr> <tr> <td>E12</td> <td>Percentage of hydrogen H<sub>2</sub></td> <td>mol-%</td> </tr> </tbody> </table> <p><b>GERG 88 S</b> This equation requires the following fixed input variables: Standard calorific value (E07), standard density (E08), as well as the gas proportions (in mol-%) of carbon dioxide (E10) and hydrogen (E12) The maximum H2 content here is 10-mol%.</p> <p><b>GERG S-mod-H2</b> This equation is an extension of Gerg 88 S when a higher percentage of H2 (up to 30 mol%) is present in the gas. Otherwise, the same input variables are required: Standard calorific value (E07), standard density (E08), as well as the gas contents (in mol-%) of carbon dioxide (E10) and hydrogen (E12).</p> <p><b>AGA 8 Gross method 1</b> This calculation method corresponds to GERG 88 S with the special feature that the hydrogen content (E12) is assumed to be 0 mol%.</p> <p><b>AGA 8 Gross method 2</b> This equation requires the following fixed input variables: Standard density (E08), and the gas contents (in mol-%) of carbon dioxide (E10) and nitrogen (E11). The hydrogen content is assumed to be 0 mol%, analogous to AGA8 Gross method 1.</p> <p><b>AGA NX-19-mod. (Density ratio)</b> This equation requires the following fixed input variables: Standard density (E09), standard calorific value (E07), as well as the gas contents (in mol-%) of carbon dioxide (E10) and Nitrogen (E11).</p> <p><b>AGA NX19-mod. (standard density)</b> Die Eingangsgrößen dieser Gleichung sind: Standard density (E08), standard calorific value (E07), as well as the gas contents (in mol-%) of carbon dioxide (E10) and Nitrogen (E11).</p>	E07	Standard calorific value	kWh/m <sup>3</sup>	E08	Standard density	kg/m <sup>3</sup>	E09	Density ratio		E10	Percentage of carbon dioxide CO <sub>2</sub>	mol-%	E11	Percentage of nitrogen N <sub>2</sub>	mol-%	E12	Percentage of hydrogen H <sub>2</sub>	mol-%
E07	Standard calorific value	kWh/m <sup>3</sup>																		
E08	Standard density	kg/m <sup>3</sup>																		
E09	Density ratio																			
E10	Percentage of carbon dioxide CO <sub>2</sub>	mol-%																		
E11	Percentage of nitrogen N <sub>2</sub>	mol-%																		
E12	Percentage of hydrogen H <sub>2</sub>	mol-%																		

Coordinate	Name	Description																								
		<div style="border: 1px solid black; background-color: #000080; color: white; padding: 2px; text-align: center;"><b>Note</b></div> <div style="border: 1px solid black; padding: 5px; margin-top: 5px;"> <p><b>For both AGA NX19 variants, the conversion changes from low energy gas to high energy gas when the standard calorific value of the gas is above 39.8 MJ/m<sup>3</sup>.</b></p> </div> <p><b>GOST30319-2</b> This is a Russian regulation for determining the real gas factors. For more details, see the Russian manual.</p>																								
E06	§Default compr. factor	Default value for the C coefficient																								
E07	§Calorific value	Calorific value at standard conditions																								
E08	§Standard density	Standard density																								
E09	§Relative Density	Density ratio (standard density gas / standard density air)																								
E10	§Carbon dioxide	Percentage of carbon dioxide																								
E11	§Nitrogen	Percentage of nitrogen																								
E12	§Hydrogen	Percentage of hydrogen																								
E20	§Standard pressure	Display of the value selected at E23 for the standard pressure.																								
E21	§Standard temperature	Display of the value selected at E23 for standard temperature.																								
E22	§Standard cal. value temp.	Display of the value selected at E23 for standard calorific value temperature.																								
E23	§Reference condition	<p>Number of standard conditions</p> <table border="1" style="width: 100%; border-collapse: collapse; text-align: center;"> <thead> <tr> <th></th> <th>E20</th> <th>E21</th> <th>E22</th> </tr> </thead> <tbody> <tr> <td>Combination 1</td> <td>1,01325 bar 14,7 psi</td> <td>0°C 32°F</td> <td>25°C 77°F (default)</td> </tr> <tr> <td>Combination 2</td> <td>1,01325 bar 14.7 psi</td> <td>0°C 32°F</td> <td>0°C 32°F</td> </tr> <tr> <td>Combination 3</td> <td>1,01325 bar 14.7 psi</td> <td>15°C 59°F</td> <td>15°C 59°F</td> </tr> <tr> <td>Combination 4</td> <td>1,02 bar 14.73 psi</td> <td>15.56°C 60°F</td> <td>15.56°C 60°F</td> </tr> <tr> <td>Combination 5</td> <td>1.01325 bar 14.7 psi</td> <td>20°C 68°F</td> <td>25°C 77°F</td> </tr> </tbody> </table> <p><b>Norm or reference conditions</b> In Germany, standard conditions under which gas parameters must be determined are defined. These standard conditions are for the pressure (E20), 1.01325 bar and the temperature (E21) 0°C. In addition, 25°C applies as a standard combustion temperature for determining the calorific value (E22).</p>		E20	E21	E22	Combination 1	1,01325 bar 14,7 psi	0°C 32°F	25°C 77°F (default)	Combination 2	1,01325 bar 14.7 psi	0°C 32°F	0°C 32°F	Combination 3	1,01325 bar 14.7 psi	15°C 59°F	15°C 59°F	Combination 4	1,02 bar 14.73 psi	15.56°C 60°F	15.56°C 60°F	Combination 5	1.01325 bar 14.7 psi	20°C 68°F	25°C 77°F
	E20	E21	E22																							
Combination 1	1,01325 bar 14,7 psi	0°C 32°F	25°C 77°F (default)																							
Combination 2	1,01325 bar 14.7 psi	0°C 32°F	0°C 32°F																							
Combination 3	1,01325 bar 14.7 psi	15°C 59°F	15°C 59°F																							
Combination 4	1,02 bar 14.73 psi	15.56°C 60°F	15.56°C 60°F																							
Combination 5	1.01325 bar 14.7 psi	20°C 68°F	25°C 77°F																							

100

Coordinate	Name	Description
		<p><b>Note</b></p> <p>For the European area of application, the standard conditions are <b>not uniform</b> with respect to various pressure / temperature values. In the United States, conversions to the units "psi" and "°F" apply.</p> <p>In general, care should be taken, because the pressure / temperature values for the respective standard conditions may deviate from the German standard values. Disregard can result in signification conversion errors.</p>
E24	T/P sample time	Within this time, a new pressure and temperature value is read from the sensors and converted into real gas factor Z, calorific number C, ... according to the selected model.

### 6.8.6. Current outputs

**Note**

The current output is provided, but currently not implemented. Further additions may therefore be made to this section.

It is intended that the analog output will work as follows:

Coordinate	Name	Description										
F01	Current	Current to be output										
F02	Current mode	<p>Mode of the current output</p> <table border="1"> <tr> <td>0</td> <td>Off (default)</td> </tr> <tr> <td>1</td> <td>Specification</td> </tr> <tr> <td>2</td> <td>4-20 mA</td> </tr> <tr> <td>3</td> <td>Error 3.5 mA</td> </tr> <tr> <td>4</td> <td>Error 21.8 mA</td> </tr> </table> <p>If the current mode is set to "0", i.e. "Off", no parameters of the output other than parameter F02: current mode are visible and adjustable. With "3" or "4", the respective "fault current" is output in the event of a fault: with "3" -&gt; 3.5 mA, with "4" -&gt; 21.8 mA.</p>	0	Off (default)	1	Specification	2	4-20 mA	3	Error 3.5 mA	4	Error 21.8 mA
0	Off (default)											
1	Specification											
2	4-20 mA											
3	Error 3.5 mA											
4	Error 21.8 mA											
F03	Current source	Source of the current output										

Coordinate	Name	Description												
		<table border="1"> <tr><td>0</td><td>Measurement flow rate</td></tr> <tr><td>1</td><td>Calibration 4mA</td></tr> <tr><td>2</td><td>Calibration 20mA</td></tr> <tr><td>3</td><td>Standard flow rate</td></tr> <tr><td>4</td><td>Temperature</td></tr> <tr><td>5</td><td>Pressure</td></tr> </table>	0	Measurement flow rate	1	Calibration 4mA	2	Calibration 20mA	3	Standard flow rate	4	Temperature	5	Pressure
0	Measurement flow rate													
1	Calibration 4mA													
2	Calibration 20mA													
3	Standard flow rate													
4	Temperature													
5	Pressure													
F04	Phys. Minimum value	Assignment 4 mA z.B. 4 mA $\triangleq$ 0 m <sup>3</sup> /h												
F05	Phys. Maximum value	Assignment 20 mA z.B. 20 mA $\triangleq$ 400 m <sup>3</sup> /h (Q <sub>max</sub> bei DN80)												
		<table border="1"> <tr> <td><b>Note</b></td> </tr> <tr> <td>The analog output can have different sources; therefore - depending on your choice - assign "reasonable" values to the physical minimum and maximum values.</td> </tr> </table>	<b>Note</b>	The analog output can have different sources; therefore - depending on your choice - assign "reasonable" values to the physical minimum and maximum values.										
<b>Note</b>														
The analog output can have different sources; therefore - depending on your choice - assign "reasonable" values to the physical minimum and maximum values.														
F06	Current Default	Specification value for the current output (e.g. for testing purposes)												
F07	Current damping	The current output is damped by means of averaging. A value of 0 corresponds to no damping. A value of 0.99 causes heavy damping.												

### 6.8.7. Information

Coordinate	Name	Description						
G01	§Year of manufacture	Year of manufacture of the instrument.						
		<table border="1"> <tr> <td><b>Note</b></td> </tr> <tr> <td>The year of manufacture must be entered correctly.</td> </tr> </table>	<b>Note</b>	The year of manufacture must be entered correctly.				
<b>Note</b>								
The year of manufacture must be entered correctly.								
G02	§Software version	Shows the version number of the firmware.						
G04	§Serial number	Serial number of the RSM 200						
G05	§Firmware checksum	Shows the checksum of the firmware						
G06	Measuring point	Possibility of alphanumeric identification for the measuring point						
G07	§Device type	Shows the device type of RSM 200						
		<table border="1"> <tr> <td>RSM200 VM</td> <td>– Only volume counter</td> </tr> <tr> <td>RSM200 VC</td> <td>– Volume counter with converter</td> </tr> <tr> <td>RSM200 VM F</td> <td>– Volume counter with converter, fiscal</td> </tr> </table>	RSM200 VM	– Only volume counter	RSM200 VC	– Volume counter with converter	RSM200 VM F	– Volume counter with converter, fiscal
RSM200 VM	– Only volume counter							
RSM200 VC	– Volume counter with converter							
RSM200 VM F	– Volume counter with converter, fiscal							

Coordinate	Name	Description
		RSM200 VC F – Volume counter with converter, fiscal
G10	§Standard pressure	Indicates the standard pressure selected in E23 Reference condition.
G11	§Min. pressure	Specifies the lower limit of the pressure sensor.
G12	§Max. pressure	Specifies the upper limit of the pressure sensor. Within these limits G11 and G12 the accuracy specified in <i>chapter 7.2.2 Pressure transducer</i> is guaranteed. These values are the default values for C04 and C05.
G13	§Serial no. pressure sensor	Serial number of the pressure sensor  <div style="border: 1px solid black; padding: 5px;"> <p><b>Note</b></p> <p>The serial number must be entered correctly; only then is a correct printout in C01 possible.</p> </div>
G14	§Standard temperature	Indicates the standard temperature selected in E23 Reference condition.
G15	§Min. temp.	Specifies the lower limit of the pressure sensor.
G16	§Max. temp.	Specifies the upper limit of the pressure sensor. Within these limits G15 and G16 the accuracy specified in <i>chapter 7.2.1 Temperature sensor</i> is guaranteed.
G17	§Serial no. temp. sensor	Serial number of the temperature sensor  <div style="border: 1px solid black; padding: 5px;"> <p><b>Note</b></p> <p>The serial number must be entered correctly; only then is a correct printout in D01 possible.</p> </div>
G18	§Meter number	Serial number of the RSM 200
G23	§Batt. New dd.mm.yy	<div style="border: 1px solid black; padding: 5px;"> <p><b>Note</b></p> <p>At the first operation (use in battery mode) with "G25 Date battery change" a "yes" this date is set for the first time; it is updated thereby. Only then the calculation in G24 will work correctly.</p> </div> <p>Each time the battery is changed again, a "yes" in G25 results in an updated date in G23.</p>
G24	§Remaining Batt. Cap	Shows the remaining capacity of the battery in percent [%].

Coordinate	Name	Description				
G25	Battery change	<table border="1"> <tr> <td>-</td> <td>- (Default)</td> </tr> <tr> <td>1</td> <td>Yes Respect the type of battery: see <i>chapter 5.1.2 Battery replacement</i></td> </tr> </table>	-	- (Default)	1	Yes Respect the type of battery: see <i>chapter 5.1.2 Battery replacement</i>
-	- (Default)					
1	Yes Respect the type of battery: see <i>chapter 5.1.2 Battery replacement</i>					
G27	§Battery capacity	Shows the capacity of the battery in percent [Ah].				
G28	§Operating mode	Indicates whether the device is active with battery as power supply in normal operation or sleep mode.				

### 6.8.8. Communication

Coordinate	Name	Description												
H01	Modbus ID	Modbus device address (default = 1; setting range: 1..247)												
H02	Modbus register offset	The offset is defined as 1 by RMG. (Setting range 0..10000)												
H03	RS-485 Onboard baud rate	<table border="1"> <tr> <td>0</td> <td>2400 Bps</td> </tr> <tr> <td>1</td> <td>9600 Bps</td> </tr> <tr> <td>2</td> <td>19200 Bps</td> </tr> <tr> <td>3</td> <td>38400 Bps (default)</td> </tr> </table>	0	2400 Bps	1	9600 Bps	2	19200 Bps	3	38400 Bps (default)				
0	2400 Bps													
1	9600 Bps													
2	19200 Bps													
3	38400 Bps (default)													
H04	RS-485 Onboard parameter	<table border="1"> <tr> <td>0</td> <td>8N1 (default)</td> </tr> <tr> <td>1</td> <td>8E1</td> </tr> <tr> <td>2</td> <td>8O1</td> </tr> <tr> <td>3</td> <td>7N1</td> </tr> <tr> <td>4</td> <td>7E1</td> </tr> <tr> <td>5</td> <td>7O1</td> </tr> </table>	0	8N1 (default)	1	8E1	2	8O1	3	7N1	4	7E1	5	7O1
0	8N1 (default)													
1	8E1													
2	8O1													
3	7N1													
4	7E1													
5	7O1													
H05	RS485 Onboard protocol	<table border="1"> <tr> <td>0</td> <td>Off (default, only choice in battery mode)</td> </tr> <tr> <td>1</td> <td>Modbus RTU</td> </tr> <tr> <td>2</td> <td>Modbus ASCII</td> </tr> </table>	0	Off (default, only choice in battery mode)	1	Modbus RTU	2	Modbus ASCII						
0	Off (default, only choice in battery mode)													
1	Modbus RTU													
2	Modbus ASCII													
H06	Optical baud rate	<table border="1"> <tr> <td>0</td> <td>2400 Bps</td> </tr> <tr> <td>1</td> <td>9600 Bps</td> </tr> <tr> <td>2</td> <td>19200 Bps</td> </tr> <tr> <td>3</td> <td>38400 Bps (default)</td> </tr> </table>	0	2400 Bps	1	9600 Bps	2	19200 Bps	3	38400 Bps (default)				
0	2400 Bps													
1	9600 Bps													
2	19200 Bps													
3	38400 Bps (default)													

104

Coordinate	Name	Description												
		<table border="1"> <tr> <th colspan="2">Note</th> </tr> <tr> <td colspan="2"> <p>After a crash of the RSM 200, the restart of the RMGView<sup>RSM</sup> may be disturbed. In general, the baud rate of the RSM is then unchanged at 38400 Bps. If necessary, the selection of a lower baud rate (e.g. 9600 Bps) can enable the start. After a successful start (with low baud rate), the baud rate can be "set high" again; the RMGView<sup>RSM</sup> must then be restarted.</p> </td> </tr> </table>	Note		<p>After a crash of the RSM 200, the restart of the RMGView<sup>RSM</sup> may be disturbed. In general, the baud rate of the RSM is then unchanged at 38400 Bps. If necessary, the selection of a lower baud rate (e.g. 9600 Bps) can enable the start. After a successful start (with low baud rate), the baud rate can be "set high" again; the RMGView<sup>RSM</sup> must then be restarted.</p>									
Note														
<p>After a crash of the RSM 200, the restart of the RMGView<sup>RSM</sup> may be disturbed. In general, the baud rate of the RSM is then unchanged at 38400 Bps. If necessary, the selection of a lower baud rate (e.g. 9600 Bps) can enable the start. After a successful start (with low baud rate), the baud rate can be "set high" again; the RMGView<sup>RSM</sup> must then be restarted.</p>														
H07	Optical parameter	<table border="1"> <tr><td>0</td><td>8N1 (default)</td></tr> <tr><td>1</td><td>8E1</td></tr> <tr><td>2</td><td>8O1</td></tr> <tr><td>3</td><td>7N1</td></tr> <tr><td>4</td><td>7E1</td></tr> <tr><td>5</td><td>7O1</td></tr> </table>	0	8N1 (default)	1	8E1	2	8O1	3	7N1	4	7E1	5	7O1
0	8N1 (default)													
1	8E1													
2	8O1													
3	7N1													
4	7E1													
5	7O1													
H08	Optical protocol	<table border="1"> <tr><td>0</td><td>Off</td></tr> <tr><td>1</td><td>Modbus RTU (default)</td></tr> <tr><td>2</td><td>Modbus ASCII</td></tr> </table>	0	Off	1	Modbus RTU (default)	2	Modbus ASCII						
0	Off													
1	Modbus RTU (default)													
2	Modbus ASCII													
H09	RS485 optional, external baud rate	<table border="1"> <tr><td>0</td><td>2400 Bps</td></tr> <tr><td>1</td><td>9600 Bps</td></tr> <tr><td>2</td><td>19200 Bps</td></tr> <tr><td>3</td><td>38400 Bps (default)</td></tr> </table>	0	2400 Bps	1	9600 Bps	2	19200 Bps	3	38400 Bps (default)				
0	2400 Bps													
1	9600 Bps													
2	19200 Bps													
3	38400 Bps (default)													
H10	RS485 optional, external parameters	<table border="1"> <tr><td>0</td><td>8N1 (default)</td></tr> <tr><td>1</td><td>8E1</td></tr> <tr><td>2</td><td>8O1</td></tr> <tr><td>3</td><td>7N1</td></tr> <tr><td>4</td><td>7E1</td></tr> <tr><td>5</td><td>7O1</td></tr> </table>	0	8N1 (default)	1	8E1	2	8O1	3	7N1	4	7E1	5	7O1
0	8N1 (default)													
1	8E1													
2	8O1													
3	7N1													
4	7E1													
5	7O1													
H11	RS485 optional, external protocol	<table border="1"> <tr><td>0</td><td>Off</td></tr> <tr><td>1</td><td>Modbus RTU (default)</td></tr> <tr><td>2</td><td>Modbus ASCII</td></tr> </table>	0	Off	1	Modbus RTU (default)	2	Modbus ASCII						
0	Off													
1	Modbus RTU (default)													
2	Modbus ASCII													



## Note

### F instance

**The values of the F instance can be called up via the Modbus RTU protocol. The following interface settings must be selected for this:**

Coordinate "H05 RS485 onboard protocol": 1 = Modbus RTU (default)

Coordinate "H03 RS485 onboard baud rate": 3 = 38400 Bps (default)

Coordinate "H04 RS485 onboard parameter": 0 = 8N1 (default)

### 6.8.9. USM measured values

Coordinate	Name	Description
I02	Gas velocity	Average speed of the measuring gas (VoG).
I03	Speed of sound	Average speed of the measuring gas
I04	§Flow direction	Flow direction: The RSM 200 is unidirectional, i.e. it has only one flow direction, which is indicated by an arrow. Please ensure correct mounting during installation.
I05	P1/P2 Gas velocity	Ratio of the gas velocities in the measuring paths. The calculation is only active above 0.3 m/s. If the velocity of one of the two measuring paths is below 0.3 m/s, then this quotient is frozen at 1.00000. If there is a path failure, then this quotient is set to 0.00000 - independent of the present velocity.
I07	P1/P2 Speed of sound	Ratio of sound speeds in the measurement paths.
I09	§P1 Acceptance rate	Number of valid measurements in measurement path 1.
I11	P1 Gas velocity	Gas speed measurement path 1.
I12	P1 Speed of sound	Speed of sound measurement path 1.
I13	§P2 Acceptance rate	Number of valid measurements in measurement path 2.
I15	P2 Gas velocity	Gas speed measurement path 2.
I16	P2 Speed of sound	Speed of sound measurement path 2.
I17	AR Combined	Combined acceptance rate averaged over both measurement paths; required for the F instance.

### 6.8.10. Measurement path 1 Diagnosis

Coordinate	Name	Description
J11	P1BA_SNR	SNR (signal-to-noise ratio) of the measurement J01
J12	P1AB_SNR	SNR (signal-to-noise ratio) of the measurement J02
J15	P1BA_AGC Actual	Current electronic gain (AGC = automatic gain control) of the received signal of the measurement J01
J16	P1AB_AGC Actual	Current electronic gain (AGC = automatic gain control) of the received signal of the measurement J02

### 6.8.11. Measurement path 2 Diagnosis

Coordinate	Name	Description
K11	P2BA_SNR	SNR (signal-to-noise ratio) of the measurement K01
K12	P2AB_SNR	SNR (signal-to-noise ratio) of the measurement K02
K15	P2BA_AGC Actual	Current electronic gain (AGC = automatic gain control) of the received signal of the measurement K01
K16	P2AB_AGC Actual	Current electronic gain (AGC = automatic gain control) of the received signal of the measurement K02

### 6.8.12. USM Parameter

Coordinate	Name	Description
L01	Smoothing filter	Smooths the speed measurement by dynamic averaging. A value of 1.0 does not correspond to an averaging. A value of 0.001 causes a very strong averaging
L02	Measurement rate	Number of measurements per second A maximum of 4 complete speed measurements per second should be set.
L03	Size median filter	An incorrect measurement during runtime determination is replaced by a substitute value. The median of the last "n" measurements (max. 20) serves as a substitute value.
L05	Warning AGC	Warning that the maximum electrical amplification has been exceeded.
L06	Warning SNR	Warning that a minimum SNR has not been reached.
L07	Warning VoG max.	Warning, maximum gas speed has been exceeded.
L08	§Min Err search	Used to determine the slope of the envelope of the useful signal (typical: 10%).
L09	§Max Err measure	Used to determine the slope of the envelope of the useful signal (typical: 40 %)

L10	Limit SNR min	Alarm that a minimum SNR has not been reached.								
L11	§Limit Signal min	Minimum signal amplitude in per cent (typically: 10%)								
L12	§Limit Signal max	Maximum signal amplitude in per cent (typically: 100%), can be reduced to avoid clipping.								
L13	§AGC Mode	Selection menu <table border="1"> <tr> <td>0</td> <td>AGC Off, Boost on</td> </tr> <tr> <td>1</td> <td>AGC On, Boost on (default)</td> </tr> <tr> <td>2</td> <td>AGC Off, Boost off</td> </tr> <tr> <td>3</td> <td>AGC On, Boost off</td> </tr> </table>	0	AGC Off, Boost on	1	AGC On, Boost on (default)	2	AGC Off, Boost off	3	AGC On, Boost off
0	AGC Off, Boost on									
1	AGC On, Boost on (default)									
2	AGC Off, Boost off									
3	AGC On, Boost off									
L14	§AGC Initvalue	Start value of the gain control. With AGC Off, this value is held permanently.								
L15	§SignalMax Setpoint	Setpoint for the signal amplitude for AGC On.								
L18	§Transmit Freq.	Output frequency of the sensor (DN50 240: kHz; DN80-DN150: 200kHz; DN200 160 kHz)								
L19	§Transmit Pulses	Number of emitted pulses								
L20	§Receive Pulses	Number of evaluated pulses								
L21	§RxMinAmplitude	Analysis parameter								
L22	§ToF Mode	Method of transit time determination								
L27	§HinkleyAlpha	Analysis parameter								

### 6.8.13. Adjust USM

Coordinate	Name	Description
M01	§Inner diameter	Diameter of the inner cell
M02	§P1 length	Length of the measuring path
M03	§P1 angle	Angle towards the pipe axis
M04	§P1 length sensor A	Sensor length A
M05	§P1 length sensor B	Sensor length B
M06	§P2 length	Length of the measuring path
M07	§P2 angle	Angle towards the pipe axis
M08	§P2 length sensor A	Sensor length A
M09	§P2 length sensor B	Sensor length B
M10	§P1 TW	Time difference; used to adjust SoS
M11	§P1 Delta T offset	Transit time difference
M12	§P2 TW	Time difference; used to adjust SoS
M13	§P2 Delta T offset	Transit time difference

### 6.8.14. Reynolds correction

Coordinate	Name	Description										
N01	§Reynolds number	Calculates the current Reynolds number										
N02	§Reynolds number minimum	<p>The basic characteristic curve (baseline) is stored as Reynolds correction, i.e. a percentage deviation from the simple flow rate calculation (average velocity x pipe cross-section) is corrected as a function of the Reynolds number (see <i>chapter 3.3 Basic curve and Reynolds number</i>).</p> <p>Below minimum Reynolds number (<math>Re_{min}</math>) no correction by the determination polynomial takes place, the correction at <math>Re_{min}</math> is frozen and below <math>Re_{min}</math> applied to the uncorrected measured value.</p> <div style="border: 1px solid black; padding: 5px; margin-top: 10px;"> <p><b>Note</b></p> <p>The Reynolds correction is a consideration of the basic characteristic curve (see chapter 3.3 Basic characteristic curve and Reynolds number). In order to take this correction into account over the entire Reynolds number range (or at least the essential range), it is advisable to set this value to a minimum, e.g.</p> <p style="text-align: center;"><b><math>Re_{min} = 100.</math></b></p> <p>This value generally corresponds to a value below <math>Q_{min}</math>.</p> <p>It is not possible to select <math>Re_{min} = 0</math> due to the internal logarithmic handling of this value.</p> </div>										
N05	§Reynolds correction	<p>This determines whether a correction is made over the Reynolds number. The basic characteristic curve (baseline), which takes into account a deviation from the simple flow rate calculation (average velocity x pipe cross-section) as a function of the Reynolds number, is considered.</p> <p>This provides an improvement in measurement accuracy for small and especially very small flow rates. Available for selection:</p> <table border="1" style="width: 100%; border-collapse: collapse;"> <tbody> <tr> <td style="text-align: center;">0</td> <td>Off (default)</td> </tr> <tr> <td style="text-align: center;">1</td> <td>Auto (RSM 200 VC(F); with T and p sensor)</td> </tr> <tr> <td style="text-align: center;">2</td> <td>Auto (RMS200 VM(F); T from c; p as fixed value)</td> </tr> <tr> <td style="text-align: center;">3</td> <td>Manual (RSM 200 VC(F); with T and p sensor)</td> </tr> <tr> <td style="text-align: center;">4</td> <td>Manual (RMS200 VM(F); T from c; p as fixed value)</td> </tr> </tbody> </table> <p><b>0:</b> Without correction</p> <p><b>1:</b> Automatic mode on. This determines whether air or natural gas is present based on the speed of sound (default is a natural gas H, with 98.302% CH<sub>4</sub>; 1.36% N<sub>2</sub>; 0.338% CO<sub>2</sub>)</p>	0	Off (default)	1	Auto (RSM 200 VC(F); with T and p sensor)	2	Auto (RMS200 VM(F); T from c; p as fixed value)	3	Manual (RSM 200 VC(F); with T and p sensor)	4	Manual (RMS200 VM(F); T from c; p as fixed value)
0	Off (default)											
1	Auto (RSM 200 VC(F); with T and p sensor)											
2	Auto (RMS200 VM(F); T from c; p as fixed value)											
3	Manual (RSM 200 VC(F); with T and p sensor)											
4	Manual (RMS200 VM(F); T from c; p as fixed value)											

Coordinate	Name	Description
		<p>and <math>\eta = 10.2 \times 10^{-6} Pa \cdot s</math>). Fixed values can be entered for pressure (p) and temperature (T), or data from connected sensors can be used. For fixed values, the determination of the present Reynolds number is possible only with limited accuracy.</p> <p><b>2:</b> Alternatively, the temperature can be "back-calculated" from the speed of sound, which is determined using the ultrasonic measuring principle. The temperature determined in this way is generally much more accurate than a fixed value; the default fixed value is always used as the pressure in this mode.</p> <p><b>3:</b> If the gas does not correspond to a natural gas H with the specified values, then the accuracy of the Reynolds number determination and the temperature calculation can be increased if the individual gas parameters are known (gas composition and dynamic viscosity). These parameters can be entered into an Excel program, which then allows a more accurate determination for natural gas-like gases.</p> <p>This calculation should be carried out by RMG Service. The parameters determined in this way can only be entered in expert mode. Fixed values can be entered for the pressure (p) and the temperature (T) or the corresponding data from connected sensors can be used. With fixed values, the determination of the present Reynolds number is only possible with limited accuracy.</p> <p><b>4:</b> A temperature determination from the sound velocity can also be selected here (B2, B1 and B0); the default fixed value is always used as the pressure in this mode.</p>
N06	Detected medium	Display value air or natural gas in automatic mode. In manual measurement mode, "-" is displayed.
N07	§Corr. -Coeff. -2	Coefficient of the base line
N08	§Corr. -Coeff. -1	Coefficient of the base line
N09	§Corr. -Coeff. 0	Coefficient of the base line
N10	§Corr. -Coeff. 1	Coefficient of the base line
N11	§Corr. -Coeff. 2	Coefficient of the base line
N12	§MF -Coeff. A2	Coefficient to determine the medium factor
N13	§MF -Coeff. A1	Coefficient to determine the medium factor
N14	§MF -Coeff. A0	Coefficient to determine the medium factor
N15	§T(c) -Coeff. B2	Coefficient to calculate the temperature from the SoS
N16	§T(c) -Coeff. B1	Coefficient to calculate the temperature from the SoS
N17	§T(c) -Coeff. B0	Coefficient to calculate the temperature from the SoS
N19	Correction function	Selection menu:

Coordinate	Name	Description				
		<table border="1"> <tr> <td>0</td> <td>Polynom (default)</td> </tr> <tr> <td>1</td> <td>Arctan</td> </tr> </table>	0	Polynom (default)	1	Arctan
0	Polynom (default)					
1	Arctan					
		Function selection (Polynom/Arctan) to correct the baseline using the coefficients N07 to N11				

The *annex F Calculation of the Reynolds number* contains details on the Reynolds number calculation and on how to use the Excel tool.

### 6.8.15. Signal search

Coordinate	Name	Description
R01	SoS min	Min. speed of sound
R02	SoS max	Max. speed of sound
R03	Expected SoS	Expected value of the speed of sound: Air: 342 m/s Gas: 440 m/s
R05	§Size search win	Analysis parameter
R06	§Size meas. win	Analysis parameter
R07	§ADC resolution	Amplification parameter
R08	§Time resolution	Analysis parameter

### 6.8.16. Digital outputs

Coordinate	Name	Description																		
S01	§Dig. Out 1 mode	Mode of the digital output																		
		<table border="1"> <tr> <td>0</td> <td>Off (default)</td> </tr> <tr> <td>1</td> <td>LF Channel 1</td> </tr> <tr> <td>2</td> <td>LF Channel 2</td> </tr> <tr> <td>3</td> <td>Alarm (mains operation only)</td> </tr> <tr> <td>4</td> <td>Alarm inverse (inverted alarm signal) (mains operation only)</td> </tr> <tr> <td>5</td> <td>Warning (mains operation only)</td> </tr> <tr> <td>6</td> <td>Warning inverse (inverted alarm signal) (mains op. only)</td> </tr> <tr> <td>7</td> <td>HF inverse + alarm (mains operation only)</td> </tr> <tr> <td>8</td> <td>Encoder</td> </tr> </table>	0	Off (default)	1	LF Channel 1	2	LF Channel 2	3	Alarm (mains operation only)	4	Alarm inverse (inverted alarm signal) (mains operation only)	5	Warning (mains operation only)	6	Warning inverse (inverted alarm signal) (mains op. only)	7	HF inverse + alarm (mains operation only)	8	Encoder
0	Off (default)																			
1	LF Channel 1																			
2	LF Channel 2																			
3	Alarm (mains operation only)																			
4	Alarm inverse (inverted alarm signal) (mains operation only)																			
5	Warning (mains operation only)																			
6	Warning inverse (inverted alarm signal) (mains op. only)																			
7	HF inverse + alarm (mains operation only)																			
8	Encoder																			

Coordinate	Name	Description																
S02	§Dig. Out 2 mode	<p>Mode of the digital output 2</p> <table border="1"> <tr><td>0</td><td>Off (default)</td></tr> <tr><td>1</td><td>LF Channel 1</td></tr> <tr><td>2</td><td>LF Channel 2</td></tr> <tr><td>3</td><td>HF (mains operation only)</td></tr> <tr><td>4</td><td>Alarm (mains operation only)</td></tr> <tr><td>5</td><td>Alarm inverse (mains operation only)</td></tr> <tr><td>6</td><td>Warning (mains operation only)</td></tr> <tr><td>7</td><td>Warning inverse (mains operation only)</td></tr> </table> <div style="border: 2px solid black; padding: 5px; margin-top: 10px;"> <p><b>Note</b></p> <p>As a high-frequency output, DO2 is to be preferred over DO1; DO2 is the primary signal. DO1 is the correction channel, which is also superimposed with the alarm output.</p> </div>	0	Off (default)	1	LF Channel 1	2	LF Channel 2	3	HF (mains operation only)	4	Alarm (mains operation only)	5	Alarm inverse (mains operation only)	6	Warning (mains operation only)	7	Warning inverse (mains operation only)
0	Off (default)																	
1	LF Channel 1																	
2	LF Channel 2																	
3	HF (mains operation only)																	
4	Alarm (mains operation only)																	
5	Alarm inverse (mains operation only)																	
6	Warning (mains operation only)																	
7	Warning inverse (mains operation only)																	
S03	§Digital output 3 mode	<p>Mode of the digital output 3</p> <table border="1"> <tr><td>0</td><td>Off (default)</td></tr> <tr><td>1</td><td>LF Channel 1</td></tr> <tr><td>2</td><td>Alarm (mains operation only)</td></tr> <tr><td>3</td><td>Alarm inverse (mains operation only)</td></tr> <tr><td>4</td><td>Warning (mains operation only)</td></tr> <tr><td>5</td><td>Warning inverse (mains operation only)</td></tr> </table>	0	Off (default)	1	LF Channel 1	2	Alarm (mains operation only)	3	Alarm inverse (mains operation only)	4	Warning (mains operation only)	5	Warning inverse (mains operation only)				
0	Off (default)																	
1	LF Channel 1																	
2	Alarm (mains operation only)																	
3	Alarm inverse (mains operation only)																	
4	Warning (mains operation only)																	
5	Warning inverse (mains operation only)																	
S04	§Digital output 4 mode	<p>Mode of the digital output 4</p> <table border="1"> <tr><td>0</td><td>Off (default)</td></tr> <tr><td>1</td><td>LF Channel 2</td></tr> </table>	0	Off (default)	1	LF Channel 2												
0	Off (default)																	
1	LF Channel 2																	
S05	§LF Channel 1 Mode	<table border="1"> <tr><td>0</td><td>V.Meas. Total</td></tr> <tr><td>1</td><td>V.Meas. + Err.inv.</td></tr> <tr><td>2</td><td>V.Base Total</td></tr> <tr><td>3</td><td>V.Base + Err.inv.</td></tr> </table>	0	V.Meas. Total	1	V.Meas. + Err.inv.	2	V.Base Total	3	V.Base + Err.inv.								
0	V.Meas. Total																	
1	V.Meas. + Err.inv.																	
2	V.Base Total																	
3	V.Base + Err.inv.																	
S06	§LF Channel 2 Mode	<table border="1"> <tr><td>0</td><td>V.Meas. Total</td></tr> <tr><td>1</td><td>V.Meas. + Err.inv.</td></tr> <tr><td>2</td><td>V.Base Total</td></tr> <tr><td>3</td><td>V.Base + Err.inv.</td></tr> </table>	0	V.Meas. Total	1	V.Meas. + Err.inv.	2	V.Base Total	3	V.Base + Err.inv.								
0	V.Meas. Total																	
1	V.Meas. + Err.inv.																	
2	V.Base Total																	
3	V.Base + Err.inv.																	

Coordinate	Name	Description						
		<p>V.Meas. Total is the sum of A02 Volume measure (undisturbed) + A04 Volume measure Err (= A05 Volume meas. Total), i.e. the sum of all pulses accumulated as volume at measurement conditions, regardless of whether they are undisturbed or disturbed (possibly "faulty"). No volume pulses at measurement conditions are "lost".</p> <p>This applies to the setting "Stop at error" in Z25 Volume metering mode; if "Run at error" is selected in this coordinate, then V.Meas. Total corresponds to the value in A02 Volume measure.</p> <p>V.Base. Total is the sum of A01 Volume base (undisturbed) + A03 Volume base Error, i.e. the sum of all pulses accumulated as volume at base conditions, regardless of whether they are undisturbed or disturbed (possibly " faulty "). No volume pulses at base conditions are "lost".</p> <p>This applies to the setting "Stop at error" in Z25 Volume metering mode; if "Run at error" is selected in this coordinate, then V.Base. Total corresponds to the value in A01 Volume base.</p> <p>With the setting V.Meas. + Err.inv. and V.Base + Err.inv. the pulse output is coupled with an error message; in case of an error, i.e. a disturbed measurement, no further output of pulses takes place (after a possibly still stored output of not yet "processed" pulses).</p> <div style="border: 1px solid black; padding: 5px; margin-top: 10px;"> <p><b>Note</b></p> <p><b>If in battery mode, for example, V.Meas. Total is selected in DO 1 and V.Meas. + Err.inv. is selected in DO 2, then the first pulse in DO 1 which does not (also) accumulate in DO 2 can be interpreted as an alarm or error</b></p> </div>						
S07	§Pulse factor LF	<p>For metric units: Output pulse factor for LF output: Number of pulses per 1 m<sup>3</sup>. For imperial units: Output pulse factor for LF output: Volume [cf] per pulse.</p>						
S08	§Pulse width max. LF	<p>Pulse width of the digital output</p> <table border="1" style="width: 100%; border-collapse: collapse;"> <tr> <td style="width: 50px; text-align: center;">0</td> <td>125 ms (If the receiving electronics allow this, this choice is to be preferred).</td> </tr> <tr> <td style="text-align: center;">1</td> <td>250 ms</td> </tr> <tr> <td style="text-align: center;">2</td> <td>500 ms</td> </tr> </table> <p>The pulse width, together with the pulse value S05 and the maximum flow rate, determines an average pulse output. At 500 ms pulse width it should be below 1 Hz, at 250 ms below 2 Hz and at 125 ms below 4 Hz. If more pulses run up than this maximum output allows, then they are temporarily stored and subsequently output. However, an error message is generated if the capacity of the buffer is exceeded.</p>	0	125 ms (If the receiving electronics allow this, this choice is to be preferred).	1	250 ms	2	500 ms
0	125 ms (If the receiving electronics allow this, this choice is to be preferred).							
1	250 ms							
2	500 ms							



Coordinate	Name	Description																								
		<p>The following maximum LF output pulse factor is recommended per 1 m<sup>3</sup>:</p> <table border="1"> <thead> <tr> <th>Pulse width</th> <th>DN50</th> <th>DN80</th> <th>DN100</th> <th>DN150</th> <th>DN200</th> </tr> </thead> <tbody> <tr> <td>150 ms</td> <td>80</td> <td>30</td> <td>20</td> <td>8</td> <td>5</td> </tr> <tr> <td>250 ms</td> <td>40</td> <td>16</td> <td>10</td> <td>4,5</td> <td>2,7</td> </tr> <tr> <td>500 ms</td> <td>20</td> <td>8</td> <td>5</td> <td>1,8</td> <td>0,9</td> </tr> </tbody> </table> <p><b>In general:</b> If the LF output pulse factor is set to a lower value, the life of the battery is increased.</p>	Pulse width	DN50	DN80	DN100	DN150	DN200	150 ms	80	30	20	8	5	250 ms	40	16	10	4,5	2,7	500 ms	20	8	5	1,8	0,9
Pulse width	DN50	DN80	DN100	DN150	DN200																					
150 ms	80	30	20	8	5																					
250 ms	40	16	10	4,5	2,7																					
500 ms	20	8	5	1,8	0,9																					
S09	§Frequency mode HF	<table border="1"> <tr> <td>0</td> <td>The measurement flow rate is applied to the high frequency (HF) output.</td> </tr> <tr> <td>1</td> <td>Test frequency, adjustable in S12</td> </tr> </table>	0	The measurement flow rate is applied to the high frequency (HF) output.	1	Test frequency, adjustable in S12																				
0	The measurement flow rate is applied to the high frequency (HF) output.																									
1	Test frequency, adjustable in S12																									
S10	§Pulse value HF	<p>For metric units: Output pulse factor for HF output: Number of pulses per 1 m<sup>3</sup> For imperial units: Output pulse factor for HF output: volume [cf] per pulse.</p>																								
S11	§Frequency (Q <sub>max</sub> ) HF	<p>Output frequency of the HF output at Q<sub>max</sub>; this value is determined automatically. The pulse value at <b>S10 Pulse value HF</b> should be set so that the maximum frequency at Q<sub>max</sub> is at a maximum of approx. 4000 Hz.</p>																								
S12	Test frequency HF	Test frequency adjustable up to S11																								
S13	§F Max HF hardware	Maximum output frequency 5000.00 Hz																								
S14	§Flow rate	Display of the current flow rate																								
S15	Nominal frequency HF	Target frequency of the HF output																								
S16	Actual frequency HF	Actual frequency of the HF output																								
S17	Frequency error HF	Relative deviation between S14 and S13																								
S18	Enco. Tel. difference	Time difference between the telegrams																								
S19	Enco. B Tel. occur.	The number indicates after how many telegrams A a telegram B follows.																								
S20	EncoderCRCStart	<p>Enables the correct check of the initial CRC check:</p> <table border="1"> <tr> <td>0</td> <td>ENCODER_CR_START_00</td> </tr> <tr> <td>1</td> <td>ENCODER_CR_START_7F</td> </tr> </table> <p>ERZ2000-NG works with both options, Primus 400 preferable with option (1).</p>	0	ENCODER_CR_START_00	1	ENCODER_CR_START_7F																				
0	ENCODER_CR_START_00																									
1	ENCODER_CR_START_7F																									
S21	Enco. Tel1. delay.	Specifies the delay time until the telegram is sent.																								

### 6.8.17. RnD Parameters

Coordinate	Name	Description
T01	§tSer	Analysis parameter
T02	§MuxOn	Analysis parameter
T03	§BoosterOn	Analysis parameter
T04	§AMPOn	Analysis parameter
T05	§TxSignal	Analysis parameter
T06	§MuxOff	Analysis parameter
T19	Chopper Mode	Analysis parameter
T21	Max. muxon delay %.2f	Analysis parameter
T22	Mux On Long Limit %.2f	Analysis parameter

### 6.8.18. Unit system

Coordinate	Name	Description
U01	§Unit system	0 Metrical (default)
		1 Imperial
U02	§Volume unit	Unit
U03	§Flow unit	Unit
U04	§Impulse unit	Selection menu
		0 l/m <sup>3</sup> (default, if U01 = metric)
		1 cf/l (default, if U01 = imperial)
		2 CCF/l (= 100 cf/l)
3 MCF/l (= 1000 cf/l)		
U05	§Temperature unit	Unit
U06	§Temp. absolute unit	Unit
U07	§Pressure unit	Unit
U08	§Pressure unit abs.	Unit
U09	§Length unit	Unit
U10	§Velocity unit	Unit
U11	§Density unit	Unit
U12	§Calorific unit	Unit

The units of the RSM 200 can be configured as metric (kg, m, s, ...) or imperial (lb [pounds], f [feet], s, ...) . The configuration is done via the **coordinate U01 unit system**. The **Table 10** shows the units used depending on the selected system of units. The unit system must always be set before commissioning or is already preset in the factory.

**Note**

Changing the unit system does not zero all totalizers. Since different units can result in different and possibly incorrect volume readings, you must ensure that the "old" value is subtracted when reading out the totalizer reading.

**Note**

The values in the archives (parameter, event, measured value archives) are stored in the (still valid "old") parameterized unit. After the conversion of the unit system they are not converted, therefore the archive values are no longer valid!

It is therefore recommended to deliberately delete the archives after a unit conversion.

Type of unit	metrical (standard)	Imperial
Volume	m <sup>3</sup>	cf
Flow rate	m <sup>3</sup> /h	cf/h
Temperature	°C	°F
Temperature abs.	°K	°R
Pressure	bar(a)	psia
Pressure abs.	bar(a)	psia
Unit of length	mm	inch
Speed	m/s	ft/s
Density	kg/m <sup>3</sup>	lb/cf
Calorific value	kWh/m <sup>3</sup>	BTU/cf
Current output unit (e.g.)	m <sup>3</sup> /h	cf/h

**Table 10**

The default values are set to metric units and the firmware only uses metric units for internal calculations. Exceptions are the volume counters and the archives; these volume counters are also calculated internally in the firmware in the selected, parameterized unit, values in the archives are stored in this parameterized unit (see Table 10).

116

If the metric system of units is selected (= default setting), then all represented and displayed values of the device (display, RMGView<sup>RSM</sup>) are presented in this metric system of units. If the imperial system of units is selected, then this representation takes place accordingly in the imperial units. A unit conversion, if necessary, takes place before the display and Modbus output or after the display and Modbus input.

Source	Internal unit	External unit (Display, RMGView <sup>RSM</sup> )
Values general	metrical	parameterized
Volume counters	parameterized	parameterized
Measured value, event and parameter archives	parameterized	parameterized

**Table 11**

### Note

The pressure is output or input as either absolute or relative pressure depending on whether a relative pressure sensor, absolute pressure sensor or no sensor is connected. Some values, such as atmospheric pressure, are always output as absolute pressure (relative pressure + atmospheric pressure).

In the European sphere of influence, only absolute pressure sensors are generally used; relative pressure sensors are occasionally used in the North American sphere of influence.

### 6.8.19. Archive

Coordinate	Name	Description	
X01	Time	Input of current time in EU-24 h format 15:26:00 // hh:minmin:ss	
X02	Date	Input of current date in German format 17.03.23 // TT.MM.JJ	
X04	Time/ date confirmed	<div style="border: 2px solid black; padding: 5px;"> <p><b>Note</b></p> <p><b>When starting the RSM 200 for the first time or after each system restart of the RSM 200 (e.g. power failure without back-up battery), the time and date must be entered again and then confirmed.</b></p> <p><b>Otherwise, a warning message is generated.</b></p> </div>	
X10	Par. Delete arch.	0 - (Default)	
		1 Yes	
X11	Par. Arch. Level	Shows the fill level of the parameter archive	
X12	§Par. Arch. (E) del.	0 - (Default)	
		1 Yes	
X13	§Par. Arch. (E) Level	Shows the fill level of the official parameter archive	
X14	Event Delete arch.	0 - (Default)	
		1 Yes	
X15	Event Arch. Level	Shows the fill level of the event archive	
X17, X18, X19, X20, X21, X22, X23	Measurement archive mode	<b>Period archive</b>	
		X17 interval	0 15 minutes (default)
			1 30 minutes
			2 60 minutes
		X18 delete	0 - (Default)
			1 Yes
		X19 fill level	Shows the fill level of the period archive
		<b>Day archive</b>	
		X20 delete	0 - (Default)
			1 Yes
		X21 fill level	Shows the fill level of the day archive
		<b>Month archive</b>	
		X22 delete	0 - (Default)
			1 Yes
X23 fill level	Shows the fill level of the month archive		

Coordinate	Name	Description						
X24	§Delete all archives	<b>All archives</b> <table border="1"> <tr> <td>X24 delete</td> <td>0</td> <td>- (default)</td> </tr> <tr> <td></td> <td>1</td> <td>Yes</td> </tr> </table>	X24 delete	0	- (default)		1	Yes
X24 delete	0	- (default)						
	1	Yes						

Further information on the archives can be found in *annex D Structure of the archives*.

### 6.8.20. Settings

Coordinate	Name	Description								
Z15	Code Word Input	With entry of this code word, the protected parameters can be changed.  <div style="border: 1px solid black; padding: 5px;"> <p><b>Note</b></p> <p>The codeword is:                    1 2 3 4                      In the parameter archive this is displayed as " * * * * ".</p> </div>								
Z16	Code Word Change	A new password can be defined here.								
Z17	§Device type	Here the firmware for the different RSM 200 variants is defined.								
Z24	Test mode (Display active max.)	For tests, the RSM 200 can be switched to test mode. This is possible in both mains and battery operation. A description is provided in <i>chapter 6.3 Test mode</i> .  <div style="border: 1px solid black; padding: 5px;"> <p><b>Note</b></p> <p>If the RSM 200 is used in battery mode, the test mode should not be used (more frequently). The test mode has an increased energy demand / battery consumption, i.e., if this mode is used more frequently and for a longer period of time, the battery life of 5 years may not be reached.</p> </div> <table border="1"> <tr> <td>0</td> <td>Off</td> </tr> <tr> <td>1</td> <td>1 hour On</td> </tr> <tr> <td>2</td> <td>2 hours On</td> </tr> <tr> <td>3</td> <td>5 hours On</td> </tr> </table>	0	Off	1	1 hour On	2	2 hours On	3	5 hours On
0	Off									
1	1 hour On									
2	2 hours On									
3	5 hours On									
Z25	Volume metering mode	<table border="1"> <tr> <td>0</td> <td>Stop at error</td> </tr> <tr> <td>1</td> <td>Run at error</td> </tr> </table> <p>In the event of an error, the volume counters continue to add up (case 1) or the volume integration is stopped (case 0).</p>	0	Stop at error	1	Run at error				
0	Stop at error									
1	Run at error									

Coordinate	Name	Description						
		<p>In the European sphere of influence, volume integration is generally stopped (case 0).</p> <div style="border: 1px solid black; padding: 5px;"> <p><b>Note</b></p> <p><b>A change of the volume counting mode causes an entry in the event archive.</b></p> </div>						
Z26	Curve linearisation	<p>The RSM 200 allows a characteristic curve correction via a polynomial or a linear interpolation set points. This correction must be activated via <b>coordinate Z26</b>.</p> <table border="1"> <tr> <td>0</td> <td>Off (default)</td> </tr> <tr> <td>1</td> <td>Polynomial</td> </tr> <tr> <td>2</td> <td>Lin. Interpolation</td> </tr> </table> <p>Further information on flow rate calibration can be found in <i>annex C Flow rate calibration</i></p>	0	Off (default)	1	Polynomial	2	Lin. Interpolation
0	Off (default)							
1	Polynomial							
2	Lin. Interpolation							
Z27	§Corr. Mater exp.	<table border="1"> <tr> <td>0</td> <td>Off (default)</td> </tr> <tr> <td>1</td> <td>On (Depending on the temperature, there is a material expansion that causes a change in the cross-section. This is compensated here.)</td> </tr> </table>	0	Off (default)	1	On (Depending on the temperature, there is a material expansion that causes a change in the cross-section. This is compensated here.)		
0	Off (default)							
1	On (Depending on the temperature, there is a material expansion that causes a change in the cross-section. This is compensated here.)							
Z30	§Power supply	<table border="1"> <tr> <td>0</td> <td>Battery mode</td> </tr> <tr> <td>1</td> <td>Mains voltage</td> </tr> </table>	0	Battery mode	1	Mains voltage		
0	Battery mode							
1	Mains voltage							
Z41	Language	<table border="1"> <tr> <td>0</td> <td>German // (Default)</td> </tr> <tr> <td>1</td> <td>English</td> </tr> </table> <div style="border: 1px solid black; padding: 5px;"> <p><b>Note</b></p> <p><b>The language setting of the RSM 200 is independent of that of the RMGView<sup>RSM</sup> software.</b></p> </div>	0	German // (Default)	1	English		
0	German // (Default)							
1	English							


Coordinate	Name	Description
Z50	§Parameter Reset	<p>Resets all parameters to company / default settings.</p> <div style="border: 2px solid black; padding: 5px;"> <p><b>⚠ Caution</b></p> <p>The code word is:                   4 3 2 1 4 3 2 1</p> <p>When this code word is entered, all parameters are reset to their company / default settings. Since these generally do not match your system conditions, damage may be caused. Please use this command only deliberately!</p> </div>

120



## 7. Technical data

### 7.1. General data of the RSM 200

	ATEX design	Non Ex design	
<b>General data</b>			
EU-type examination	DEKRA BVS 23 ATEX E019 X	–	
Ex marking	 II 2 G Ex ia IIC T4 Gb	–	
IECEX marking	IECEX BVS 23.011 X	–	
Ambient temperature	-40 °C ... +60°C (with internal battery pack) -40 °C ... +70°C (without internal battery pack)	-40 °C ... +70 °C	
Protection class	IP 65		
Connection	0,25 ... 1 mm <sup>2</sup> (Wire end ferrule with plastic collar)		
<b>Supply voltage (X5)</b>			
Voltage	11,2 V DC	7 – 30 V DC	
Current	122 mA (with internal battery pack) 322 mA (without internal battery pack)	100 mA	
Power	550 mW (with internal battery pack) 1100 mW (without internal battery pack)	500 mW	
Internal battery pack	6 x lithium cell 3,6 V; in the device, observe battery type: see <i>section 5.1.2 Battery replacement</i>		
Capacity	Ci = negligible	–	
Inductivity	Li = 0,253 mH	–	
<b>Digital outputs DO1...DO4 (Maximum values per output)</b>			
Type	intrinsically safe	Open collector	Namur switching contact
Voltage	Ui = 20 V	U = 3 V ... 30 V	Specification acc. EN 60947-5-6
Current	Ii = 50 mA	I = 50 mA	
Power	Pi = 660 mW	P = 500 mW	
Capacity	Ci = negligible		

Inductivity	Li = negligible			
Switch frequency	max. 5 kHz			
<b>RS485 interface (Supply voltage; X21B, 1-2)</b>				
Type	Variant E	Variant L	Variant E	Variant L
Voltage	U <sub>i</sub> = 11,2 V	U <sub>i</sub> = 3,6 V	U = 5 V ... 30 V	U = 3,0 V ... 3,6 V
Current	I <sub>i</sub> = 135 mA	I <sub>i</sub> = 135 mA	I = 50 mA	I = 50 mA
Power	P <sub>i</sub> = 450 mW	P <sub>i</sub> = 450 mW	P = 500 mW	P = 500 mW
Capacity	C <sub>i</sub> = negligible	C <sub>i</sub> = 145 nF		–
Inductivity	Li = negligible	Li = negligible		–
<b>RS485 interface (Data cable; X21A, 1-2)</b>				
Type	Variant E	Variant L	Variant E	Variant L
Voltage	U <sub>i</sub> = 8,0 V		U = 3,0 V ... 6,0 V	
Current	I <sub>i</sub> = 135 mA		I = 50 mA	
Power	P <sub>i</sub> = 450 mW		P = 450 mW	
Capacity	C <sub>i</sub> = 1488 nF		–	
Inductivity	Li = negligible		–	
Baudrate	9600 - 38400			

## 7.2. Other Inputs

### 7.2.1. Temperature sensor

The temperature sensor is connected at the factory; the Ex-connection values are observed in the process.

#### Elgas EDT 87

Measuring range	-25°C to 70°C
Accuracy*	± 0.2 °C

\*Accuracy (at reference conditions according to IEC 61298-1)

- ≤ ±0,2°K (e.g. ±0,09 % of the measured value in Kelvin)

## 7.2.2. Pressure transducer

The pressure sensor is connected at the factory; the Ex-connection values are observed in the process.

### Elgas EDT 96

123

Measuring range	0,8 bar(a) to 20 bar(a)
Resolution*	≤ ±0.25 %

\*Accuracy (at reference conditions according to IEC 61298-1)  
 ≤ ±0,25 % of the measured value

## 7.3. Outputs

### 7.3.1. Pulse outputs

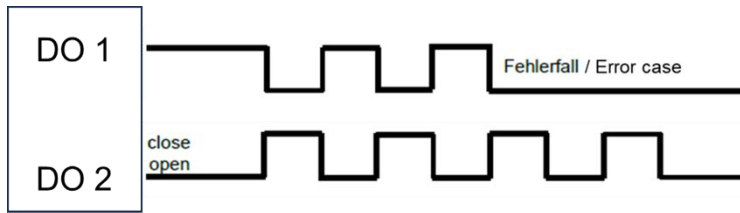
For use of the RSM 200 in explosion-proof areas, the values must be taken from the ATEX certificate.

#### Digital output DO\_1 (galvanically separated)

- Can be switched to NAMUR (according to DIN EN 60947-5 -6) or Open Collector
- Has a galvanically isolated back channel to provide an active NAMUR loop as signal at the  $\mu$ C. Serves to activate the output of encoder telegrams.
- Impulse output up to 5 kHz or UART-Tx signal for encoder telegrams

#### Digital output DO\_2 (galvanically separated)

- Can be switched to NAMUR (according to DIN EN 60947-5 -6) or Open Collector (switches)
- Impulse output up to 5 kHz
- Status signal
- DO 1 is an inverted signal of DO\_2  
 (DO 1 linked to the status signal, stops impulse output in case of error).



### Digital output DO\_3 and DO\_4 (galvanically separated)

- Open Collector
- Status signal
- Impulse output (max. 7 Hz)

### 7.3.2. Data interface

For use of the RSM 200 in explosion-proof areas, the values must be taken from the ATEX certificate.


#### Note

**When using the RS485 interface, the device must be additionally supplied with power.**

**The connection may only be made to a separate, certified, intrinsically safe circuit.**

**The Ex-relevant connection values are specified in the approval and in section 7.1 General data of the RSM 200.**

## 7.4. Technical data of the isolating amplifier type Ex-400

General data	
Supply voltage	9 – 28 V DC
Current consumption	340 mA
Power	1 W
Top-hat rail enclosure dimensions (L x W x H) [mm]	150 x 110 x 50
Gewicht	200 g
Protection class	IP 20 (Top-hat rail module) IP 65 (Wall-mounted in a closed housing)
Ambient temperature	-40 °C ... +60 °C
Mounting	on 35 mm-Top-hat rail or optional wall-mounted housing
Connection	0,25 ... 1 mm <sup>2</sup> (Wire end ferrule with plastic collar)
EU-type examination certificate	TÜV 17 ATEX 207696
Ex marking	 II (2) G [Ex ia Gb] IIC
IECEEx marking	IECEEx TUN 19.0008
Input data (intrinsically safe ia)	
Connection side	Intrinsically safe supply of the gas meter
Intrinsically safe supply X2	
Number	1
U <sub>o</sub>	10,7 V
I <sub>o</sub>	122 mA
P <sub>o</sub>	325 mW
C <sub>o</sub>	750 nF
L <sub>o</sub>	1 mH
Intrinsically safe switch inputs X6	
Number switch inputs	3
Input signals	floating switch contacts, resistor-wired switching contacts
Frequency	1 kHz
U <sub>o</sub>	5,9 V
I <sub>o</sub>	18 mA
P <sub>o</sub>	27 mW

Co	2800 nF
Lo	1 mH
<b>Intrinsically safe serial interface X4</b>	
Number serial interface	1 x RS485
Uo	5,9 V
Io	96 Ma
Po	193 mW
Co	1868 nF
Lo	1 mH
Baudrate	9600 – 38400
<b>Output data (not intrinsically safe)</b>	
Connection side	Connections into the safe area
<b>Switch outputs X5</b>	
Number	3
U max	24 V
I max	50 mA
<b>Serial interface X3</b>	
Number serial interfaces	1 x RS485
U max	8 V
I max	165 mA
Baudrate	9600 - 38400

## 7.5. Overview of materials in use

Name	Material
Housing	Spheroidal graphite cast iron (EN-GJS-18-LT, ASTM A395/A395M)  Cast steel (G20Mn5+QT, ASTM A-352 LCC /A-352 LCB)  Fine-grained steel (P355QH1 DIN EN 10222-4 with 3.1/ AD-A4, W13, W10; ASTM A350 LF2 Class1/ ASME SA350 LF2 Class1)  Aluminium (AISI 7 Mg 0,3; EN AC-42100 KT6; ASME: SB-EN 1706 AC-42100 KT6, (Casting, P-No. 26))
Flow rectifier	Aluminium
Inner measuring cell	Aluminium
Meter head	Aluminium

### Note




**The RSM 200 in nominal size DN50 is made of aluminum or fine-grained steel; no cast material is used for this nominal size.**

## 7.6. Ex certifications and conformities

Ex certificates	
	ATEX 2014/34/EU (BVS 23 ATEX E 019 X) IECEx (IECEx BVS 23.0011X) NEC / CEC
Conformities	
	OIML R 137-1&2:2012 OIML D 11:2013 ISO 17089-1 AGA report No. 9 MID: 2014/32/EU PED: 2014/68/EU EMV: 2014/30/EU
Conversion methods	
	pT – pressure and temperature pTZ – pressure, temperature and real gas factor
Conversion methods	
	Fixed value GERG 88 S GERGS-mod-H <sub>2</sub> AGA 8 Gross method 1 AGA 8 Gross method 2 AGA NX-19-mod. (relative density) AGA NX-19 mod. (standard density) GOST 30319-2



## 8. Event messages

In the display, a present error and a present warning are indicated by a warning triangle  and an arrow , a present hint is only indicated by the arrow. Pressing the key  to the left takes you to the event menu:



**Figure 46: Error message in the display**

In this menu, the error messages are then displayed with error number, information about the present fault and a short description.



There are the following message types:

- E = Error
- W = Warning
- H = Hint

There are the following error messages:

## 8.1. Errors (total overview)

Message type	Error no.	Brief description	Comment
E	1	ERROR_POWER_FAIL	Error when restarting the RSM 200. Contact RMG service.
E	2	ERROR_EEP_HW	EEPROM error Contact RMG service.
E	3	ERROR_CRC_RAM_EEPROM	CRC error of the RAM Contact RMG service
E	4	ERROR_CRC_EEPROM_EEPROM	CRC error of the EEPROM. Contact RMG service
E	5	ERROR_PARAMETER_RANGE	There are parameters outside of the permitted range. Contact RMG service
E	6	ERROR_SAFE_MODE_ON	RSM 200 may not start in the given parameter range. Contact RMG service
E	10	ERROR_PULSE_OUT_MAX	Check the setting in <b>S: Digital Outputs, S05 Pulse value LF</b> ; the highest frequency output may not exceed 7 Hz.
E	11	ERROR_PWM	Analogue output error Contact RMG service
E	12	ERROR_FREQUENCY_OUT_MAX	Check the setting in <b>S: Digital Outputs, S05 Pulse value HF</b> ; the highest frequency output may not exceed 5 kHz.
E	17	ERROR_QM_MIN	Flow rate is for longer than <b>B09 Max.T</b> between <b>B08 Low flow cut-off Qm_II</b> and <b>B05 Flow min Qm_min</b> . Increase the time or change the low flow cut-off.
E	18	ERROR_FLOW_ADJUST_RANGE	The flow rate is above Qm_max. Lower the flow rate or increase <b>B06 Flow rate max Qm_max</b> .
E	19	ERROR_FLOW_SEARCHMODE	A flow rate measurement is impossible or failed. Contact RMG service
E	20	ERROR_PATH_INVALID	The velocity measurement failed on one of the measurement paths. Contact RMG service
E	22	ERROR_TEMP_SENSOR_SN	Check the value of the serial number of the temperature sensor.
E	23	ERROR_TEMP_HW	Temperature measurement error Contact RMG service.
E	24	ERROR_PRESSURE_SENSOR_SN	Check the value of the serial number of the pressure sensor.
E	25	ERROR_PRESSURE_HW	Pressure measurement error Contact RMG service.

Message type	Error no.	Brief description	Comment
E	26	ERROR_GAS_EQUATION	The limit values of the selected gas equation have been exceeded. Check pressure, temperature and/or the gas parameters set in E: Conversion.
E	27	ERROR_TEMP_MIN_MAX	Temperature exceeds min./max. values. Check D04 Temperature min. und D05 Temperature max. settings
E	28	ERROR_PRESSURE_MIN_MAX	Pressure exceeds min./max. values. Check C04 Pressure min. und C05 Pressure max. settings.

### 8.1.1. Effects of errors, warnings, and notes

#### Note

**Warnings and notices have no effect on the meters and error counters.**

**Errors and warnings are stored in the event archive. Notes are also displayed as events but are not saved and are lost after a power failure, for example.**

In the following the errors are listed, under which a counting into the normal or the error counter can take place. With all other errors, counting is stopped completely.

When the following errors occur, a count will continue into the "normal" operating volume counter. Nevertheless, check/eliminate the present error, as it may have an effect on your measurements.

Message type	Error no.	Brief description	Comment
E	10	ERROR_PULSE_OUT_MAX	Check the setting in <b>S: Digital Outputs, S05 Pulse value LF</b> ; the highest frequency output may not exceed 7 Hz.
E	11	ERROR_PWM	Analogue output error Contact RMG service
E	12	ERROR_FREQUENCY_OUT_MAX	Check the setting in <b>S: Digital Outputs, S05 Pulse value HF</b> ; the highest frequency output may not exceed 5 kHz.

Basically, errors affect volume counters for measurement and base conditions equally; the error switches the counting from the "normal" volume counter at measurement conditions to the error volume counter at measurement conditions, then this also occurs analogously for the volume counters at base conditions.

When the following errors occur, a counting is no longer continued in the "normal" volume counter at measurement and base conditions, but the further counting takes place in the error volume counter at measurement respectively base conditions:

Message type	Error no.	Brief description	Comment
E	3	ERROR_CRC_RAM_EEPROM	CRC error of the RAM Contact RMG service
E	17	ERROR_QM_MIN	Flow rate is for longer than <b>B09 Max.T</b> between <b>B08 Low flow cut-off Qm_II</b> and <b>B05 Flow min Qm_min</b> . Increase the time or change the low flow cut-off.
E	18	ERROR_FLOW_ADJUST_RANGE	The flow rate is above Qm_max. Lower the flow rate or increase <b>B06 Flow rate max Qm_max</b> .
E	20	ERROR_PATH_INVALID	The velocity measurement failed on one of the measurement paths. Contact RMG service
E	22	ERROR_TEMP_SENSOR_SN	Check the value of the serial number of the temperature sensor.
E	23	ERROR_TEMP_HW	Temperature measurement error Contact RMG service.
E	24	ERROR_PRESSURE_SENSOR_SN	Check the value of the serial number of the pressure sensor.
E	25	ERROR_PRESSURE_HW	Pressure measurement error Contact RMG service.
E	26	ERROR_GAS_EQUATION	The limit values of the selected gas equation have been exceeded. Check pressure, temperature and/or the gas parameters set in E: Conversion.
E	27	ERROR_TEMP_MIN_MAX	Temperature exceeds min./max. values. Check D04 Temperature min. und D05 Temperature max. settings
E	28	ERROR_PRESSURE_MIN_MAX	Pressure exceeds min./max. values. Check C04 Pressure min. und C05 Pressure max. settings.

## 8.2. Warnings

Message type	Error no.	Brief description	Comment
W	101	WARNING_BATTERY_CAPACITY_LOW	Warning: battery capacity low Change the batteries.
W	102	WARNING_MAINS_SUPPLY_FAIL	Warning: mains power failure Care for a stable power supply.
W	103	WARNING_RTC_INVALID	Time and date must be renewed and confirmed, for example after a power failure. Use the code word for the necessary access.
W	104	WARNING_BOOSTER_POWER_FAIL	Contact RMG service.
W	120	WARNING_FLOW_PATHCOMPENSATION	Warning: compensation active Change the permitted flow rate range.
W	121	WARNING_FLOW_VOG_LIMIT_HIGH	Change the parameter in <b>L: Parameter USM L07 VoG max.</b>
W	122	WARNING_PATH_AGC_HIGH	The necessary amplification is in the limit range of the evaluation possibility. If necessary, change the gas composition.
W	123	WARNING_FLOW_BOTH_PATHS_INVALID	Both measurement paths failed. Increase <b>L: Parameter L03 Size Median Filter.</b>

### 8.3. Notes

Message type	Error no.	Brief description	Comment
H	201	HINT_NEW_FIRMWARE_VERSION	There is a new firmware version
H	202	HINT_METROLOGY_SWITCH_OPEN	The calibration switch is open
H	203	HINT_CODE_WORD_SET	The codeword is set
H	204	HINT_TESTMODE_ON	Testmode is active
H	205	HINT_FLOW_AUTO_FIR	To improve the signal evaluation, the additional, digital filter is automatically active; increased power consumption is to be expected.
H	206	HINT_FLOW_REVERSE	There is a reverse flow.
H	207	HINT_FLOW_AUTO_STACKING	To improve the signal evaluation an auto stacking is automatically activated; increased power consumption is to be expected.
H	208	HINT_SIGNAL_SNR_LOW	The signal/noise ratio is low. A measurement may be difficult. In general, the FIR or the auto stacking is activated.
H	209	HINT_SIGNAL_SNR_WRN	The signal/noise ratio is low. The measurement may fail.
H	210	HINT_SIGNAL_AMP_LOW	Contact RMG service.
H	211	HINT_SIGNAL_AMP_HIGH	Contact RMG service.
H	212	HINT_SIGNAL_TOF_EARLY	Contact RMG service.
H	213	HINT_GASQUALITY_CHANGED	A significant change in the speed of sound indicates a temperature change or a change in the composition of the gas.
H	214	HINT_SIGNAL_TOF_LATE	Contact RMG service.
H	215	HINT_NO_SLEEPING	In battery mode, the device cannot switch to sleep mode, especially if the test mode is activated or the IR read head is not correctly placed.

**Note**

In battery mode, the IR read head should not be "left" on the RSM 200, as (even without communication) this results in increased power consumption with a shortened lifetime.

---

# Annex

## A Counters

### A1 Overview

The gas meter has counters that add up and store the measured flow rates. Counters are available for the following flow rates:

- Measurement flow rate
- Standard flow rate

The flow rate is integrated and summed to the counter reading of the volume totalizer. The following counters are available:

- Standard volume
- Measurement volume
- Standard volume error
- Measurement volume error
- Measurement volume total

The standard volume counter and the (standard volume) error counter are only available when the volume corrector is activated. In the event of a fault, the flow rate is integrated into the fault counters.

The counters are incremented and jump back to zero when their maximum value is reached. The counter reading is stored in the device as a 32-bit integer. It is possible to set the counter resolution via another parameter. This can be varied with the "Resolution exponent".

Only with an exponent of 0, the integer number corresponds to the meter reading in cubic meters or cubic feet. If the exponent is not 0, the correct representation must be calculated from the integer number and the resolution. The following rule applies:

- Negative exponent:  
A negative exponent increases the resolution and adds a decimal point in the display of the counter reading. The result is a decimal number in the volume unit cubic meter or cubic foot.
- Exponent = 0:  
The integer number corresponds to the counter value
- Positive exponent:  
A positive exponent reduces the resolution and inserts one or more zeros in the display of the counter reading on the right.



The following tables show the display of the counters depending on the resolution setting.

		Counter display Counter digits = 9	
Resolution exponent	Resolution	Minimum value in m <sup>3</sup> or ft <sup>3</sup>	Maximum value in m <sup>3</sup> or ft <sup>3</sup>
Saved integer		000 000 000	999 999 999
-3	0.001	000 000.000	999 999.999
-2	0.01	0 000 000.00	9 999 999.99
-1	0.1	00 000 000.0	99 999 999.9
0	1	000 000 000	999 999 999
1	10	0 000 000 000	9 999 999 990
2	100	00 000 000 000	99 999 999 900
3	1000	000 000 000 000	999 999 999 000

**Table 12**

The counter value is always stored as an integer number with 32 bits. Only immediately before the value is shown on the display or in RMGView<sup>RSM</sup>, the value with the correct number of digits is assembled as a string from the counter reading and the resolution exponent. The composite string contains the physical volume in the parameterized volume unit, i.e. in m<sup>3</sup> or cf. The user does not notice anything about the internal integer number, only the correctly composed string is displayed to him.

The unit of the counters is set by selecting the unit system in the device. In the metric system of units, the volume meters use the units cubic meters (m<sup>3</sup>) for measurement and standard flow rate; in the imperial system of units, the units cubic feet (ft<sup>3</sup>).

## A2 Saving the counter data

The data is stored every 30 s on an EEPROM. The data memory can only perform a finite number of write operations, at least about 4 million according to the data sheet. In order to achieve maximum device runtime, the data set is stored alternately in 20 different locations of the EEPROM. The records are secured with a 16-bit checksum, which is checked during readout. If the checksum is invalid, the respective value cannot be used as backup.

## B Modbus

The RSM 200 has a passive RS-485 interface, which means the interface must be supplied with power externally.

138

### Parameterizing the Modbus

#### Modbus activation

H05 RS-485 protocol

0	Off
1	Modbus RTU (default)
2	Modbus ASCII

The **Modbus - ID** is adjusted via **the coordinate H01** (default is 1)

The **Modbus - Register - Offset** (MRO) is entered via **coordinate H02** (default is 1). The MRO applies for read and write operations.

#### Baud rate

H03 Baud rate RS-485 interface

0	2400 Bps
1	9600 Bps
2	19200 Bps
3	38400 Bps (default)

#### Interface parameters

The interface parameters can be adjusted in **coordinate H02**.

H04 RS-485 interface parameters

0	8N1 (default)
1	8E1
2	8O1
3	7N1
4	7E1
5	7O1

**The RSM 200 recognizes the following Modbus commands:**

- (03 Hex) Read Holding Registers
- (06 Hex) Preset Single Register
- (10 Hex) Preset Multiple Regs
- (08 Hex) Subfunction 00 Hex: Return Query data

**RSM 200 Exception Codes**

- 01 Illegal Function
- 02 Illegal Data Address (register not available)
- 03 Illegal Data Value (register not writable or incorrect value)

**Example (Modbus query/response):**

Query:	Send character	
Start Char	:	
Slave Address	<b>01</b>	
Function	<b>03</b>	
Starting Address Hi	<b>07</b>	
Starting Address Lo	<b>CF</b>	2000-1
No. of Points Hi	<b>00</b>	
No. of Points Lo	<b>02</b>	
LRC	<b>24</b>	
carriage return	<b>cr</b>	
line feed	<b>lf</b>	

Response:	Reception signal	
Start Char	:	
Slave Address	<b>01</b>	
Function	<b>03</b>	
Byte Count	<b>04</b>	
Data Hi (Reg 2000)	<b>3F</b>	see below
Data Lo (Reg 2000)	<b>80</b>	see below
Data Hi (Reg 2001)	<b>00</b>	see below
Data Lo (Reg 2001)	<b>00</b>	see below
LRC	<b>39</b>	
carriage return	<b>cr</b>	
line feed	<b>lf</b>	

### Example (Modbus number formats)

Data type	Re-gister	Value	Byte 1	Byte 2	Byte 3	Byte 4	Byte 5	Byte 6	Byte 7	Byte 8	Byte 9	Byte 10
float	2	1.0	0x3f	0x80	0x00	0x00						
Text	5	"90111200"	0x39	0x30	0x31	0x31	0x31	0x32	0x30	0x30	0x00	0x00
int	1	1357	0x05	0x4d								
long	2	698614	0x00	0x0a	0xa8	0xf6						

Refer to the Modbus specifications for further information.

### Characteristics of the RSM 200 Modbus

- Data types (float, text ...) can only be read or written completely

menu16	:	1 Register
int16	:	1 Register
uint16	:	1 Register
int32	:	2 Register
uint32	:	2 Register
float	:	2 Register
string8	:	4 Register
string12	:	6 Register

- A maximum of 125 registers can be read or written (in one command).

- Text fields must have at least one terminating zero (0x00).

- Writing of certain parameters causes internal initialization of the hardware and/or:

- Deletion of intermediate results (pulse output, meter calculation, etc.).
- Therefore, the parameters should only be overwritten as necessary (e.g. meter factor)
- Meter readings are delivered as a uint32 value (without comma)

## Modbus - Register (Firmware vers.: 1.20; Matrix: 127; 2023-09-27)

### Protection

A – Display value (Read-Only)

C – Under codeword protection (Write)

E – Under the Metrological Calibration switch (Write)

N – Without restriction (Write)

141

### Volume / Counters

Coordinate	Name	Modbus register	Protection	Data type	Min.	Max.	Default	Unit
A01	Volume Base	300	A	IS_ICOUNTER32	0.0	9999999.99	0.0	&VolumeUnit
A02	Volume Measure	302	A	IS_ICOUNTER32	0.0	9999999.99	0.0	&VolumeUnit
A03	Volume Base Err	304	A	IS_ICOUNTER32	0.0	9999999.99	0.0	&VolumeUnit
A04	Volume Measure Err	306	A	IS_ICOUNTER32	0.0	9999999.99	0.0	&VolumeUnit
A05	Volume Meas. Total	308	A	IS_ICOUNTER32	0.0	9999999.99	0.0	&VolumeUnit
A20	Resolution Exponent	313	E	IS_INT16	-3	3	0	
A21	Counter Digits	314	E	IS_UINT16	9	9	9	

### Flow rate

Coordinate	Name	Modbus register	Protection	Data type	Min.	Max.	Default	Unit
B01	Flow Rate Base	318	A	IS_FLOAT				&FlowUnit
B02	Flow Rate Meas.	320	A	IS_FLOAT				&FlowUnit
B05	Flow Rate min.	521	E	IS_FLOAT	0.0	250.0	4.0	&FlowUnit
B06	Flow Rate max.	523	E	IS_FLOAT	16.0	2500.0	400.0	&FlowUnit
B07	Flow Rate Peak	525	E	IS_FLOAT				&FlowUnit
B08	Low Flow Cut-Off	527	E	IS_FLOAT	0.0	250.0	1.0	&FlowUnit
B09	Max.T>=QII+<Q min	529	E	IS_UINT16	0	10000	10	s
B10	Coefficient A-2	530	E	IS_FLOAT	-100.0	100.0	0.0	
B11	Coefficient A-1	532	E	IS_FLOAT	-100.0	100.0	0.0	
B12	Coefficient A0	534	E	IS_FLOAT	-100.0	100.0	0.0	
B13	Coefficient A1	536	E	IS_FLOAT	-100.0	100.0	0.0	

Coordinate	Name	Modbus register	Protection	Data type	Min.	Max.	Default	Unit
B14	Coefficient A2	538	E	IS_FLOAT	-100.0	100.0	0.0	
B16	System Status	341	A	IS_MENU				
B17	Transition Flow	543	E	IS_FLOAT	0.0	250.0	16.00	&FlowUnit
B18	Flow Rate 1	860	E	IS_FLOAT				&FlowUnit
B19	Error 1	862	E	IS_FLOAT				
B20	Flow Rate 2	864	E	IS_FLOAT				&FlowUnit
B21	Error 2	866	E	IS_FLOAT				
B22	Flow Rate 3	868	E	IS_FLOAT				&FlowUnit
B23	Error 3	870	E	IS_FLOAT				
B24	Flow Rate 4	872	E	IS_FLOAT				&FlowUnit
B25	Error 4	874	E	IS_FLOAT				
B26	Flow Rate 5	876	E	IS_FLOAT				&FlowUnit
B27	Error 5	878	E	IS_FLOAT				
B28	Flow Rate 6	880	E	IS_FLOAT				&FlowUnit
B29	Error 6	882	E	IS_FLOAT				
B30	Flow Rate 7	884	E	IS_FLOAT				&FlowUnit
B31	Error 7	886	E	IS_FLOAT				
B32	Flow Rate 8	888	E	IS_FLOAT				&FlowUnit
B33	Error 8	890	E	IS_FLOAT				
B34	Flow Rate 9	892	E	IS_FLOAT				&FlowUnit
B35	Error 9	894	E	IS_FLOAT				
B36	Flow Rate 10	896	E	IS_FLOAT				&FlowUnit
B37	Error 10	898	E	IS_FLOAT				
B38	Flow Rate 11	900	E	IS_FLOAT				&FlowUnit
B39	Error 11	902	E	IS_FLOAT				
B40	Flow Rate 12	904	E	IS_FLOAT				&FlowUnit
B41	Error 12	906	E	IS_FLOAT				
B42	Alpha Material	914	E	IS_FLOAT			26.3E-6	&1/Kelvin
B43	T Calibration	916	E	IS_FLOAT	-40	80	21	&TemperatureDegree Unit
B44	Qmu-Factor Kv	918	E	IS_FLOAT	0	10	1	

## Pressure

Coordinate	Name	Modbus register	Protection	Data type	Min.	Max.	Default	Unit
C01	Pressure	326	A	IS_FLOAT				&PressureUnit
C02	Pressure Mode	555	E	IS_MENU			0	
C03	Pressure Default	556	C	IS_FLOAT	0.8	20.0	1.0	&PressureUnit
C04	Pressure Minimum	558	E	IS_FLOAT	0.8	2.0	1.0	&PressureUnit
C05	Pressure Maximum	560	E	IS_FLOAT	2.0	20.0	20.0	&PressureUnit
C08	Pressure Offset	562	E	IS_FLOAT	-0.5	0.5	0.0	&PressureAbsoluteUnit
C09	Pressure Slope	564	E	IS_FLOAT	0.8	1.2	1.0	
C13	Atmospheric Press.	631	E	IS_FLOAT	0.5	1.5	1.0	&PressureAbsoluteUnit

## Temperature

Coordinate	Name	Modbus register	Protection	Data type	Min.	Max.	Default	Unit
D01	Temperature	324	A	IS_FLOAT				&TemperatureDegreeUnit
D02	Temperature Mode	587	E	IS_MENU			0	
D03	Temp. Default	588	E	IS_FLOAT	-40.0	80.0	20.0	&TemperatureDegreeUnit
D04	Temperature Min.	590	E	IS_FLOAT	-40.0	80.0	-20.0	&TemperatureDegreeUnit
D05	Temperature Max.	592	E	IS_FLOAT	-40.0	80.0	65.0	&TemperatureDegreeUnit
D07	Temperature Offset	823	E	IS_FLOAT	-5.0	5.0	0.0	&TemperatureDeltaUnit

## Analysis

Coordinate	Name	Modbus register	Protection	Data type	Min.	Max.	Default	Unit
E01	Conversion Factor	328	A	IS_FLOAT				
E02	Compr.F. (Zm/Zb)	633	A	IS_FLOAT	0.0	1.0	1.0	
E03	Compr.F.Meas. (Zm)	635	A	IS_FLOAT				
E04	Compr.F.Base (Zb)	637	A	IS_FLOAT				
E05	Calc. Method	639	E	IS_MENU			0	

Coordinate	Name	Modbus register	Protection	Data type	Min.	Max.	Default	Unit
E06	Compr. Factor Def.	640	C	IS_FLOAT	0.6	1.0	1.0	
E07	Calorific Value	642	C	IS_FLOAT	7.0	15.0	11.0	MJ/m3
E08	Standard Density	644	C	IS_FLOAT	0.6	1.5	0.8	kg/m3
E09	Relative Density	646	C	IS_FLOAT	0.0	100.0	1.0	
E10	Carbon Dioxide	648	C	IS_FLOAT	0.0	10.0	0.0	Mol-%
E11	Nitrogen	650	C	IS_FLOAT	0.0	15.0	0.0	Mol-%
E12	Hydrogen	652	C	IS_FLOAT	0.0	30.0	0.0	Mol-%
E20	Base Pressure	654	A	IS_FLOAT				&PressureAbsoluteUnit
E21	Base Temperature	658	A	IS_FLOAT				&Temperature-Degree-Unit
E22	Base Temp. Cal. Fac.	656	A	IS_FLOAT			4	&Temperature-Degree-Unit
E23	Reference Conditions	660	C	IS_MENU				
E24	T/P Sample Time	661	C	IS_UINT16	1	30	30	s

### Current output

Coordinate	Name	Modbus register	Protection	Data type	Min.	Max.	Default	Unit
F01	Current	330	A	IS_FLOAT				mA
F02	Current Mode	5400	N	IS_MENU				
F03	Current Souce	5401	N	IS_MENU				
F04	Phys. min. Value	5402	N	IS_FLOAT	-40.0	50000.0	1.0	&CurrentOutput-ModuleUnit
F05	Phys. max. Value	5404	N	IS_FLOAT	-40.0	50000.0	20.0	&CurrentOutput-ModuleUnit
F06	Current Default	5406	N	IS_FLOAT	0.0	24.0	12.0	mA
F07	Current Damping	5408	N	IS_FLOAT	0.0	1.0	0.7	

### Information

Coordinate	Name	Modbus register	Protection	Data type	Min.	Max.	Default	Unit
G01	Year	675	E	IS_UINT16	2023	2099	2023	
G02	Software Version	676	A	IS_FLOAT				Rev
G04	Serial Number	680	E	IS_UINT32	0	99999999	0	
G05	Firmware CRC	682	A	IS_HEX16				Hex



Coordinate	Name	Modbus register	Protection	Data type	Min.	Max.	Default	Unit
G06	Metering Point	1340	N	IS_STRING12				
G07	Device Type	815	N	IS_STRING12			ABCD1234	
G08	MCU Temperature	801	A	IS_INT16				
G09	LCD Refresh Time	802	N	IS_MENU				
G10	Pressure Base	693	A	IS_FLOAT	0.0	100.0	1.0	&PressureAbsoluteUnit
G11	Pressure Min.	685	A	IS_FLOAT	0.0	100.0	0.8	&PressureUnit
G12	Pressure Max	687	A	IS_FLOAT	0.0	100.0	10.0	&PressureUnit
G13	Pressure Sensor SN	689	E	IS_UINT32	0	4294967295		
G14	Temperature Base	695	A	IS_FLOAT	0.0	300.0	273.15	&TemperatureDegreeUnit
G15	Temperature Min.	1695	A	IS_FLOAT	-50.0	100.0	-25.0	&TemperatureDegreeUnit
G16	Temperature Max.	1697	A	IS_FLOAT	-50.0	100.0	70.0	&TemperatureDegreeUnit
G17	Temp. Sensor SN	697	E	IS_UINT32	0	4294967295		
G18	Electronic SN	699	E	IS_UINT32			99999999	
G19	US-Sensors SN	787	C	IS_UINT32				
G20	Version of Matrix	200	A	IS_UINT16				
G23	Batt. new dd.mm.yy	705	A	IS_DATE			010100	
G24	Remaining Batt. Cap	790	A	IS_UINT16	0	100	100	%
G25	Battery Change	791	C	IS_MENU			0	
G27	Battery Capacity	794	E	IS_UINT16				Ah
G28	Operating Mode	783	E	IS_MENU			0	
G29	Meter Size	785	E	IS_MENU				
G30	Pressure Class	796	E	IS_MENU				
G31	Flange Type	786	E	IS_MENU				
G32	Cross.Manufact.ID	762	A	IS_STRING16				

### RS-485 communication

Coordinate	Name	Modbus register	Protection	Data type	Min.	Max.	Default	Unit
H01	Modbus ID	5503	N	IS_UINT16	1	247	1	
H02	Modbus Reg.Offset	5504	N	IS_UINT16	0	10000	1	
H03	Onboard Baudrate	5500	N	IS_MENU			1	Bps
H04	Onboard Parameter	5501	N	IS_MENU			0	
H05	Onboard Protocol	5502	N	IS_MENU			1	
H06	Opt. Baudrate	5505	N	IS_MENU			3	Bps
H07	Opt. Parameter	5506	N	IS_UINT16			0	
H08	Opt. Protocol	5507	N	IS_UINT16			1	
H09	Module Baudrate	5508	N	IS_MENU			1	Bps
H10	Module Parameter	5509	N	IS_MENU			0	
H11	Module Protocol	5510	N	IS_UINT16			1	

### USM measured values

Coordinate	Name	Modbus register	Protection	Data type	Min.	Max.	Default	Unit
I02	Gas Velocity	346	A	IS_FLOAT				&VelocityUnit
I03	Speed of Sound	348	A	IS_FLOAT				&VelocityUnit
I04	Flow Direction	345	A	IS_MENU			1	
I05	P1/P2 Velocity	354	A	IS_FLOAT				
I07	P1/P2 SoS.	356	A	IS_FLOAT				
I09	P1 Acceptance Rate	364	A	IS_UINT16				%
I11	P1 Gas Velocity	366	A	IS_FLOAT				&VelocityUnit
I12	P1 SoS	368	A	IS_FLOAT				&VelocityUnit
I13	P2 Acceptance Rate	370	A	IS_UINT16				%
I15	P2 Gas Velocity	374	A	IS_FLOAT				&VelocityUnit
I16	P2 SoS	376	A	IS_FLOAT				&VelocityUnit

### Measurement path 1 Diagnosis

Coordinate	Name	Modbus register	Protection	Data type	Min.	Max.	Default	Unit
J11	P1 BA SNR	1018	A	IS_FLOAT				dB
J12	P1 AB SNR	1020	A	IS_FLOAT				dB
J15	P1 BA AGC Actual	1026	A	IS_FLOAT				dB
J16	P1 AB AGC Actual	1028	A	IS_FLOAT				dB

**Measurement path 2 Diagnosis**

Coordinate	Name	Modbus register	Protection	Data type	Min.	Max.	Default	Unit
K11	P2 BA SNR	1118	A	IS_FLOAT				dB
K12	P2 AB SNR	1120	A	IS_FLOAT				dB
K15	P2 BA AGC Actual	1126	A	IS_FLOAT				dB
K16	P2 AB AGC Actual	1128	A	IS_FLOAT				dB

147

**USM Parameter**

Coordinate	Name	Modbus register	Protection	Data type	Min.	Max.	Default	Unit
L01	Smoothing Filter	2000	C	IS_FLOAT	0.0	1.0	1.0	
L02	Meas. Rate	2002	E	IS_UINT16	1.0	5.0	2.0	/s
L03	Size Median Filter	2003	C	IS_UINT16	1.0	20.0	10.0	
L05	Warning AGC	2006	N	IS_FLOAT	60.0	80.0	70.0	dB
L06	Warning SNR	2008	E	IS_FLOAT	5.0	40.0	15.0	dB
L07	Warning VoG max	2010	E	IS_FLOAT	0.0	50.0	35.	&VelocityUnit
L08	Min Err Search	2012	E	IS_UINT16	10.0	90.0	20.0	%
L09	Max Err Measure	2013	E	IS_UINT16	10.0	90.0	50.0	%
L10	Limit SNR min	2014	E	IS_FLOAT	5.0	40.0	10.0	dB
L11	Limit Signal min	2016	E	IS_FLOAT	0.0	100.0	10.0	%
L12	Limit Signal max	2018	E	IS_FLOAT	0.0	100.0	95.0	%
L13	AGC Mode	2020	E	IS_MENU				
L14	AGC Initvalue	2021	E	IS_FLOAT	0.0	80.0	50.0	dB
L15	SignalMax Setpoint	2023	E	IS_FLOAT	0.0	100.0	70.0	%V
L18	Transmit Freq.	2029	E	IS_UNIT32	10	500	200	kHz
L19	Transmit Pulses	2031	E	IS_UINT16	2	5	3	
L20	Receive Pulses	2032	E	IS_UINT16	2	10	3	
L21	RxMinAmplitude	2033	E	IS_UINT16	5	30	15	%
L22	ToF Mode	2034	E	IS_MENU				
L24	BP f_low	2038	E	IS_UINT16	0	500	160	kHz
L25	BP f_high	2039	E	IS_UINT16	0	500	240	kHz
L27	HinkleyAlpha	2040	E	IS_FLOAT	1.0	10.0	2.0	

### Adjust USM

Coordinate	Name	Modbus register	Protection	Data type	Min.	Max.	Default	Unit
M01	Inner Diameter	5000	E	IS_FLOAT	0.0	500	58.0	&LengthUnit
M02	P1 Length	5002	E	IS_FLOAT	0.0	1000	188.5	&LengthUnit
M03	P1 Angle	5004	E	IS_FLOAT	0.0	89	76	°
M04	P1 Length Sensor A	5006	E	IS_FLOAT	0.0	50	0.0	&LengthUnit
M05	P1 Length Sensor B	5008	E	IS_FLOAT	0.0	50	0.0	&LengthUnit
M06	P2 Length	5010	E	IS_FLOAT	0.0	1000	185.5	&LengthUnit
M07	P2 Angle	5012	E	IS_FLOAT	0.0	89	76	°
M08	P2 Length Sensor A	5014	E	IS_FLOAT	0.0	50	0.0	&LengthUnit
M09	P2 Length Sensor B	5016	E	IS_FLOAT	0.0	50	0.0	&LengthUnit
M10	P1 TW	5018	E	IS_FLOAT	-100	100	0.0	μs
M11	P1 Delta T Offset	5020	E	IS_FLOAT	-10	10	0.0	μs
M12	P2 TW	5022	E	IS_FLOAT	-100	100	0.0	μs
M13	P2 Delta T Offset	5024	E	IS_FLOAT	-10	10	0.0	μs

### Reynolds correction

Coordinate	Name	Modbus register	Protection	Data type	Min.	Max.	Default	Unit
N01	Reynolds Number	350	A	IS_FLOAT				
N02	Reyn. No. Minimum	5100	E	IS_FLOAT	10	10000	100	
N05	Reynolds Correction	5102	E	IS_MENU			1	
N06	Detected Medium	5103	A	IS_MENU			0.0	
N07	Corr.-Coeff. -2	5104	E	IS_FLOAT			0.0	
N08	Corr.-Coeff. -1	5106	E	IS_FLOAT			0.0	
N09	Corr.-Coeff. 0	5108	E	IS_FLOAT			0.0	
N10	Corr.-Coeff. 1	5110	E	IS_FLOAT			0.0	
N11	Corr.-Coeff. 2	5112	E	IS_FLOAT			0.0	
N12	MF-Coeff. A2	5114	E	IS_FLOAT	0.0	0,005	0.00191935	
N13	MF-Coeff. A1	5116	E	IS_FLOAT	-1.0	0.0	-0.604784	
N14	MF-Coeff. A0	5118	E	IS_FLOAT	150	250	195.16	
N15	T(c)-Coeff. B2	5120	E	IS_FLOAT	0.0	0,01	0.00286	
N16	T(c)-Coeff. B1	5122	E	IS_FLOAT	-5	0.0	-1.078	
N17	T(c)-Coeff. B0	5124	E	IS_FLOAT	-1000	0.0	-61.69	
N19	Correction function	5128	E	IS_MENU				

**Signal search**

Coordinate	Name	Modbus register	Protection	Data type	Min.	Max.	Default	Unit
R01	SoS min	5200	A	IS_FLOAT				&VelocityUnit
R02	SoS max	5202	A	IS_FLOAT				&VelocityUnit
R03	Expected SOS	5204	C	IS_FLOAT	250.	900.	342.	&VelocityUnit
R05	Size Search Win	5207	E	IS_UINT16	128	1536	1024	
R06	Size Meas. Win	5208	E	IS_UINT16	128	1536	256	
R07	ADC Resolution	5209	E	IS_MENU			3	Bit
R08	Time Resolution	5210	E	IS_MENU			1	ns

149

**Digital outputs**

Coordinate	Name	Modbus register	Protection	Data type	Min.	Max.	Default	Unit
S01	Dig. Out 1 Mode	5300	E	IS_MENU			0	
S02	Dig. Out 2 Mode	5301	E	IS_MENU			0	
S03	Dig. Out 3 Mode	5302	E	IS_MENU			0	
S04	Dig. Out 4 Mode	5303	E	IS_MENU			0	
S05	LF-Channel A Mode	5328	E	IS_MENU			0	
S06	LF-Channel B Mode	5329	E	IS_MENU			0	
S07	Pulse Value LF	5304	E	IS_FLOAT	0,01	100	10	&ImpulseUnit
S08	Pulse Width Max LF	5306	E	IS_MENU			0	ms
S09	HF Mode	5307	E	IS_MENU			0	
S10	Pulse Value HF	5308	E	IS_FLOAT	1.0	999000.0	36000.0	&ImpulseUnit
S11	Frequency(Qmax) HF	5310	A	IS_FLOAT				Hz
S12	Test Frequency HF	5312	N	IS_FLOAT	0.00	5000.0	2000.0	Hz
S13	F Max HF Hardware	5314	E	IS_FLOAT	0.00	5000.0	5000.0	Hz
S14	Flow Rate	5316	A	IS_FLOAT				&FlowUnit
S15	Frequ. nominal HF	5318	A	IS_FLOAT				Hz
S16	Frequ. actual HF	5320	A	IS_FLOAT				Hz
S17	Freq. Error HF	5322	A	IS_FLOAT				%
S18	Enco. Tel. Dist.	5324	E	IS_UINT16	500	30000	500	ms
S19	Enco. B Tel. occ.	5325	E	IS_UINT16	2	100	2	ms
S20	Enco. CRC Start	5326	E	IS_UINT16			1	
S21	Enco. Tel1. delay	5327	E	IS_UINT16	50	30000	500	ms

### RnD Parameters

Coordinate	Name	Modbus-register	Protection	Data type	Min.	Max.	Default	Unit
T01	tSer	3200	E	IS_FLOAT	1.0	10	1.0	µs
T02	MuxOn	3202	E	IS_FLOAT	1.0	100000	200	µs
T03	BoosterOn	3204	E	IS_FLOAT	1.0	100000	2000	µs
T04	AMPOn	3206	E	IS_FLOAT	1.0	100000	1500	µs
T05	TxSignal	3208	E	IS_FLOAT	1.0	100000	10	µs
T06	MuxOff	3210	E	IS_FLOAT	1.0	100000	1.0	µs
T19	Chopper Mode	3230	E	IS_MENU				
T21	max. MuxOn delay	3232	E	IS_FLOAT				
T22	Mux On Long Limit	3234	E	IS_FLOAT				

### Unit system

Coordinate	Name	Modbus register	Protection	Data type	Min.	Max.	Default	Unit
U01	System of Units	3300	E	IS_MENU			0	
U02	Volume Unit	3301	E	IS_MENU				
U03	Flow Unit	3302	E	IS_MENU				
U04	Impulse Unit	3303	E	IS_MENU				
U05	Temperature Unit	3304	E	IS_MENU				
U06	Temp. absolute Unit	3305	E	IS_MENU				
U07	Pressure Unit	3306	E	IS_MENU				
U08	Pressure Unit abs.	3307	E	IS_MENU				
U09	Length Unit	3308	E	IS_MENU				
U10	Velocity Unit	3309	E	IS_MENU				
U11	Density Unit	3310	E	IS_MENU				
U12	Calorific Unit	3311	E	IS_MENU				
U13	Unit Curr. Outp.	3312	A	IS_MENU				

### F-instance register addresses Nameplate

Coordinate	Name	Modbus register	Protection	Data type	Min.	Max.	Default	Unit
V01	ISO_Manufacturer	33792	A	IS_STRING16			0	
V02	ISO_Type	33800	A	IS_STRING16				
V03	ISO_SerialNo	33808	A	IS_STRING16				

Coordinate	Name	Modbus register	Protection	Data type	Min.	Max.	Default	Unit
V04	ISO_Year	33816	A	IS_STRING16				
V05	ISO_Version	33814	A	IS_STRING16				
V06	ISO_CRC	33832	A	IS_STRING32				
V07	ISO_Unit	33848	A	IS_UINT32				
V08	ISO_Func	33850	A	IS_UINT32				
V09	ISO_FlowMin	33852	A	IS_FLOAT				
V10	ISO_FlowMax	33854	A	IS_FLOAT				
V11	ISO_MinOP	33856	A	IS_FLOAT				
V12	ISO_MaxOP	33858	A	IS_FLOAT				
V13	ISO_MinT	33860	A	IS_FLOAT				
V14	ISO_MaxT	33862	A	IS_FLOAT				

### F-instance register addresses Values

Coordinate	Name	Modbus register	Protection	Data type	Min.	Max.	Default	Unit
W01	ISO_FlowRate	32768	A	IS_FLOAT			0	
W02	ISO_VoG	32770	A	IS_FLOAT				
W03	ISO_SoS	32772	A	IS_FLOAT				
W04	ISO_Cnt_total_pos	32774	A	IS_UINT32				
W05	ISO_Cnt_total_neg	32776	A	IS_UINT32				
W06	ISO_Cnt_pos	32778	A	IS_UINT32				
W07	ISO_Cnt_neg	32780	A	IS_UINT32				
W08	ISO_Cnt_err_pos	32782	A	IS_UINT32				
W09	ISO_Cnt_err_neg	32784	A	IS_UINT32				
W10	ISO_Cnt_resolution	32786	A	IS_INT32				
W11	ISO_Flag_qt	32788	A	IS_UINT32				
W12	ISO_Signal_AR	32790	A	IS_UINT32				
W13	ISO_ErrStatus	32792	A	IS_UINT32				
W14	ISO_PathNo	32794	A	IS_UINT32				
W15	ISO_devSoS1	32796	A	IS_FLOAT				
W16	ISO_devSoS2	32798	A	IS_FLOAT				
W65	ISO_P1_VoG	32896	A	IS_FLOAT				
W66	ISO_P1_SoS	32898	A	IS_FLOAT				
W67	ISO_P1_Signal_AR	32900	A	IS_FLOAT				

Coordinate	Name	Modbus register	Protection	Data type	Min.	Max.	Default	Unit
W68	ISO_P1_SNR_AB	32902	A	IS_FLOAT				
W69	ISO_P1_SNR_BA	32904	A	IS_FLOAT				
W70	ISO_P1_AGC_AB	32906	A	IS_FLOAT				
W71	ISO_P1_AGC_BA	32908	A	IS_FLOAT				
W72	ISO_P1_dummy	32910	A	IS_FLOAT				
W73	ISO_P2_VoG	32912	A	IS_FLOAT				
W74	ISO_P2_SoS	32914	A	IS_FLOAT				
W75	ISO_P2_Signal_AR	32916	A	IS_FLOAT				
W76	ISO_P2_SNR_AB	32918	A	IS_FLOAT				
W77	ISO_P2_SNR_BA	32920	A	IS_FLOAT				
W78	ISO_P2_AGC_AB	32922	A	IS_FLOAT				
W79	ISO_P2_AGC_BA	32924	A	IS_FLOAT				
W80	ISO_P2_dummy	32926	A	IS_FLOAT				

### Archive

Coordinate	Name	Modbus register	Protection	Data type	Min.	Max.	Default	Unit
X01	Time (hh:mm:ss)	714	E	IS_TIME				h
X02	Date (dd.mm.yy)	717	E	IS_DATE				
X04	Time/Date confirm	776	C	IS_MENU			0	
X10	Del. Par. Arch.	722	E	IS_MENU			0	
X11	Level Par. Arch.	723	A	IS_UINT16			0	%
X12	Del. Par. Arch.(E)	724	E	IS_MENU			0	
X13	Level Par.Arch.(E)	725	A	IS_UINT16			0	%
X14	Del. Event Archive	726	E	IS_MENU			0	
X15	Level Event Arch.	727	A	IS_UINT16			0	%
X17	Interv. Per. Arch.	729	E	IS_MENU			2	
X18	Del. Per. Arch.	730	E	IS_MENU			0	
X19	Level Per. Arch.	731	A	IS_MENU16			0	%
X20	Del. Day Archive	732	E	IS_MENU				
X21	Level Day Archive	733	A	IS_UINT16			0	%
X22	Delete Month Arch.	734	E	IS_MENU			0	
X23	Level Month Arch.	735	A	IS_UINT16			0	%
X24	Del. all Archives	812	E	IS_MENU			0	



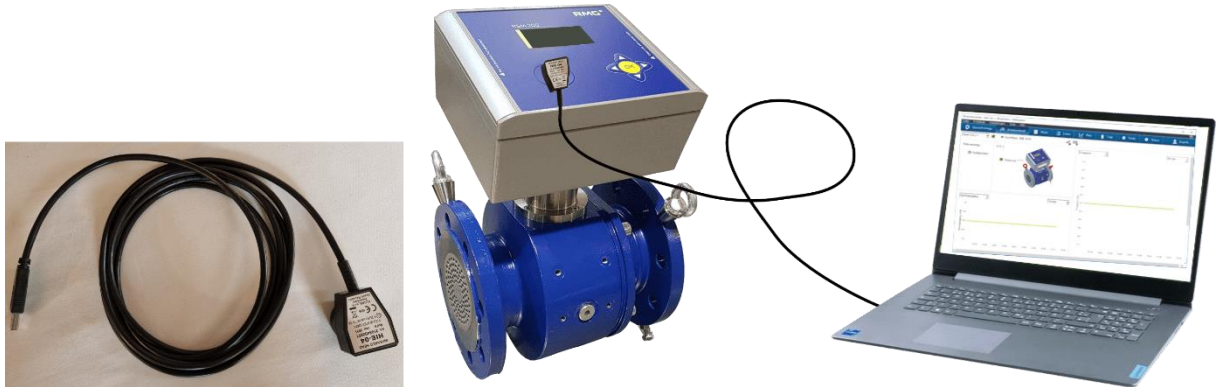
**Settings**

Coordinate	Name	Modbus register	Protection	Data type	Min.	Max.	Default	Unit
Z15	CodeWord	777	N	IS_CODE16	0	9999	0	
Z16	CodeWordInput	778	C	IS_CODE16	1	9999	1234	
Z17	DeviceType	779	E	IS_MENU				
Z24	TestMode	780	C	IS_MENU				
Z25	VolumeMode	781	E	IS_MENU				
Z26	CurveLinearizationQ	782	E	IS_MENU				
Z27	Corr_Alpha_Material	784	E	IS_MENU				
Z30	PowerSupplyMode	813	E	IS_MENU				
Z41	Language	814	N	IS_MENU				
Z50	Parameters Reset	22	E	IS_UINT32				



## C Flow rate calibration

Establish a data connection to the meter using the RMGView<sup>RSM</sup> software via the infrared interface. Please make sure that the cable of the IR head points vertically downwards.

154



**Figure 47: Data link with RMGView<sup>RSM</sup>**

Log in to the measuring device as "configurator"; this can be selected via the button . Please enter the password "RMGRSM-C", confirm it and the appearance of the button will change to .

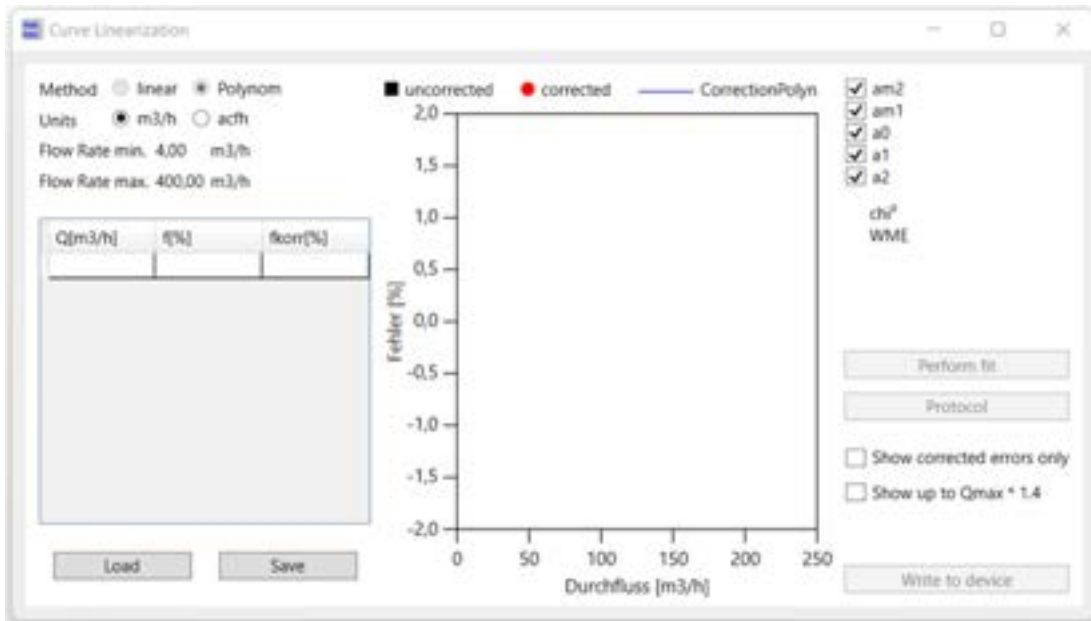
In addition, the calibration switch must be pressed, see *Figure 16: Position of the calibration switch*.

Pressing the "Tools" button in the top line takes you to the "Characteristic curve correction" menu. Use this tool to calibrate the meter.



**Figure 48: Characteristic curve correction tool**

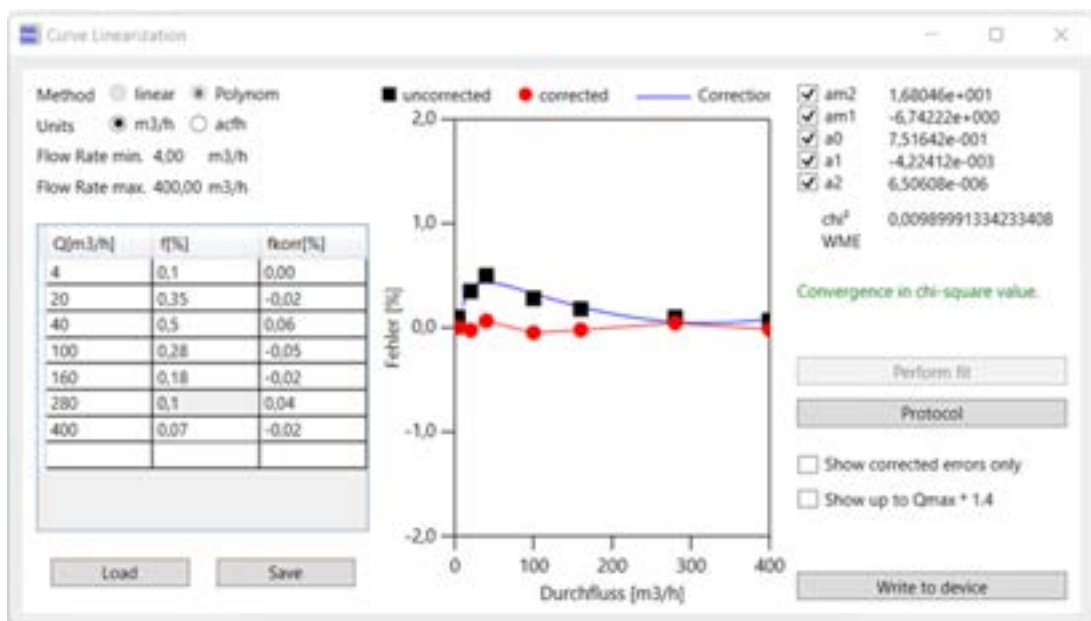
The "Characteristic curve correction" tool is then displayed.



**Figure 49: Characteristic curve correction tool**

Under Q [m<sup>3</sup>/h], enter the calibration points at different flow rates (flow order: increasing, no arbitrary order) and under f [%], enter the relative deviations (f[%]) from the reference at these flow rates.

$$f[\%] = \frac{Q(\text{gemessen}) - Q(\text{Referenz})}{Q(\text{Referenz})} \cdot 100\%$$



**Figure 50: Value input in the characteristic curve correction tool**

With "Perform Fit" (in the middle of the right side) the coefficients of the calibration polynomial  $am_2$ ,  $am_1$ ,  $am_0$ ,  $a_1$  and  $a_2$  are calculated and displayed. In addition, a residual error is also indicated. With "Transfer to instrument" (in the lower right corner) these coefficients are transferred to the instrument.

Coord	Name	Value	Unit
B-01	\$Flow Rate Base	355,557	m3/h
B-02	\$Flow Rate Meas.	392,296	m3/h
B-05	\$Flow Rate min.	4,00	m3/h
B-06	\$Flow Rate max.	400,00	m3/h
B-08	\$Low Flow Cut-Off	1,00	m3/h
B-09	\$Max.T > =Qll+ < Qmin	10	s
B-10	\$Coefficient A-2	16,80458	
B-11	\$Coefficient A-1	-6,742224	
B-12	\$Coefficient A0	0,751642	
B-13	\$Coefficient A1	-0,004224119	
B-14	\$Coefficient A2	6,506084E-06	
B-16	System Status	Okay	
B-17	\$Transition Flow	16,0	m3/h
B-44	\$Qmu-Factor Kv	1,000	

**Figure 51: Transfer of the calibrated curve coefficients**

The polynomial coefficients are then written to the B Flow rate menu in coordinates B10 to B14.

In the **Z Settings** menu with **Z26 Characteristic corr.** this correction can be applied if "On" is selected.

**Note**

**Outside  $Q_{min}$  to  $Q_{max}$ , the last calibration value is frozen.**

### Flow rate sequences

Regardless of the sample gas used, the tests must be performed with (at least) the following test flow rates for each test pressure:

ISO 17089-1, OIML R137-1, directive 2014/32/EU, MI002 (MID) For the measuring range 1:20 $Q_{\min}$ matches the test point 0.05	Flow rate values acc. To AGA 9
	$Q_{\min}$
$Q_{\min}$	$0.025 \times Q_{\max}$
$0.05 \times Q_{\max}$	$0.05 \times Q_{\max}$
$0.1 \times Q_{\max}$	$0.1 \times Q_{\max}$
$0.25 \times Q_{\max}$	$0.25 \times Q_{\max}$
$0.4 \times Q_{\max}$	$0.4 \times Q_{\max}$
$0.7 \times Q_{\max}$	$0.7 \times Q_{\max}$
$Q_{\max}$	

**Table 13**
**Comment:**

It is recommended to add additional test flow rates below  $0.05 \times Q_{\max}$  for measuring ranges larger than 1:50 to be calibrated, e.g.

1:100       $0,02 \times Q_{\max}$

1:150       $0,01 \times Q_{\max},$

..

The minimum measurement time for each test point shall be 100 s and shall be consistent with the minimum measurement time requirements used in uncertainty testing of the test equipment.

The measurement of a test flow rate should be repeated at least 3 times. These three test results must not show a trend of measurement deviation in a direction that would cause a difference of

$$|f_n - f_{n-2}| > 0,15\% \text{ for } Q \geq Q_t$$

$$\text{or } |f_n - f_{n-2}| > 0,30\% \text{ für } Q < Q_t$$

At least one additional test point is required until three consecutive measurements at one measurement point meet this requirement.

If the pulse output is used for testing, it must be ensured that the number of measured pulses during a test point reaches a resolution of the measured value of at least

0.05% for test flow rates  $> Q_t$ , or

0.1% for test flow rates  $< Q_t$ ,

This can be achieved by extending the measurement time or by specifying a suitable pulse factor on the meter before the test.

The maximum permissible deviations for all test results are derived from the transition flow rate  $Q_t$  applicable to the individual counter:

$Q_{\min} \leq q < Q_t$	$\pm 2.0 \%$	
$Q_t \leq q \leq Q_{\max}$	$\pm 1.0 \%$	
$Q_t$	$Q_{\min}/Q_{\max} = 1:20$	$\leq 0.20 Q_{\max}$
	$Q_{\min}/Q_{\max} = 1:30$	$\leq 0.15 Q_{\max}$
	$Q_{\min}/Q_{\max} = 1:50$	$\leq 0.10 Q_{\max}$

### Note

**Inform the manufacturer if the RSM 200 under test is not within the MPE. If conformity cannot be proven, the device must be marked**

## Data recording during the test

The measurement and diagnostic data of the RSM 200 are transmitted via the infrared interface during the test and automatically recorded by the RMGView<sup>RSM</sup> software. After completing all measurement repetitions for a test flow rate, enter the mean error into the characteristic curve correction tool of the RMGView<sup>RSM</sup> software.

Click "Enter" to enter a new flow rate value. Repeat all of the above steps until you have recorded at least seven different flow rate values.

## Counter setting and error correction

A flow rate dependent polynomial is applied in the meter to correct the characteristic curve.

$$Err(Q) = \frac{a_{-2}}{Q^2} + \frac{a_{-1}}{Q} + a_0 + a_1 \cdot Q + a_2 \cdot Q^2$$

After this correction has been made, the meter setting must be verified with at least one more test flow rate (recommended:  $0.25 \times \dots 1.0 \times Q_{\max}$ ). Enter the measurement deviations from the reference meter "as determined" into the RMGView<sup>RSM</sup> software. These values must agree with the predicted measurement deviation within  $\pm 0.1\%$ .

After the calibration, adjustment and verification of the RSM 200 has been completed, a calibration report with all relevant information can be automatically generated with the RMGView<sup>RSM</sup> software by clicking on the "Generate Report" button under Reports. Additional information about the tests can be entered as description data.

## D Structure of the archives

In this annex you will find more information about the archives:

- Archive size
- Archive types
  - Parameter archives
  - Event archives
  - Measurement values archive
- Archive header
- Reading out the archive data via Modbus

160

### D1 Archive size

The total available memory for archives is 506880 bytes. These are divided as follows:

Archive type	Bytes / Entry	Sum in bytes	Number of entries
Parameter archive (custody transfer)	34	10200	300
Parameter archive (not custody transfer)	34	10200	300
Event archive	18	3600	200
Period archive	42	369600	8800
Day archive	42	4200	100
Month archive	42	1050	25
<b>total</b>		<b>505950</b>	

### D2 Archive types

#### D2.1 Parameter archives

The parameter archive contains the history with all changes of the parameters. The time of the change and the old and new parameter values are saved in the archive.



The parameter archives are divided into one archive each for custody transfer and non-custody transfer parameters.

### Internal structure of an entry

Table of contents	Data type	Length in byte
Serial number	UINT16	2
Time and date (instrument time)	UINT32	4
Coordinate	UINT16	2
Old parameter value	CHAR	12
New parameter value	CHAR	12
CRC16 (Modbus)	UINT16	2
		<b>Total length: 34</b>

161

Coordinate:

- High Byte: Column ("A"- "Z" as ASCII)
- Low Byte: Line

A value in the Coordinate field of 4103h corresponds to coordinate A 03.

Old parameter value:

New parameter value:

The 12 bytes of the Parameter value field are filled and transferred depending on the type of the changed entry (coordinate).

Example: B05 QmMin IS\_FLOAT %.2f

The 1.4 bytes of the fields **Old parameter value** and **New parameter value** are interpreted as a Float and output in the format %.2f.

## D2.2 Event archives

In the event archive, error messages, warnings and notes are stored that occurred or disappeared (again) during operation of the RSM 200.

### Internal structure of an entry

Table of contents	Data type	Length in byte
Serial number	UINT16	2
Time and date (instrument time)	UINT32	4
Event type	UINT16	2
Event number	UINT16	2
Event information	CHAR	6
CRC16 (Modbus)	UINT16	2
		<b>Total length: 18</b>

Event type:

- High Byte: Type ('E' = Error, 'W' = Warning, 'N' = Note)
- Low Byte: 0 = Event goes, 1 = Event comes

Event info:

Binary information depending on the event type.

### D2.3 Measured value archives

Meter readings and average values of important measured variables are periodically stored in the measured value archives.

Three types of measured value archives are realized:

- Period archive (adjustable: 15, 30 or 60 minutes)
- Day archive
- Month archive

### Internal structure of an entry

Table of contents	Data type	Length in byte
Serial number	UINT16	2
Unix time (Instrument time)	UINT32	4
Standard volume	INT32	4
Measurement volume	INT32	4
Standard volume error	INT32	4
Measurement volume error	INT32	4
Exponent counter resolution	INT16	2
Counter digits	UINT16	2

Average pressure	FLOAT	4
Average temperature	FLOAT	4
Average compressibility	FLOAT	4
Status	UINT16	2
CRC16 (Modbus)	UINT16	2
		<b>Total length: 42</b>

The counter reading (volume) and the exponent of the counter resolution are used to create the counter reading display in cubic meters or cubic feet. On the display and in RMGView<sup>RSM</sup>, the volumes (standard volume, measurement volume, standard volume error and measurement volume error) are shown in the appropriate format. Archive values are not displayed: Exponent of counter resolution and counter locations.

### D3 Archive display

The archive is read from the EEPROM and shown on the display. The display consists of the status line and 5 other lines with a maximum length of 19 characters. The additional space on the right side is used to display the scrollbar. In the overview display, the first character of the display is reserved for the line marker.

Scrolling between entries is possible for parameter and event archive in the overview and detail view. In the measured value archive (monthly, daily, periodic archive) this is only possible in the overview display.

In the measured value archives, due to the high number of contents to be displayed, these are distributed over 4 pages of the detailed view. Switching between pages is done via the vertical scroll function. Each value x is displayed in a separate line, so the full number of digits of the number can be used.

### D4 Archive header

Each archive type contains an administrative header that contains information to retrieve the archive.

The header is structured as follows:

Table of contents	Data type	Length in byte
Order number of the next archive (largest value = 32768, then again = 0 )	UINT16	2

Index oldest entry	UINT16	2
Index most recent entry	UINT16	2
CRC16 (Modbus)	UINT16	2
		<b>Total length: 8</b>

164

There are four headers for each archive type, which are created in the memory as a ring buffer. In the event of cell defects in the EEprom, this should ensure that the information is stored safely. Each time a new archive entry is written, the associated archive header is updated and stored as the next entry in the ring buffer:

#### Initially empty header ring buffer after writing a new entry:

Memory index	
0	Archive header (Serial number 1) -> <b>Actual Header</b>
1	Empty
2	Empty
3	Empty

**Ring buffer after writing four entries:**

Memory index	
0	Archive header (Serial number 1)
1	Archive header (Serial number 2)
2	Archive header (Serial number 3)
3	Archive header (Serial number 4) -> <b>Actual Header</b>

165

**Ring buffer after writing six entries:**

Index	
0	Archive header (Serial number 5)
1	Archive header (Serial number 6) -> <b>Actual Header</b>
2	Archive header (Serial number 3)
3	Archive header (Serial number 4)

**Content of an empty header**

Table of contents	Data type	Value
Serial number next archive	UINT16	0
Index oldest entry	UINT16	FFFFh
Index most recent entry	UINT16	FFFFh
CRC16	UINT16	xxxxh

**Contents of the header, after writing the first archive entry:**

Table of contents	Data type	Value
Serial number next archive	UINT16	1
Index oldest entry	UINT16	0
Index most recent entry	UINT16	0
CRC16	UINT16	xxxxh

**Contents of the header, after writing the second archive entry:**

Table of contents	Data type	Value
Serial number next archive	UINT16	2
Index oldest entry	UINT16	0
Index most recent entry	UINT16	1

CRC16	UINT16	xxxxh
-------	--------	-------

### Content header, after writing 200 event archive entries (archive full):

Table of contents	Data type	Value
Serial number next archive	UINT16	200
Index oldest entry	UINT16	0
Index most recent entry	UINT16	199
CRC16	UINT16	xxxxh

### Contents of the header, after writing 201 event archive entries. (archive full, oldest entry in ring buffer overwritten):

Table of contents	Data type	Value
Serial number (next archive)	UINT16	201
Index oldest entry	UINT16	1
Index most recent entry	UINT16	0
CRC16	UINT16	xxxxh

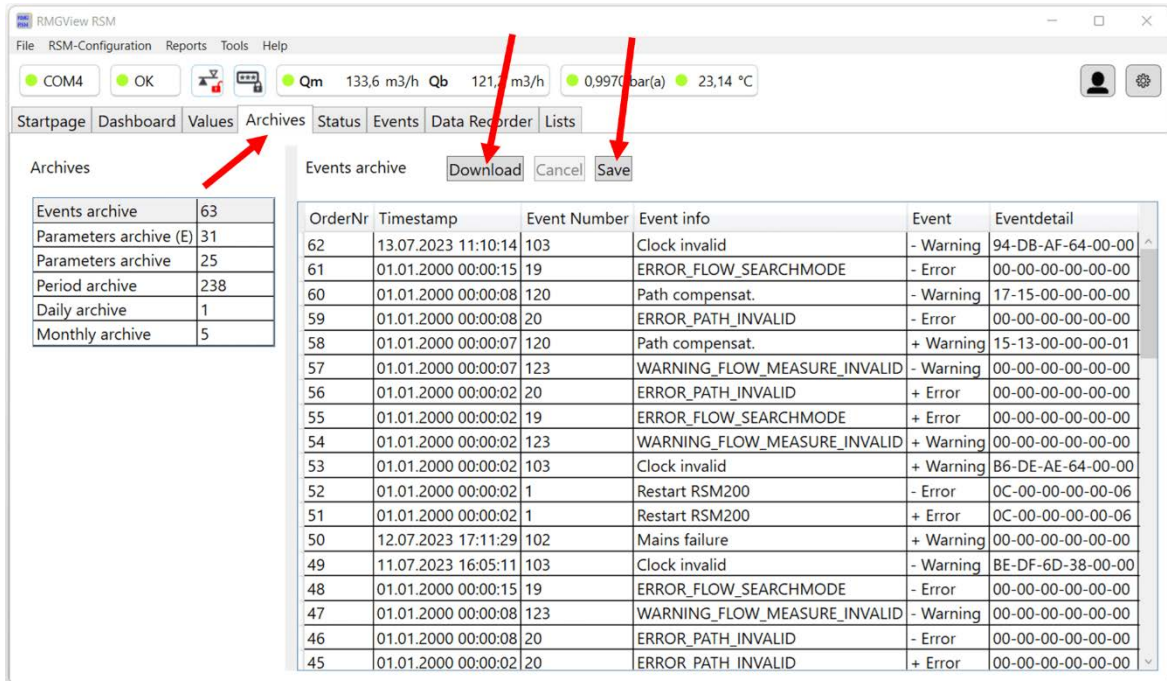
Procedure for determining the indexes to be read in the archive:

- Reading all four archive headers of an archive type
- Detecting the current header
- Determining the area to be read:
  - If "Index oldest entry" = FFFFh and "Index newest entry" = FFFFh, then the associated archive is empty.
  - If "Index oldest entry" = 0 and "Index newest entry" = 0, then the archive contains one entry.
- If "Index oldest entry" < "Index newest entry", then the number of entries = "Index newest entry" - "Index oldest entry" + 1
- If "Index oldest entry" > "Index newest entry", then the No. of entries = max archive entry - "Index oldest entry" + "Index newest entry" + 1 (Archive is always full: Number of entries = Maximum archive entries)

## D5 Reading of archive data via RMGView<sup>RSM</sup>

The data accumulated in the archives can be conveniently read out via the RMGView<sup>RSM</sup> software. To do this, go to the "Archives" tab, then "Download",

through this command the data will be retrieved to the PC, and then "Save". The next figure shows the procedure.



**Figure 52: Reading of the archives**

The displayed data is then saved in an Excel-readable \*.csv format and can be further processed from there.

## D6 Reading of the archive data via Modbus

Archive entries can be retrieved via Modbus. The command 14h "Read General Reference" is used for this purpose. This command can be used to index the storage areas of the archives and the associated management headers (see document: „Modicon Modbus Protocol; Reference Guide (PI-MBUS-300 Rev. J)“)

The RSM 200 only supports the processing of a subrequest within a request.

The structure of the request string is as follows:

Byte	Meaning
1	Device address
2	Function (14h)
3	Number of bytes (07h)
4	Reference type (00h)
5	File number (Hi)
6	File number (Lo)
7	Start index (Hi)
8	Start index (Lo)
9	Number of registers to be read (Hi)
10	Number of registers to be read (Lo)
11	CRC (Lo)
12	CRC (Hi)

The reference type to be specified in the request string is not checked in the RSM 200.

The following file number selects the archive to be read, or an archive header:

File number	Archive type
1	Administrative header calibration office parameter archive
2	Calibration office parameter archive
3	Administrative header parameter archive
4	Parameter archive
5	Administrative header event archive
6	Event archive
7	Administrative header period archive
8	Period archive
9	Administrative header day archive
10	Day archive
11	Administrative header month archive
12	Month archive

The file address is used to select the index of the archive to be read.

The number of registers of bytes read from an archive entry (number of bytes = number of registers x 2). The maximum number of registers to be read is limited to 125 per request.

The following example shows the data to be read out for a request with:



- File number           6 (Event archive, size: 12 bytes per entry)
- Start index           7 (Read from index 7)
- Number of registers: 13

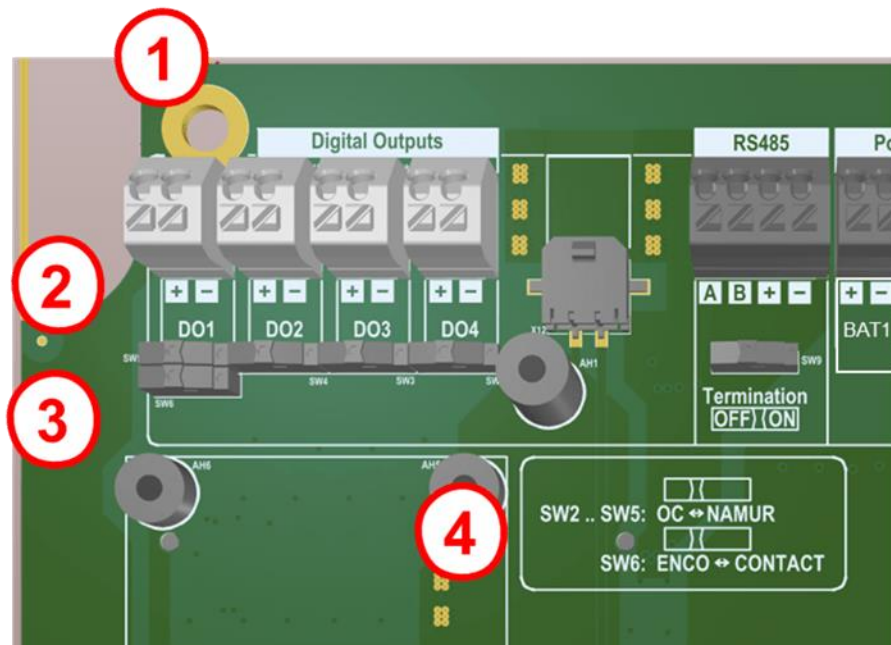
Archive index	Modbus register	Internal memory address of the RSM 200
7	1 (Hi)	0 (+ Offset)
	1 (Lo)	1 (+ Offset)
	2 (Hi)	2 (+ Offset)
	2 (Lo)	3 (+ Offset)
	...	...
	6 (Hi)	10 (+ Offset)
8	6 (Lo)	11 (+ Offset)
	7 (Hi)	12 (+ Offset)
	7 (Lo)	13 (+ Offset)
	8 (Hi)	14 (+ Offset)
	8 (Lo)	15 (+ Offset)
	...	...
9	12 (Hi)	22 (+ Offset)
	12 (Lo)	23 (+ Offset)
	13 (Hi)	24 (+ Offset)
	13 (Lo)	24 (+ Offset)

The example shows the readout of two complete event archive entries (index 7 and 8) and a partial archive (2 bytes from index 9). In practice, it makes sense to ask only complete archives. The above case serves only to illustrate the mechanism.

## E Encoder protocol

The encoder protocol transmits the counter reading of the measurement volume of **coordinates A08 Measurement volume**  $V_b$  to a corrector, e.g. the ERZ2000-NG or EVC Primus 400. The selected resolution (**resolution exponent A20**) is rendered; after switching the resolution, the transmission is also switched.

The encoder protocol is activated via the digital output DO1 if "Encoder" is selected in the **S01 Mode DO1** selection. In addition, it is necessary to set:



**Figure 53: Connection of the encoder**

- (1) - Connection DO1; Please observe the polarity (+/-)
- (2) - The upper slider for Namur is to be set to the left (see (4) above)
- (3) - The lower slider for Encoder is to be set to the left (see (4) above)
- (4) - Slider position for Namur, or encoder

The encoder protocol consists of 2 parts, the encoder protocol A and the encoder protocol B. The encoder protocol A transmits the counter reading  $Q_m$  to a corrector, e.g., the ERZ2000-NG, when the resolution is switched over, this value is transmitted. The encoder protocol B contains information about the sending device, the RSM 200 such as serial number, manufacturer, unit of the counter.

As described in DVGW Information Gas No. 23, the baud rate is 2400 Bd. Encoder protocol A and B are only queried if an (external) Namur voltage is applied to the terminals. After the Namur voltage is applied, an encoder telegram A is sent after 150 ms. After another 300 ms an encoder telegram B is sent. After that, in each case at the distance defined in **coordinate S16 Enco. Tel. distance**, telegrams

are sent. The sequence of the telegrams is set after the two start telegrams via **coordinate S17 Enco. B Tel. occur**. This value indicates which telegram is encoder telegram B (e.g.: 5 means that the 5th encoder telegram in each case is encoder telegram B.)

This results in 2 different operating modes/requirements of the encoder interface:

1. The Namur voltage is always present (e.g. ERZ2000-NG). In this operating mode, the RSM 200 controls the number and cycles of the encoder telegrams.
2. The Namur voltage is switched on by the encoder only as required (e.g. EVC Primus 400). The above specification then allows the corrector to switch off the voltage after receiving the encoder telegram A. If the converter does not switch off the voltage after encoder telegram A, then it also receives encoder telegram B. For power saving reasons, the timing in battery operation is based on the clock rate of the ultrasonic measurement. That is, the specified times may be subject to errors of 1/clock rate [s]. To ensure reliable transmission, the CRC Start check in **S20 EncoderCRCStart** should be set to "ENCODER\_CR\_START\_7F" (at least for the Primus 400).

## F Calculation of the Reynolds number

### Note

The calculation of the Reynolds number will be handled after an implementation via an additional tool in the RMGView<sup>RSM</sup>. This tool is then described in more detail. Currently, the calculation of the medium factor is only possible "manually"; the basic procedure is described here.

172

If - as is common in gas measurement technology - the dynamic viscosity is used to calculate the Reynolds number instead of the kinematic one, then we obtain:

$$Re = \frac{u \cdot d}{\nu} = \frac{u \cdot d \cdot \rho}{\eta}$$

The parameter  $d$  is determined by the nominal diameter and the velocity is determined by the ultrasonic measuring method. The pressure- and temperature-dependent quantities density  $\rho$  and dynamic viscosity  $\eta$  must be determined more precisely.

Simplified, the determination can be made using a medium factor  $Mf$ :

$$Mf = \frac{1}{R_{spez} \cdot Z \cdot \eta}$$

These are:

$R_{spez}$  – specific gas constant

$$R_{spez} = \frac{R}{m}$$

with

$R$  – general or universal gas constant;  
 $R = 8.31446 \text{ J}/(\text{mol} \cdot \text{K})$

$m$  – Specific molar mass  
 Calculated using an Excel tool based on the AGA8  
 (see below for more information).

$Z$  – Real gas factor

Calculated using an Excel tool based on the AGA8 (see below for more information).

$\eta$  – dynamic viscosity

If the dynamic viscosity at standard conditions  $\eta_0$  (0°C or 273.15°K; and 1.013 bar) is known, then the dynamic viscosity  $\eta$  can be calculated using the Sutherland formula:

$$\eta = \eta_0 \cdot \frac{T_0 + C}{T + C} \cdot \left(\frac{T}{T_0}\right)^{\frac{3}{2}}$$

with

$T$  -temperature [°K]

$T_0$  – Standard temperature [°K];  $T_0 = 273.15$  °K

$C$  – Sutherland constant;

for air this value is 120°K,

natural gas is set here constant 130°K

If the dynamic viscosity at standard conditions is known, this formula can be used to calculate the temperature-dependent viscosity via an Excel program (see below for further information).

---

 173
 

---

From this, the Reynolds number is given by:

$$Re = \frac{u \cdot d \cdot p}{(T + 273,15)} \cdot 100.000 \cdot Mf$$

Where

$p$  – Pressure; [p] = bar (a)

$u$  – [u] = m/s

$d$  – [d] = m

$T$  – [T] = °C

Automatic mode is valid only for air and natural gas. The calculation of the medium factor  $Mf(T)$  is done via:

$$Mf(T) = a_2 \cdot T^2 + a_1 \cdot T + a_0$$

$T$  - temperature in °C

$Mf$ - is the medium factor, it is dimensionless

In the RSM 200 firmware, the parameters are handled in the specified units; thus, the Reynolds number becomes dimensionless.

If the temperature  $T$  is not measured or is set as a fixed value, then  $T$  can be determined via the speed of sound measured by ultrasound:

$$T[°C] = b_2 \cdot \left(c_{Gas} \left[\frac{m}{s}\right]\right)^2 + b_1 \cdot c_{Gas} \left[\frac{m}{s}\right] + b_0$$

When determining the Reynolds number, the pressure is required as a parameter. If this value is not measured or set as a fixed value, it is set to 10 bar by default.

For any gas, an Excel tool takes care of calculating the coefficients for  $Mf$   $a_2$ ,  $a_1$  and  $a_0$  and the temperature  $T$   $b_2$ ,  $b_1$  and  $b_0$ .

## The Excel tool: Calculation medium factor according to AGA 8

So far this excel-tool only exists as German version. In the Excel tool, the gas percentages are to be entered in column B in the cells highlighted in yellow. Not all 21 components have to be listed, empty cells are interpreted as 0%. The methane value is calculated automatically, it is the "rest" to 100%.

In cell E15, enter the viscosity of the natural gas at 0°C. Also this field is yellow.

All (!!) user inputs are displayed in yellow.

All other fields must not be written!

The next figure shows the input and output of the Excel tool; this excel tool only exists as German version.

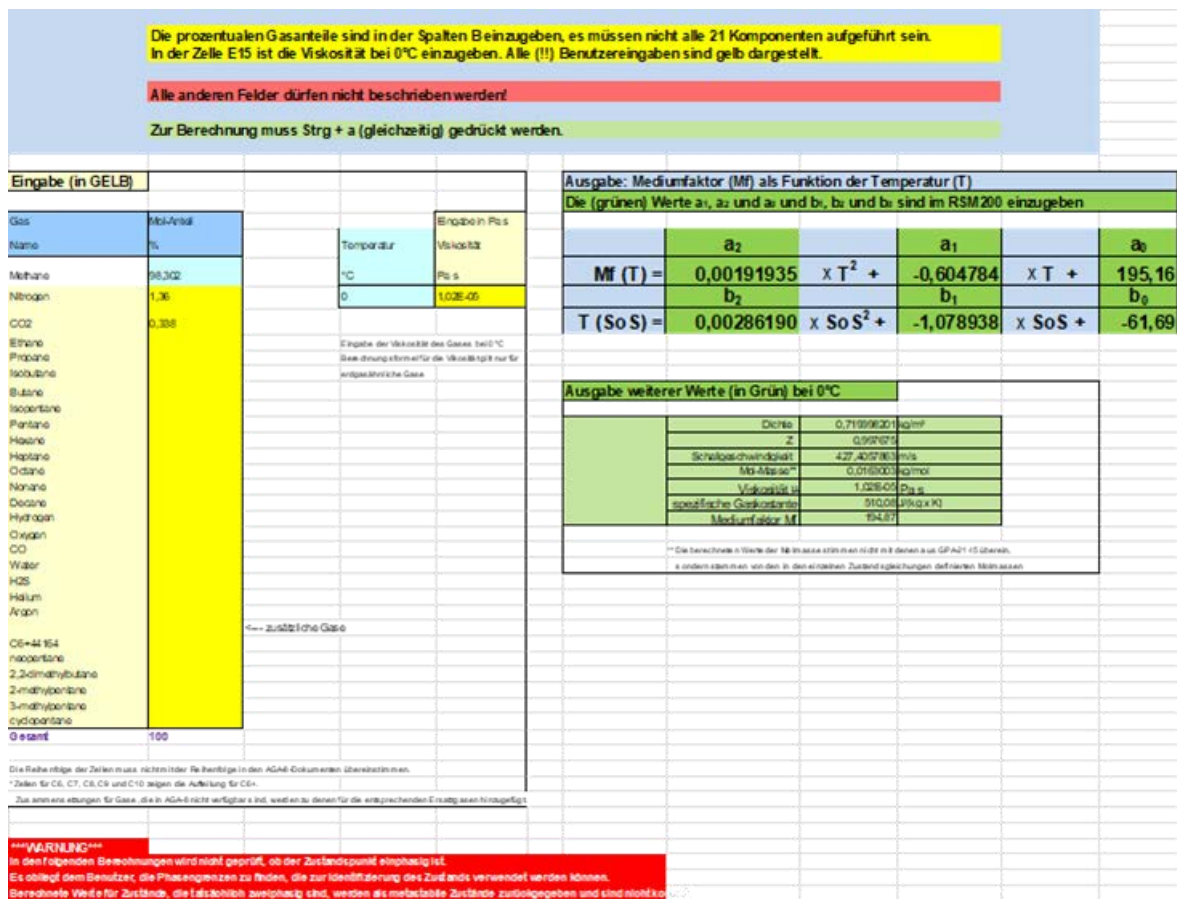


Figure 54: Input and output of the Excel tool

After entering the viscosity and the gas fractions, the program calculates the new coefficients with the command "Ctrl + a" (both must be pressed simultaneously). This command is to be executed on the Excel "Surface" page.

The new coefficients to be entered into the RSM 200 can be found in the green highlighted fields under the designations  $a_2$ ,  $a_1$  and  $a_0$ , and  $b_2$ ,  $b_1$  and  $b_0$ .

## G Dimensions

### RSM200 DN50 / NPS 2"

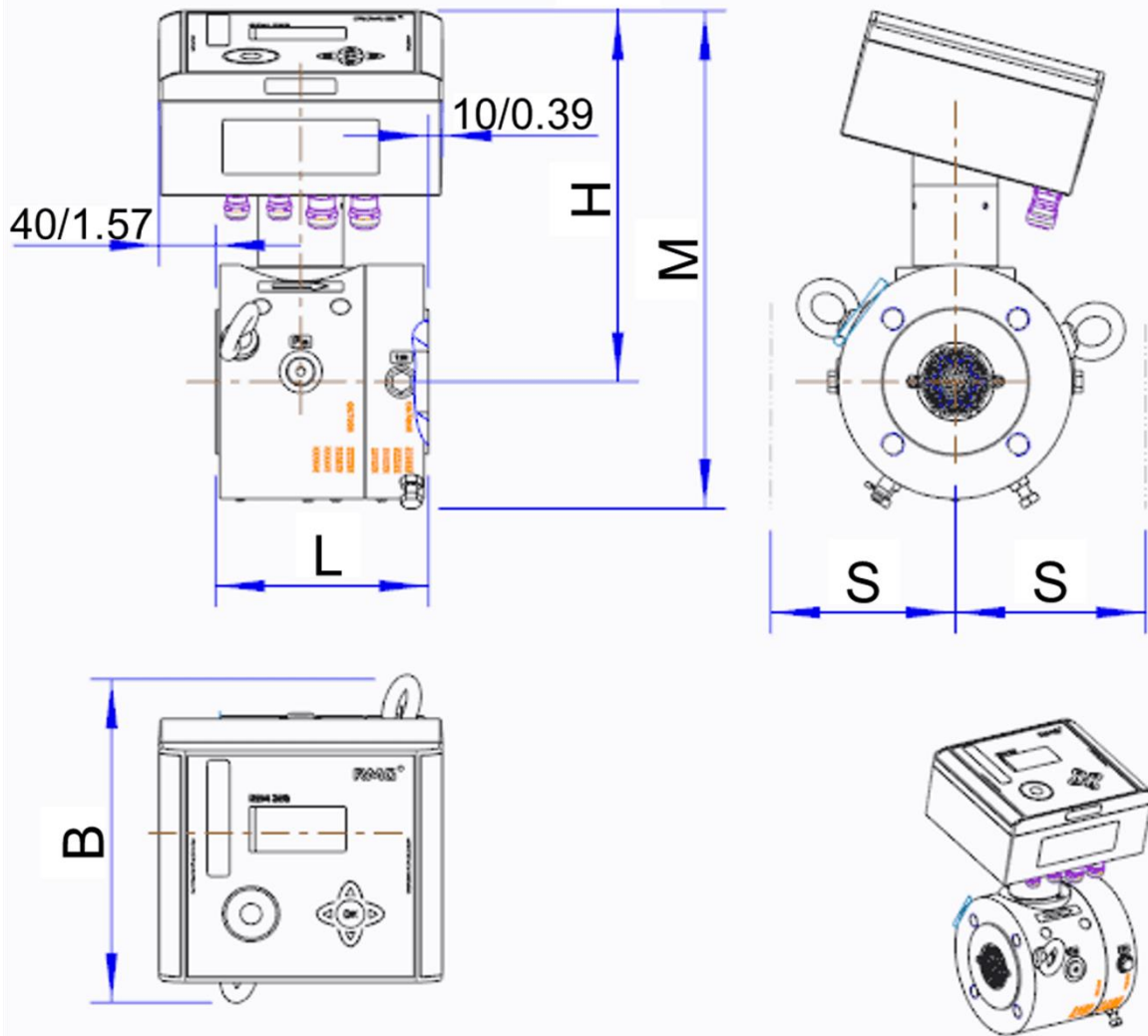
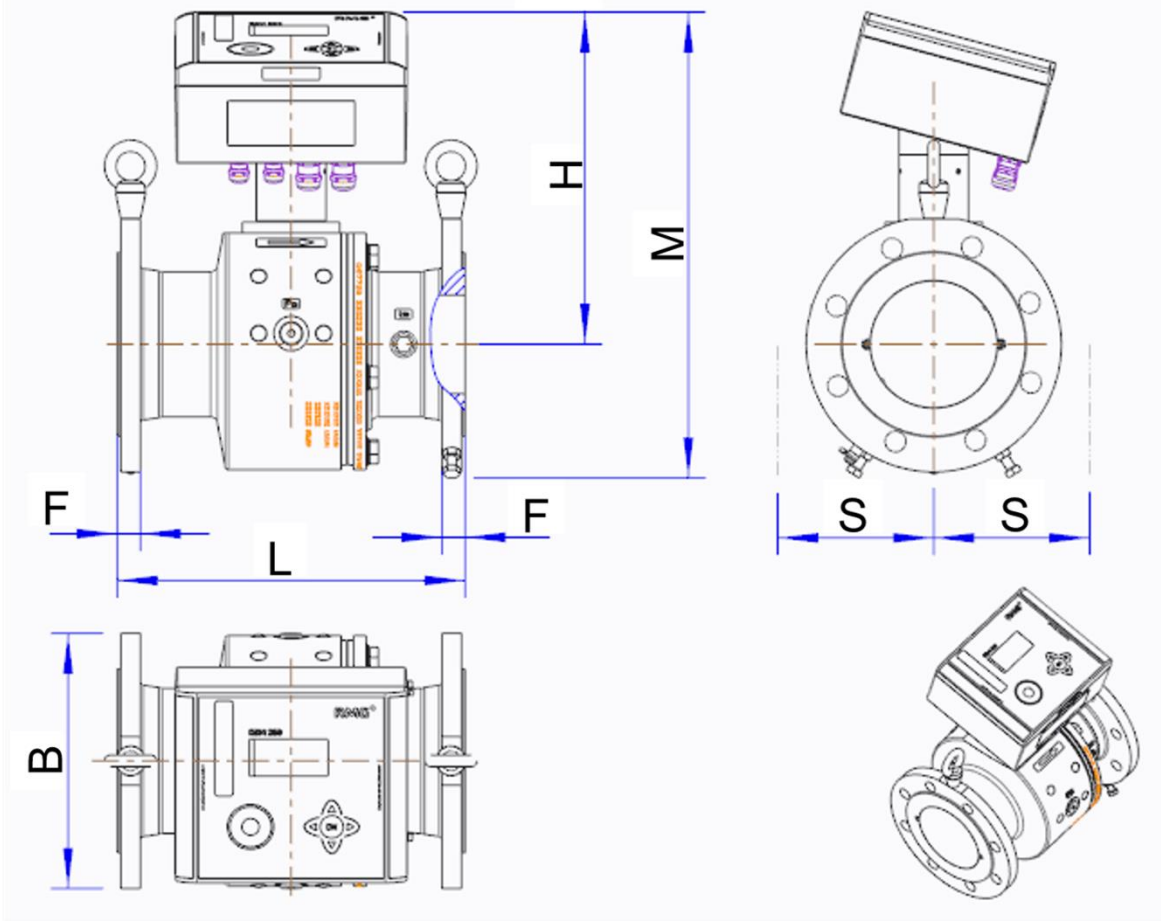


Figure 55: DN50



**RSM200 DN80 – DN200 / NPS 3" – NPS 8"**



177

---



---



---



---

**Figure 56: DN80 – DN200**

DN / Size		Pressure range	Dimensions / Dimensions [mm] / [inch]					Weight / Weight [kg] / [lbs]	
			L	H	M	F	B	S	
50	2"	PN10	150 / 5.9	261 / 10:28 AM	351 / 13.82	-	228 / 8.99	200 / 7.87	27/60 <b>16/35</b>
		PN16							
		ANSI150							
80	3"	PN10	240 / 9:45 AM	279 / 10.98	383 / 3:08 PM	20 / 0.79	205 / 8:07 AM	220 / 8.66	35/77 <b>18/40</b>
		PN16			378 / 14.88	24.8 / 0.98			
		ANSI150							
100	4"	PN10	300 / 11.8	286 / 11:26 AM	402 / 15.83	20 / 0.79	230 / 9:06 AM	240 / 9:45 AM	46/101 <b>22/49</b>
		PN16			407 / 4:02 PM	26.9 / 1:06 AM			
		ANSI150							50/110 <b>24/53</b>
150	6"	PN10	450 / 17.7	321 / 12.64	464 / 6:27 PM	22 / 0.87	285 / 11:22 AM	260 / 10:24 AM	91/201 <b>40/88</b>
		PN16			461 / 6:15 PM	29.5 / 1:16 AM			
		ANSI150							94/207 <b>41/90</b>
200	8"	PN10	600 / 23.6	347 / 16.66	512 / 8:15 PM	25 / 0.98	343 / 1:50 PM	290 / 11:42 AM	153/337 <b>63/139</b>
		PN16			514 / 8:24 PM	31.6 / 1:24 AM			
		ANSI150							157/346 <b>65/143</b>

Weights are approximate, they may vary due to casting tolerances.

Size S (lateral distance) should be maintained to ensure clearance for add-on parts.

The weights for meters with a cast or fine-grained steel housing are in "normal" type, those for meters with an aluminum housing are in "bold" type.

**Electronics case:**

200 mm x 180 mm x 100 mm

## H Type plate

Type plate of RSM 200 VM (VMF) for the European area, the area of validity of ATEX / MID / PED (generally the area where metric units apply).






<b>RSM 200-VM</b>		RMG Messtechnik GmbH Otto-Hahn-Str. 5 35510 Butzbach / Germany		<b>RMG</b>	
DN		Q <sub>min</sub>	Q <sub>t</sub>	Q <sub>max</sub>	
SN					m <sup>3</sup> /h
Year		PT			bar
Gas meter Certificate No. tba MPE 1.0%		PS			bar
		TS	-40/+80		°C
		T <sub>gas</sub>			°C
		T <sub>amb</sub>			°C
		M2, E2, IP66			
		P <sub>op,min</sub> , P <sub>op,max</sub> and C <sub>p</sub> see display / voir écran / ver pantalla			
		ID: X XXXXX XXXX XXXX			
		conformity with: ASME B 31.3, ASME B 31.8			
0158, 0102, 0091					
				II 2 G Ex ia IIC T4 Gb BVS 23 ATEX E 019 X IECEX BVS 23.0011X	
		Ext. Power Supply on X5:			
Mode	U <sub>i</sub>	I <sub>i</sub>	P <sub>i</sub>	C <sub>i</sub>	L <sub>i</sub>
P1	supplied internally				
P2	11,2 V	122 mA	550 mW	0 nF	0,253 mH
P3	11,2 V	122 mA	1100 mW	0 nF	0,253 mH
		 <b>WARNING:</b> Do not replace battery when an explosive atmosphere is present. Electrical data see Certificate and Operating Instructions.			
		Model name: RSM 200-VM-XXX-XX-XXX			

Figure 57: Type plate for the European validity area

Type plate of RSM 200 VM (VMF) for the North American area, the area of validity of ASME / CSA / FM (generally the area in which imperial units apply).






<b>RSM 200-VM</b>		RMG Messtechnik GmbH Otto-Hahn-Str. 5 35510 Butzbach / Germany		<b>RMG</b>	
DN		Q <sub>min</sub>	Q <sub>t</sub>	Q <sub>max</sub>	
SN					ft <sup>3</sup> /h
Year		PT			psig
Gas meter Certificate No. tba MPE 1.0%		PS			psig
		TS	-40/+175		°F
		T <sub>gas</sub>			°F
		T <sub>amb</sub>			°F
		M2, E2, IP66			
		P <sub>op,min</sub> , P <sub>op,max</sub> and C <sub>p</sub> see display / voir écran / ver pantalla			
		ID: X XXXXX XXXX XXXX			
		conformity with: ASME B 31.3, ASME B 31.8			
0158, 0102, 0091					
				II 2 G Ex ia IIC T4 Gb BVS 23 ATEX E 019 X IECEX BVS 23.0011X	
		Ext. Power Supply on X5:			
Mode	U <sub>i</sub>	I <sub>i</sub>	P <sub>i</sub>	C <sub>i</sub>	L <sub>i</sub>
P1	supplied internally				
P2	11,2 V	122 mA	550 mW	0 nF	0,253 mH
P3	11,2 V	122 mA	1100 mW	0 nF	0,253 mH
		 <b>WARNING:</b> Do not replace battery when an explosive atmosphere is present. Electrical data see Certificate and Operating Instructions.			
		Model name: RSM 200-VM-XXX-XX-XXX			

Figure 58: Type plate for the North American validity area

Type plate of RSM 200 VC (VCF) for the European area, the area of validity of ATEX / MID / PED (generally the area where metric units apply).

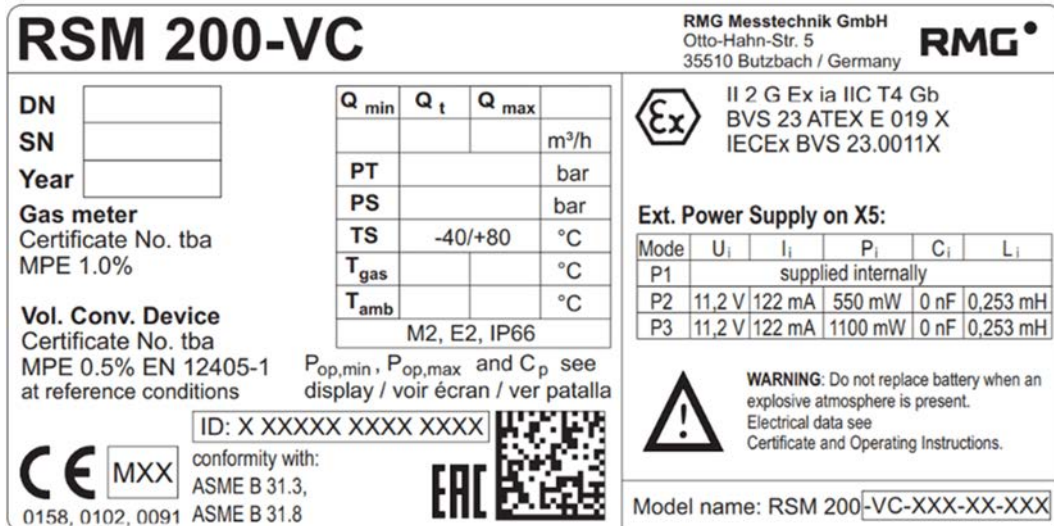


Figure 59: Type plate for the European validity area

Type plate of RSM 200 VC (VCF) for the North American area, the area of validity of ASME / CSA / FM (area in which imperial units apply).

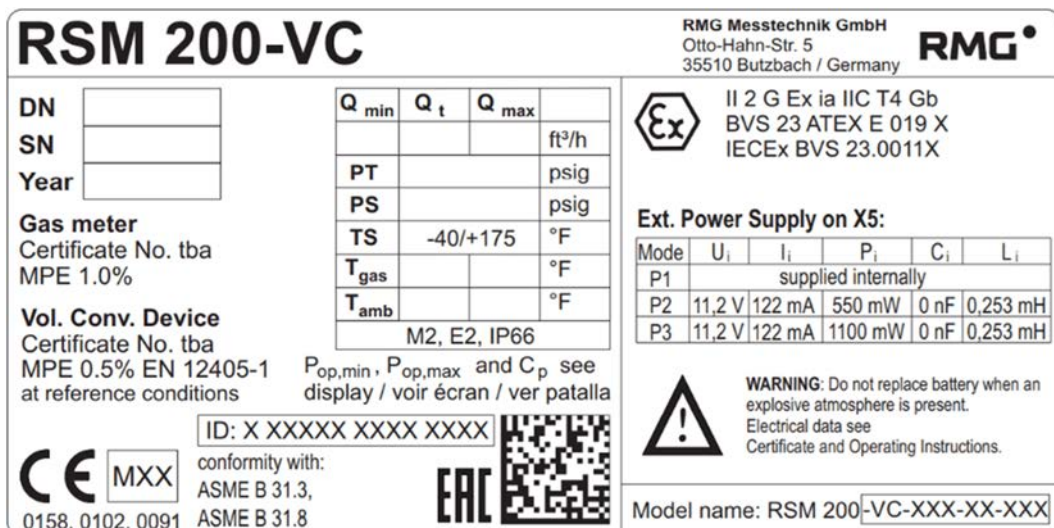
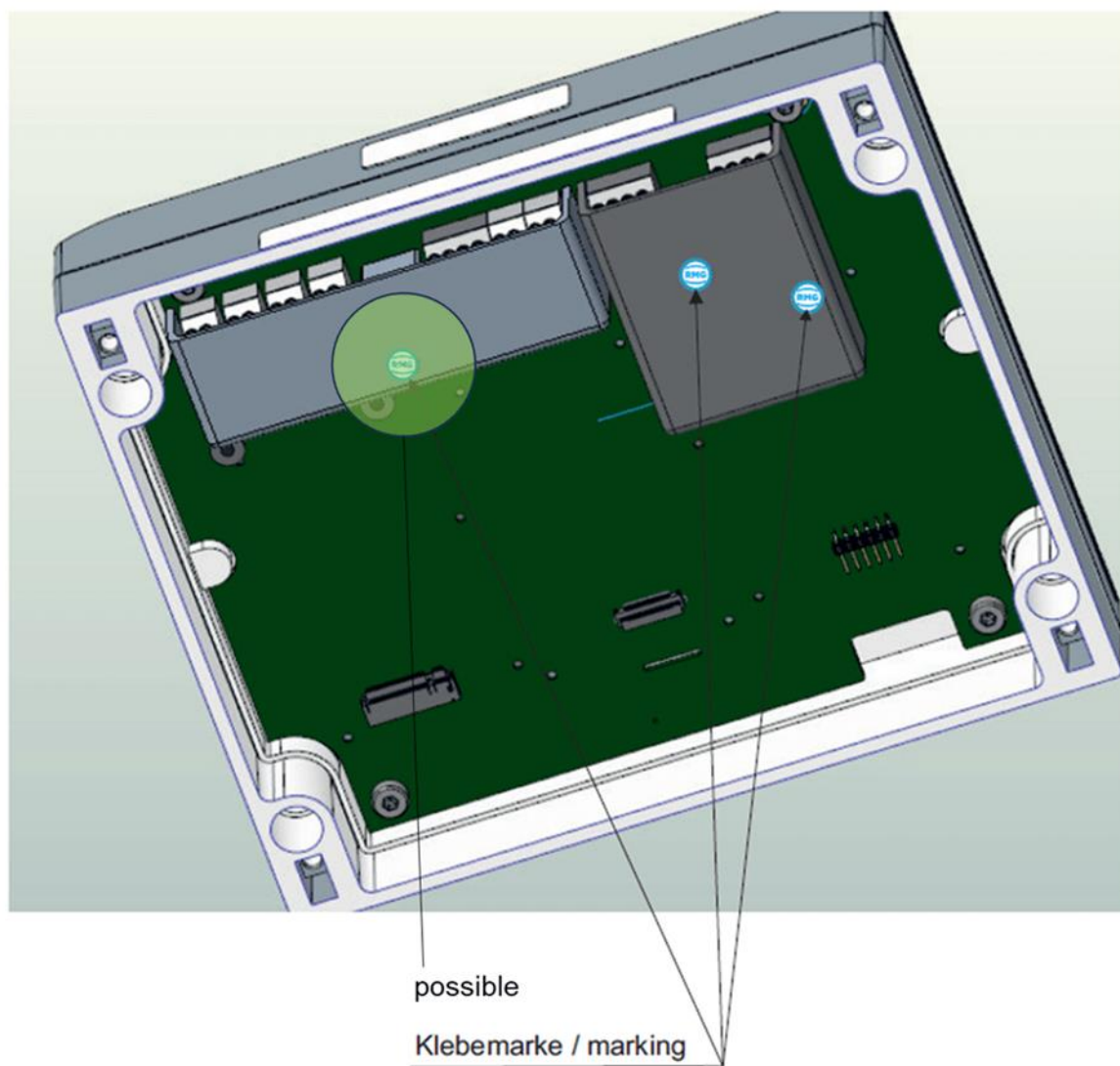


Figure 60: Type plate for the North American validity area

# I Seal plans

The following figures show the positions of the seals on the RSM 200.



181

---



---

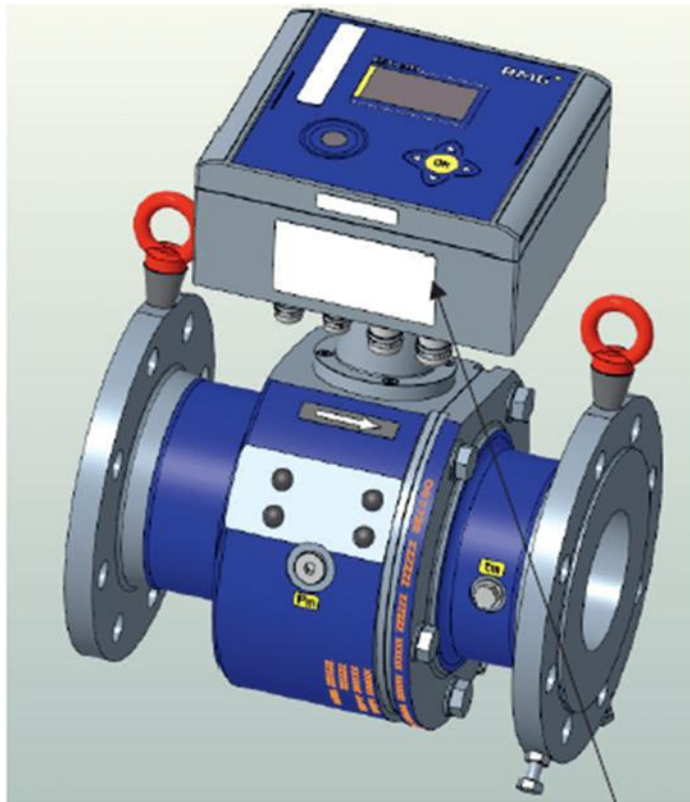


---



---

**Figure 61: Seals in the inner of RSM 200**



Klebmarke / marking

Neben / beside

Typenschild / Type plate

**Figure 62: Seals at the electronic housing of RSM 200**

## J Spare parts

Below is the ordering list of RSM 200 spare parts and explanatory drawings defining the drawing numbers. To facilitate a possible order, the corresponding RMG order codes are also included.

183

### Warning

**In principle, no components in the gas meter may be replaced without further metrological inspection. Batteries may be replaced in the electronic housing; other electronic components may be replaced under custody transfer supervision without further metrological testing.**

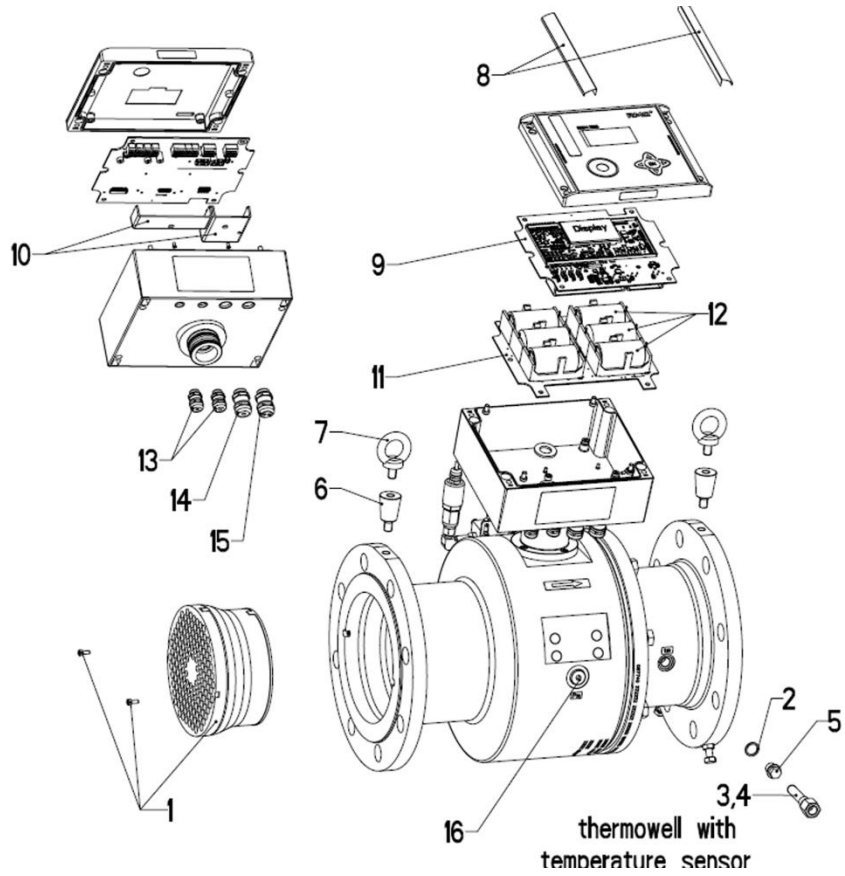
**Always coordinate possible repairs or replacement of parts of the RSM 200 with RMG's service department (contact details: see second or last page). Have any necessary repairs or replacement of parts of the RSM 200 carried out by RMG Service or an authorized service center.**

**Replacing parts or repairing the RSM 200 generally breaks the seal of the device and the RSM 200 must be resealed. In addition, the calibration must usually be renewed.**

**Coordinate with the RMG service department that the correct spare parts are ordered; an exchange or a return of these orders is generally not possible.**

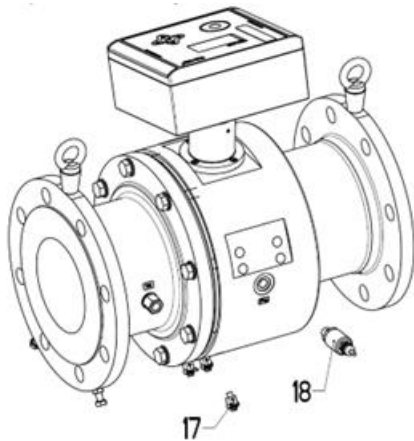
**General version**

184

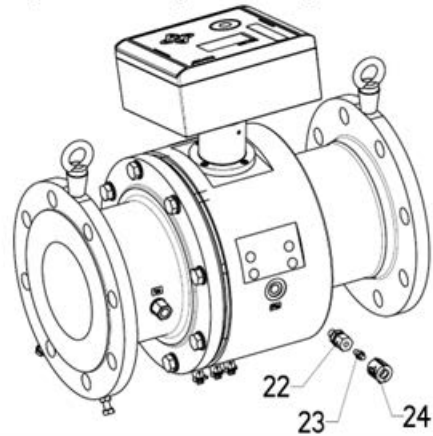


**Figure 63: RSM 200 (General version)**

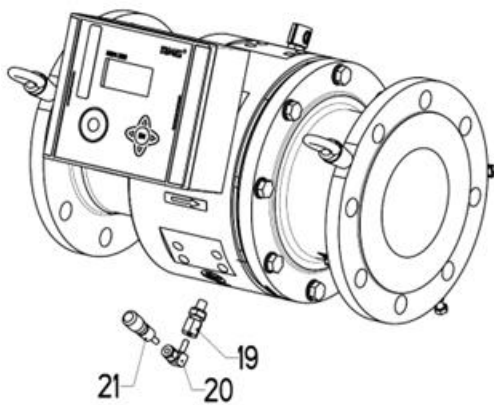




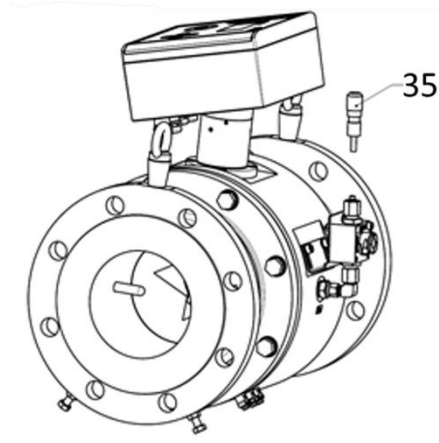
**Figure 64: General version with pressure transducer**



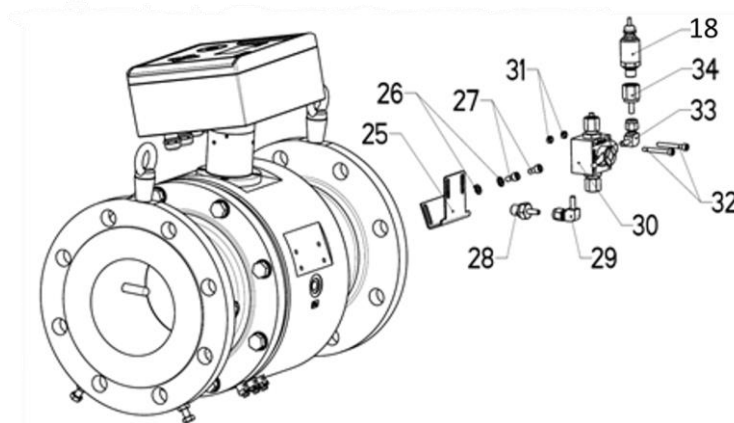
**Figure 65: Version with Pressure port  $\varnothing$  6 mm**



**Figure 66: Version pressure connection  $\varnothing$  6 mm and mini measuring coupling**



**Figure 67: Version with 3-way stopcock and mini measuring coupling**



**Figure 68: Version with 3-way valve with pressure transducer**

Z.Pos. / drw.pos.	Artikelbezeichnung / Article description	DN50	DN80	DN100	DN150	DN200
1	Gleichrichter mit Schrauben/flow conditioner with screws	38.68.246.00	38.68.247.00	38.68.248.00	38.68.249.00	38.68.250.00
2	Dichtring G1/4 / Sealing ring G1/4	81.54.614.00	81.54.614.00	81.54.614.00	81.54.614.00	81.54.614.00
3	Schutzrohr / Thermowell	00.58.647.00	00.55.518.14	00.55.518.14	00.54.365.14	00.54.365.14
4	Temperaturaufnehmer / Temperature transmitter	38.01.100.12	38.01.100.12	38.01.100.12	38.01.100.12	38.01.100.12
5	Verschlusschraube DIN910 / Locking screw DIN910	60.97.211.00	60.97.211.00	60.97.211.00	60.97.211.00	60.97.211.00
6	Ringschraubenadapter / Eyebolt adapter	-	00.67.702.00	00.67.702.00	00.67.759.00	00.67.759.00
7	Ringschraube / Eyebolt	30.00.612.00	30.00.612.00	30.00.612.00	30.00.613.00	30.00.613.00
8	Set Abdeckleisten E-Gehäuse / Set cover strips	30.00.799.00	30.00.799.00	30.00.799.00	30.00.799.00	30.00.799.00
9	Platine RSM200 mit Verguss	00.68.257.00	00.68.257.00	00.68.257.00	00.68.257.00	00.68.257.00
10	Platine mit Abdeckungen RSM200 Elektronik	38.68.257.00	38.68.257.00	38.68.257.00	38.68.257.00	38.68.257.00
11	Batterie Board / Battery board	98800-17421	98800-17421	98800-17421	98800-17421	98800-17421
12	Lithium Batterie Set aus 3 Batterien / Lithium battery set with 3 batteries	30.00.944.00 3x oder/or 30.00.945.00 3x oder/or 92102-00160 3x	30.00.944.00 3x oder/or 30.00.945.00 3x oder/or 92102-00160 3x	30.00.944.00 3x oder/or 30.00.945.00 3x oder/or 92102-00160 3x	30.00.944.00 3x oder/or 30.00.945.00 3x oder/or 92102-00160 3x	30.00.944.00 3x oder/or 30.00.945.00 3x oder/or 92102-00160 3x
13	Kabelverschraubung M12x1,5 / Cable-gland M12x1,5	87.06.090.00	87.06.090.00	87.06.090.00	87.06.090.00	87.06.090.00
14	Kabelverschraubung M16x1,5 / Cable-gland M16x1,5	87.06.091.00	87.06.091.00	87.06.091.00	87.06.091.00	87.06.091.00
15	Kabelverschraubung M16x1,5 (2x4) / Cable-gland M16x1,5 (2x4)	30.00.762.00	30.00.762.00	30.00.762.00	30.00.762.00	30.00.762.00
16	Verschluss-Stopfen G1/4 A / Locking screw G1/4 A	30.00.638.00	30.00.638.00	30.00.638.00	30.00.638.00	30.00.638.00
17	Erdungsklemme / Grounding terminal	30.00.668.00	30.00.668.00	30.00.668.00	30.00.668.00	30.00.668.00
18	Digitaler Druckaufnehmer / Digital Pressure Transmitter					
	0,8-20 bara	30.00.756.00	30.00.756.00	30.00.756.00	30.00.756.00	30.00.756.00
	4-20 bara	30.00.861.00	30.00.861.00	30.00.861.00	30.00.861.00	30.00.861.00
	0,8-10 bara	30.00.860.00	30.00.860.00	30.00.860.00	30.00.860.00	30.00.860.00
	0-25 barg	30.00.870.00	30.00.870.00	30.00.870.00	30.00.870.00	30.00.870.00
	0,8-5,2 bara	30.00.859.00	30.00.859.00	30.00.859.00	30.00.859.00	30.00.859.00

Multiplikatoren geben an, wenn die jeweilige Referenznummer mehr als 1x mal bestellt werden muss (2x, 3x, ...).  
Multipliers give if the specific reference number has to be ordered more than 1x time (2x, 3x, ...).

Z.Pos. / drw.pos.	Artikelbezeichnung / Article description	DN50	DN80	DN100	DN150	DN200
19	Einschraubverschraubung G1/4 auf ø6 / Screw connection G1/4 to ø6	30.00.765.00	30.00.765.00	30.00.765.00	30.00.765.00	30.00.765.00
20	Winkelreduzierverschraubung / Elbow-reducer connector	30.00.760.00	30.00.760.00	30.00.760.00	30.00.760.00	30.00.760.00
21	Minimesskupplung / Mini-measurement coupling	90.45.156.00	90.45.156.00	90.45.156.00	90.45.156.00	90.45.156.00
22	Einschraubverschraubung G1/4 auf ø6 / Screw connection G1/4 to ø6	30.00.765.00	30.00.765.00	30.00.765.00	30.00.765.00	30.00.765.00
23	Verschlussbutzen / Plug	30.00.648.00	30.00.648.00	30.00.648.00	30.00.648.00	30.00.648.00
24	Plombe für Verschraubung / Seal for screw connector	00.60.316.00	00.60.316.00	00.60.316.00	00.60.316.00	00.60.316.00
25	Halteblech 3-W-Kugelhahn / Support bracket 3-W-Ball valve	00.67.701.00	00.67.701.00	00.67.701.00	00.67.757.00	00.67.757.00
26	Scheibe / Washer	62.80.614.00	62.80.614.00	62.80.614.00	62.80.614.00	62.80.614.00
27	Innensechskantschraube M6 / Hexagon socket screw M6	60.64.919.00	60.64.919.00	60.64.919.00	60.64.919.00	60.64.919.00
28	Rohrstützen / Pipe socket	30.00.763.00	30.00.763.00	30.00.763.00	30.00.763.00	30.00.763.00
29	Winkelreduzierverschraubung / Elbow-reducer connector	30.00.760.00	30.00.760.00	30.00.760.00	30.00.760.00	30.00.760.00
30	3-Wegekugelhahn / 3-way-valve	30.00.646.00	30.00.646.00	30.00.646.00	30.00.646.00	30.00.646.00
31	Sechskantmutter / Hexagon nut	62.62.519.00	62.62.519.00	62.62.519.00	62.62.519.00	62.62.519.00
32	Innensechskantschraube M5 / Hexagon socket screw M5	60.64.910.00	60.64.910.00	60.64.910.00	60.64.910.00	60.64.910.00
33	Winkelreduzierverschraubung / Elbow-reducer connector	30.00.760.00	30.00.760.00	30.00.760.00	30.00.760.00	30.00.760.00
34	Aufschraubadapter / Screw-on adapter	30.00.764.00	30.00.764.00	30.00.764.00	30.00.764.00	30.00.764.00
35	Minimesskupplung / Mini-measurement coupling	90.45.156.00	90.45.156.00	90.45.156.00	90.45.156.00	90.45.156.00

Multiplikatoren geben an, wenn die jeweilige Referenznummer mehr als 1x bestellt werden muss (2x, 3x, ...).  
Multipliers give if the specific reference number has to be ordered more than 1x time (2x, 3x, ...).

## K Firmware download

### Warning

In general, the RSM 200 is delivered fully functional. A download of a "new" or adapted firmware is only recommended on the advice of RMG's service department; have a download carried out by RMG's service department or an authorized agency.

Since pressing the calibration button is required to complete the download, custody transfer instruments must be calibrated by a custody transfer supervisor. Afterwards, the device must be sealed again.

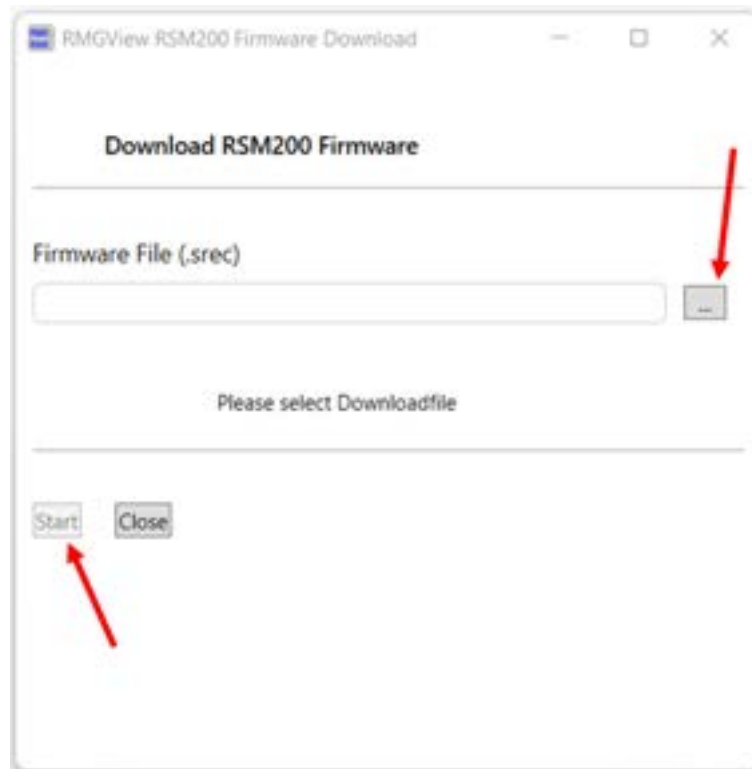
An "incorrectly" executed download can block functions of the RSM 200 or execute new, other improperly; a device that is no longer operational can then be the result or it can possibly measure incorrectly.

If necessary, a firmware download must be performed. The implementation via RMGView<sup>RSM</sup> is easy. Call up the tab "Tools" and then "Firmware Download".




**Figure 69: Open the window Firmware Download**

A new window appears:



**Figure 70: Start of a Firmware Download**

When you press the button , you will have access to all directories to which your computer has access. Browse and select the appropriate firmware file; the file name must be "\*\*\*\*.srec".

Activating "Start" will start the download; please follow the instructions given by this program.

After completion, the RSM 200 is ready for use to you again; the "old" parameterization is retained. If necessary or if required, however, you must make adjustments.

## L Certificates and approvals

The RSM 200 is approved for custody transfer measurements. In this section you will find the declaration of conformity and the following certificates are actually available:

1. EU-Declaration of Conformity
2. ATEX-Certificate: EU-Type Examination Certificate acc. to Directive 2014/34/EU
3. IECEx-Certificate: Certificate of conformity
4. PED-Certificate: EU-Type Examination Certificate acc. to Directive 2014/68/EU

### For Isolating Amplifier type Ex 400

5. ATEX-Certificate: EU-Type Examination Certificate acc. to Directive 2014/34/EU

#### Note

##### EU Declaration of Conformity

The listed declaration of conformity reflects the status on the date of issue of the operating instructions. The latest version of the EU Declaration of Conformity is available on our website [www.rmg.com](http://www.rmg.com).

**EU-Declaration of Conformity**  
**EU-Konformitätserklärung**



We **RMG Messtechnik GmbH**  
 We Otto – Hahn – Straße 5  
 35510 Butzbach  
 Germany

Declare under our sole responsibility that the product is in conformity with the directives. Product is labeled according to the listed directives and standards and in accordance with the Type-Examination.

Erklären in alleiniger Verantwortung, dass das Produkt konform ist mit den Anforderungen der Richtlinien. Das entsprechend gekennzeichnete Produkt ist nach den aufgeführten Richtlinien und Normen hergestellt und stimmt mit dem Baumuster überein.

Product **Ultrasonic Gas Flowmeter type RSM 200**  
 Produkt **Ultraschallgaszähler Typ RSM 200**

Harmonisation Legislations Harmonisierungsrechtsvorschriften	EMV	ATEX	PED	MID
<b>EU- Directives</b> EU-Richtlinie	2014/30/EU	2014/34/EU	2014/68/EU	
<b>Marking</b> Kennzeichen	—	II 2G Ex ia IIC T4 Gb	—	
<b>Normative Documents</b> Normative Dokumente	EN 61000-6-3:2020 EN 61000-4-2:2009 EN 61000-4-3:2020 EN 61000-4-4:2013 EN 61000-4-5:2019 EN 61000-4-6:2014 EN 61000-4-6:2010 EN 61000-4-17:2005 EN 61000-4-29:2001 OIML R 137-2 in parts	EN 60079-0: 2018 EN 60079-11: 2012	AD 2000 – Merblätter	
<b>EU Type-Examination issued by</b> EU-Baumusterprüfung ausgestellt durch	Prüfbericht/ Test Report: 1-5688/23-01-02 CTC advanced GmbH Germany	Modul B BVS 23 ATEX E 019 X DEKRA Testing and Certification GmbH Germany	Modul B ISG-23-23-1042 Rev.03 TÜV Hessen Germany	
<b>Approval of a Quality System by</b> Anerkennung eines Qualitätssicherungssystems durch	—	Modul D BVS 20 ATEX ZGS/E139 Notified Body: 0158 DEKRA Testing and Certification GmbH Germany	Modul D 73 202 2839 Notified Body: 0091 TÜV Hessen Germany	



The object of the declaration described above is in conformity with Directive 2011/65/EU of the European Parliament and of the Council of 8 June 2011 on the restriction of the use of certain hazardous substances in electrical and electronic equipment.

Der oben beschriebene Gegenstand der Erklärung erfüllt die Vorschriften der Richtlinie 2011/65/EU des Europäischen Parlaments und des Rates vom 8. Juni 2011 zur Beschränkung der Verwendung bestimmter gefährlicher Stoffe in Elektro- und Elektronikgeräten.

**RMG Messtechnik GmbH**  
 Butzbach, den 10.04.2024

Thorsten Dietz, Managing director

Sascha Körner, Technical Manager



Translation

# EU-Type Examination Certificate

Directive 2014/34/EU of the European Parliament and of the Council of 26 February 2014

EU-Type Examination Certificate Number: **BVS 23 ATEX E 019 X** Issue: **00**

Equipment: **Ultrasonic Gas Meter type RSM 200-AA-BB C-DD-EE F**

Manufacturer: **RMG Messtechnik GmbH**

Address: **Otto-Hahn-Straße 5, 35510 Butzbach, Germany**

This product and any acceptable variations thereto are specified in the appendix to this certificate and the documents referred to therein.

DEKRA Testing and Certification GmbH, Notified Body number 0158, in accordance with Article 17 of Directive 2014/34/EU of the European Parliament and of the Council, dated 26 February 2014, certifies that this product has been found to comply with the Essential Health and Safety Requirements relating to the design and construction of products intended for use in potentially explosive atmospheres given in Annex II to the Directive.  
The examination and test results are recorded in the confidential Report No. BVS PP 23.2045 EU.

Compliance with the Essential Health and Safety Requirements has been assured by compliance with:

<b>EN IEC 60079-0:2018</b>	<b>General requirements</b>
<b>EN 60079-11:2012</b>	<b>Intrinsic Safety "I"</b>

If the sign "X" is placed after the certificate number, it indicates that the product is subject to the "Specific Conditions of Use" listed under item 17 of this certificate.

This EU-Type Examination Certificate relates only to the technical design of the specified product in accordance to the Directive 2014/34/EU. Further requirements of the Directive apply to the manufacturing process and supply of this product. These are not covered by this certificate.

The marking of the product shall include the following

**II 2G Ex Ia IIC T4 Gb**

DEKRA Testing and Certification GmbH  
Bochum, 2023-07-13

Signed: Oliver Brumm  
\_\_\_\_\_  
Managing Director



Page 1 of 5 of BVS 23 ATEX E 019 X Issue 00 – Jobnumber A 20200604 / 341933800  
This certificate may only be reproduced in its entirety and without any change.

DEKRA Testing and Certification GmbH, Handwerkerstr. 15, 70565 Stuttgart, Germany  
Certification body: Dinnendahlstr. 5, 44809 Bochum, Germany  
Phone +49.234.3696-400, Fax +49.234.3696-401, e-mail DTC-Certification-body@dekra.com







13 Appendix

14 EU-Type Examination Certificate

BVS 23 ATEX E 019xxx X Issue 00

15 Product description

15.1 Subject and type

Ultrasonic Gas Meter type RSM 200-AA-BB C-DD-EE F

<b>Model name</b>	RSM 200	- AA	- BB	C	- DD	- EE	F
<b>Volume conversion</b>							
Gas flow meter		VM					
Gas flow meter with P and T conversion		VC					
Gas flow meter with T conversion		VT					
<b>Nominal diameter (inch) (not critical to certification)</b>							
DN50 (2")			02				
DN80 (3")			03				
DN100 (4")			04				
DN150 (6")			06				
DN200 (8")			08				
<b>Material of meter body</b>							
Aluminum				A			
Ductile cast iron				D			
Steel				C			
<b>Hazardous location classification</b>							
none					00		
Zone 1					01		
Division 1					11		
<b>Power</b>							
Battery						P1	
IS Power supply / Battery						P2	
IS Power supply (only)						P3	
<b>RS485 interface</b>							
External powered							E
External powered low voltage							L

15.2 Description

The ultrasonic gas meter Type RSM200 is used for gas flow measurement. The apparatus is suitable for use in hazardous areas requiring EPL Gb. It is powered with internal batteries and/or an external power source.

The battery must not be replaced if an explosive atmosphere is present.

The ultrasonic transducer connections as well as all interface connections are intrinsically safe. The apparatus is an intrinsically safe electrical equipment and has been tested according to the requirements of IEC 60079-0 and IEC 60079-11. The suitability of the input circuit of the unit as an overvoltage protection device according to 60079-25 is not the subject of this certificate but requires further consideration.



Page 2 of 5 of BVS 23 ATEX E 019 X Issue 00 – Jobnumber A 20200604 / 341803800  
This certificate may only be reproduced in its entirety and without any change.

DEKRA Testing and Certification GmbH, Handwerkerstr. 15, 70565 Stuttgart, Germany  
Certification body: Dinnendahlstr. 6, 44809 Bochum, Germany  
Phone +49.234.3696-400, Fax +49.234.3696-401, e-mail DTC-Certification-body@dekra.com





### 15.3 Parameters

#### 15.3.1 Electrical parameters

Backup-Power Supply  
Battery Power Supply 2 (Terminal X13A 1(+) / 2(-))  
Maximum Input power  $P_i$  545.5 mW

Primary Power Supply  
External Power Supply or Battery Power Supply 1 (Terminal X5 1(+) / 2(-))  
Maximum Input voltage  $U_i$  11.2 V  
Maximum Input current  $I_i$  122 mA  
Maximum Input power  $P_i$  550 mW

External Power Supply  
Maximum internal capacitance  $C_i$  negligible  
Maximum internal inductance  $L_i$  0.253 mH

Primary Power Supply  
Only External Power Supply (Terminal X5 1(+) / 2(-))  
Maximum Input voltage  $U_i$  11.2 V  
Maximum Input current  $I_i$  322 mA  
Maximum Input power  $P_i$  1100 mW

External Power Supply  
Maximum internal capacitance  $C_i$  negligible  
Maximum internal inductance  $L_i$  0.253 mH

Digital output DO1; optically isolated (Terminal X20 1(+) / 2(-))  
Maximum Input voltage  $U_i$  20 V  
Maximum Input current  $I_i$  50 mA  
Maximum Input power  $P_i$  660 mW  
Maximum internal capacitance  $C_i$  negligible  
Maximum internal inductance  $L_i$  negligible

Digital output DO2; optically isolated (Terminal X19 1(+) / 2(-))  
Maximum Input voltage  $U_i$  20 V  
Maximum Input current  $I_i$  50 mA  
Maximum Input power  $P_i$  660 mW  
Maximum internal capacitance  $C_i$  negligible  
Maximum internal inductance  $L_i$  negligible

Digital output DO3; optically isolated (Terminal X18 1(+) / 2(-))  
Maximum Input voltage  $U_i$  20 V  
Maximum Input current  $I_i$  50 mA  
Maximum Input power  $P_i$  660 mW  
Maximum internal capacitance  $C_i$  negligible  
Maximum internal inductance  $L_i$  negligible

Digital output DO4; optically isolated (Terminal X17 1(+) / 2(-))  
Maximum Input voltage  $U_i$  20 V  
Maximum Input current  $I_i$  50 mA  
Maximum Input power  $P_i$  660 mW  
Maximum internal capacitance  $C_i$  negligible  
Maximum internal inductance  $L_i$  negligible



Page 3 of 5 of BVS 23 ATEX E 019 X Issue 00 – Jobnumber A 20200604 / 341933600  
This certificate may only be reproduced in its entirety and without any change.

DEKRA Testing and Certification GmbH, Handwerkerstr. 15, 70565 Stuttgart, Germany  
Certification body: DINWendelstr. 9, 44809 Bochum, Germany  
Phone +49.234.3696-400, Fax +49.234.3696-401, e-mail DTC-Certification-body@dekra.com



Pressure Transmitter Power Supply terminal X15A 1(+)/2(-)

Maximum output voltage	$U_o$	7.13	V
Maximum external inductance	$L_o$	0.015	mH

Pressure Transmitter Communication / Data terminal X15B 1(+)/2(-)

Maximum output voltage	$U_o$	7.13	V
Maximum external inductance	$L_o$	0.015	mH

Temperature Transmitter Power Supply terminal X16A 1(+)/2(-)

Maximum output voltage	$U_o$	7.13	V
Maximum external inductance	$L_o$	0.015	mH

Temperature Transmitter Communication / Data terminal X16B 1(+)/2(-)

Maximum output voltage	$U_o$	7.13	V
Maximum external inductance	$L_o$	0.015	mH

The following parameters apply to the four terminals X15A; X15B; X16A; X16B:

Maximum output current	$I_o$	$\Sigma 2.2$	A
Maximum output power	$P_o$	$\Sigma 1.0$	W
Maximum external capacitance	$C_o$	$\Sigma 6200$	nF

RS485 interface:

RS485 data (Terminal X21A 1(A) / 2(B))

Maximum input voltage	$U_i$	8	V
Maximum input current	$I_i$	135	mA
Maximum input power	$P_i$	450	mW
Maximum internal capacitance	$C_i$	1488	nF
Maximum internal inductance	$L_i$	negligible	

Only for RSM200-xx-xx x-xx-xx E

RS485; power supply (Terminal X21B 1(+)/2(-))

Maximum input voltage	$U_i$	11.2	V
Maximum input current	$I_i$	135	mA
Maximum input power	$P_i$	450	mW
Maximum internal capacitance	$C_i$	negligible	
Maximum internal inductance	$L_i$	negligible	

The sum current and sum power of the two intrinsically safe circuits (RS485 terminal X21A&B) is limited to the following values:

Maximum input current	$I_i$	270	mA
Maximum input power	$P_i$	900	mW

Only for RSM200-xx-xx x-xx-xx L

RS485; low voltage (Terminal X21B 1(+)/2(-))

Maximum input voltage	$U_i$	3.6	V
Maximum input current	$I_i$	135	mA
Maximum input power	$P_i$	450	mW
Maximum internal capacitance	$C_i$	145	nF
Maximum internal inductance	$L_i$	negligible	

The sum current and sum power of the two intrinsically safe circuits (RS485 terminal X21A&B) is limited to the following values:

Maximum input current	$I_i$	270	mA
Maximum input power	$P_i$	900	mW

15.3.2 Rated ambient temperature range with Batteries without Batteries

$T_a$	$-40\text{ °C} \leq T_a \leq +60\text{ °C}$
	$-40\text{ °C} \leq T_a \leq +70\text{ °C}$



**16 Report Number**  
BVS PP 23.2045 EU, as of 2023-07-13

**17 Specific Conditions of Use**

- The maximum piezo-electric energy released by impact on the ultrasonic sensors exceeds the limit for Gas Group IIC specified in Clause 10.7 of IEC 60079-11:2011. Therefore, mechanical impact shall be avoided during installation.
- The breakdown voltage between the intrinsically safe circuit and the earth connection is less than 500 VAC due to the design. The intrinsically safe circuit must be considered earthed. Equipotential bonding must be provided at the installation site.

**18 Essential Health and Safety Requirements**  
Met by compliance with the requirements mentioned in item 9.

**19 Remarks and additional information**  
Drawings and documents are listed in the confidential report.

---

We confirm the correctness of the translation from the German original.  
In the case of arbitration only the German wording shall be valid and binding.

DEKRA Testing and Certification GmbH  
Bochum, 2023-07-13  
BVS-Hrh/MGR A 20200804 / 341933800

\_\_\_\_\_  
Managing Director

Page 5 of 5 of BVS 23 ATEX E 019 X Issue 00 – Jobnumber A 20200804 / 341933800  
This certificate may only be reproduced in its entirety and without any change.

DEKRA Testing and Certification GmbH, Handwerkstr. 15, 70565 Stuttgart, Germany  
Certification body: Dinnendahlstr. 9, 44809 Bochum, Germany  
Phone +49.234.3696-400, Fax +49.234.3696-401, e-mail DTG-Certification-body@dekra.com



# IECEX Certificate of Conformity

INTERNATIONAL ELECTROTECHNICAL COMMISSION  
IEC Certification System for Explosive Atmospheres

for rules and details of the IECEX Scheme visit [www.iecex.com](http://www.iecex.com)

Certificate No.:	IECEX BVS 23.0011X	Page 1 of 3	<a href="#">Certificate history:</a>
Status:	Current	Issue No: 0	
Date of Issue:	2023-07-14		
Applicant:	RMG Messtechnik GMBH Otto Hahn Strasse 5 35510 Butzbach Germany		
Equipment:	Ultrasonic Gas Meter		
Optional accessory:			
Type of Protection:	Intrinsic Safety "I"		
Marking:	Ex ia IIC T4 Gb		

Approved for issue on behalf of the IECEX  
Certification Body:

Dr Franz Eickhoff

Position:

Senior Lead Auditor, Certification Manager and officially  
recognised expert

Signature:  
(for printed version)

Date:  
(for printed version)

2023-07-14


1. This certificate and schedule may only be reproduced in full.
2. This certificate is not transferable and remains the property of the issuing body.
3. The Status and authenticity of this certificate may be verified by visiting [www.iecex.com](http://www.iecex.com) or use of this QR Code.



Certificate issued by:

**DEKRA Testing and Certification GmbH**  
Certification Body  
Dinnendahlstrasse 9  
44809 Bochum  
Germany



		<h2>IECEX Certificate of Conformity</h2>	
Certificate No.:	IECEX BVS 23.0011X	Page 2 of 3	
Date of issue:	2023-07-14	Issue No: 0	
Manufacturer:	RMG Messtechnik GMBH Otto Hahn Strasse 5 35510 Butzbach Germany		
Manufacturing locations:	RMG Messtechnik GMBH Otto Hahn Strasse 5 35510 Butzbach Germany		
<p>This certificate is issued as verification that a sample(s), representative of production, was assessed and tested and found to comply with the IEC Standard list below and that the manufacturer's quality system, relating to the Ex products covered by this certificate, was assessed and found to comply with the IECEX Quality system requirements. This certificate is granted subject to the conditions as set out in IECEX Scheme Rules, IECEX 02 and Operational Documents as amended</p>			
<p><b>STANDARDS :</b>          The equipment and any acceptable variations to it specified in the schedule of this certificate and the identified documents, was found to comply with the following standards</p>			
IEC 60079-0:2017 Edition:7.0	Explosive atmospheres - Part 0: Equipment - General requirements		
IEC 60079-11:2011 Edition:6.0	Explosive atmospheres - Part 11: Equipment protection by intrinsic safety "I"		
<p>This Certificate does not indicate compliance with safety and performance requirements other than those expressly included in the Standards listed above.</p>			
<p><b>TEST &amp; ASSESSMENT REPORTS:</b>          A sample(s) of the equipment listed has successfully met the examination and test requirements as recorded in:</p>			
<p>Test Report:          DE/BVS/ExTR23.0020/00</p>			
<p>Quality Assessment Report:          DE/BVS/QAR08.0011/10</p>			



## IECEx Certificate of Conformity

Certificate No.: IECEx BVS 23.0011X

Page 3 of 3

Date of issue: 2023-07-14

Issue No: 0

**EQUIPMENT:**

Equipment and systems covered by this Certificate are as follows:

**General product information:**

The ultrasonic gas meter Type RSM200 is used for gas flow measurement. The apparatus is suitable for use in hazardous areas requiring EPL Gb. It is powered with internal batteries and/or an external power source. The battery must not be replaced if an explosive atmosphere is present.

The ultrasonic transducer connections as well as all interface connections are intrinsically safe. The apparatus is an intrinsically safe electrical equipment and has been tested according to the requirements of IEC 60079-0 and IEC 60079-11. The suitability of the input circuit of the unit as an overvoltage protection device according to 60079-25 is not the subject of this certificate but requires further consideration.

**Type code:**

See Annex

**SPECIFIC CONDITIONS OF USE: YES as shown below:**

- The maximum piezo-electric energy released by impact on the ultrasonic sensors exceeds the limit for Gas Group IIC specified in Clause 10.7 of IEC 60079-11:2011. Therefore, mechanical impact shall be avoided during installation.
- The breakdown voltage between the intrinsically safe circuit and the earth connection is less than 500 VAC due to the design. The intrinsically safe circuit must be considered earthed. Equipotential bonding must be provided at the installation site.

**Annex:**

BVS\_23\_0011X\_RMG\_Annex.pdf



# IECEx Certificate of Conformity



Certificate No.: IECEx BVS 23.0011X Issue No. 0  
 Annex  
 Page 1 of 3

Type code:

<b>Model name</b>	RSM 200	- AA	- BB	C	- DD	- EE	F
<b>Volume conversion</b>							
Gas flow meter		VM					
Gas flow meter with P and T conversion		VC					
Gas flow meter with T conversion		VT					
<b>Nominal diameter (inch) (not critical to certification)</b>							
DN50 (2")			02				
DN80 (3")			03				
DN100 (4")			04				
DN150 (6")			06				
DN200 (8")			08				
<b>Material of meter body</b>							
Aluminum				A			
Ductile cast iron				D			
Steel				C			
<b>Hazardous location classification</b>							
none					00		
Zone 1					01		
Division 1					11		
<b>Power</b>							
Battery						P1	
IS Power supply / Battery						P2	
IS Power supply (only)						P3	
<b>RS485 interface</b>							
External powered							E
External powered low voltage							L

Electrical parameter:

The apparatus is powered by an external power source. Or optionally powered by a battery supply 1 and/or a battery supply 2 or an external power source and battery supply 1.

Backup Power Supply

Battery Power Supply 2 (terminal X13 1(+) / 2(-))

Maximum input power  $P_i$  545.5 mW

Primary Power Supply

External Power Supply or Battery Power Supply 1 (terminal X5 1(+) / 2(-))

Maximum input voltage  $U_i$  11.2 V

Maximum input current  $I_i$  122 mA

Maximum input power  $P_i$  550 mW

External Power Supply

Maximum internal capacitance  $C_i$  negligible

Maximum internal inductance  $L_i$  0.253 mH





## IECEX Certificate of Conformity



**Certificate No.:** IECEx BVS 23.0011X Issue No. 0  
**Annex**  
 Page 2 of 3

**Primary Power Supply**

Only External Power Supply (terminal X5 1(+) / 2(-))

Maximum input voltage	$U_i$	11.2 V
Maximum input current	$I_i$	322 mA
Maximum input power	$P_i$	1100 mW
Maximum internal capacitance	$C_i$	negligible
Maximum internal inductance	$L_i$	0.253 mH

Digital output DO1; optically isolated (terminal X20 1(+) / 2(-))

Maximum input voltage	$U_i$	20 V
Maximum input current	$I_i$	50 mA
Maximum input power	$P_i$	660 mW
Maximum internal capacitance	$C_i$	negligible
Maximum internal inductance	$L_i$	negligible

Digital output DO2; optically isolated (terminal X19 1(+) / 2(-))

Maximum input voltage	$U_i$	20 V
Maximum input current	$I_i$	50 mA
Maximum input power	$P_i$	660 mW
Maximum internal capacitance	$C_i$	negligible
Maximum internal inductance	$L_i$	negligible

Digital output DO3; optically isolated (terminal X18 1(+) / 2(-))

Maximum input voltage	$U_i$	20 V
Maximum input current	$I_i$	50 mA
Maximum input power	$P_i$	660 mW
Maximum internal capacitance	$C_i$	negligible
Maximum internal inductance	$L_i$	negligible

Digital output DO4; optically isolated (terminal X17 1(+) / 2(-))

Maximum input voltage	$U_i$	20 V
Maximum input current	$I_i$	50 mA
Maximum input power	$P_i$	660 mW
Maximum internal capacitance	$C_i$	negligible
Maximum internal inductance	$L_i$	negligible

Pressure Transmitter Power Supply terminal X15A 1(+)/2(-)

Maximum output voltage	$U_o$	7.13 V
Maximum external inductance	$L_o$	0.015 mH

Pressure Transmitter Communication / Data terminal X15B 1(+)/2(-)

Maximum output voltage	$U_o$	7.13 V
Maximum external inductance	$L_o$	0.015 mH



## IECEX Certificate of Conformity



Certificate No.: **IECEX BVS 23.0011X Issue No. 0**  
**Annex**  
 Page 3 of 3

Temperature Transmitter Power Supply terminal X16A 1(+)/2(-)

Maximum output voltage	$U_o$	7.13	V
Maximum external inductance	$L_o$	0.015	mH

Temperature Transmitter Communication / Data terminal X16B 1(+)/2(-)

Maximum output voltage	$U_o$	7.13	V
Maximum external inductance	$L_o$	0.015	mH

The following parameters apply to the four terminals X15A; X15B; X16A; X16B:

Maximum output current	$I_o$	$\sum$	2.2	A
Maximum output power	$P_o$	$\sum$	1.0	W
Maximum external capacitance	$C_o$	$\sum$	6200	nF

RS485 interface:

RS485 data (terminal X21A 1(A) / 2(B))

Maximum input voltage	$U_i$	8	V
Maximum input current	$I_i$	135	mA
Maximum input power	$P_i$	450	mW
Maximum internal capacitance	$C_i$	1488	nF
Maximum internal inductance	$L_i$		negligible

Only for RSM200-xx-xx x-xx-xx E

RS485; power supply (terminal X21B 1(+)/2(-))

Maximum input voltage	$U_i$	11.2	V
Maximum input current	$I_i$	135	mA
Maximum input power	$P_i$	450	mW
Maximum internal capacitance	$C_i$		negligible
Maximum internal inductance	$L_i$		negligible

The sum current and sum power of the two intrinsically safe circuits (RS485 terminal X21A&B) is limited to the following values:

Maximum input current	$I_i$	270	mA
Maximum input power	$P_i$	900	mW

Only for RSM200-xx-xx x-xx-xx L

RS485; low voltage (terminal X21B 1(+)/2(-))

Maximum input voltage	$U_i$	3.6	V
Maximum input current	$I_i$	135	mA
Maximum input power	$P_i$	450	mW
Maximum internal capacitance	$C_i$	145	nF
Maximum internal inductance	$L_i$		negligible

The sum current and sum power of the two intrinsically safe circuits (RS485 terminal X21A&B) is limited to the following values:

Maximum input current	$I_i$	270	mA
Maximum input power	$P_i$	900	mW

**TÜV Technische Überwachung Hessen GmbH**

Industrie Service  
Hans - Böckler - Straße 4  
Telefon: 06403 / 9008 - 0

35440 Linden  
Fax: 06403 / 9008 - 20



# ZERTIFIKAT

(EU-BAUMUSTERPRÜFBESCHEINIGUNG FÜR BAUMUSTER)  
(EU-type examination certificate – production type)

EU-Baumusterprüfung (Modul B für Baumuster) nach Richtlinie 2014/68/EU  
EU-type examination (Module B - production type) according to directive 2014/68/EU

**Zertifikat – Nr.: ISG-22-23-1042\_Rev. 01**

**Name und Anschrift des Herstellers:** RMG Messtechnik GmbH  
Otto-Hahn-Strasse 5  
**Name and postal address of the manufacturer:** D-35510 Butzbach

**Hiermit wird bestätigt, dass das unten genannte Baumuster die Anforderungen der Richtlinie 2014/68/EU erfüllt.**

We herewith certify that the type mentioned below meets the requirements of the directive 2014/68/EU.

**Prüfbericht – Nr.:** siehe Beiblätter zu/ see attached sheet: ISG-22-23-1042\_Rev. 01  
**Test report No.:**

**Bezeichnung:** Ultraschallgaszähler RSM 200  
**Designation:** DN100, DN150, DN200

**Geltungsbereich:** Ultraschallgaszähler RSM 200  
**Scope of examination:** siehe Anhang zu / see attached sheet to: ISG-22-23-1042\_Rev. 01

**Prüfobjekt:** druckhalt. Ausrüstungsteil (pressure accessory)  
**Inspection item:**

**Kategorie:** I - III  
**Category:**

**Fertigungsstätte:** Otto-Hahn-Str. 5, D-35510 Butzbach  
**Manufacturing plant:**

**Gültig bis:** siehe Anhang zu/ see attached sheet to: ISG-22-23-1042\_Rev. 01  
**Valid:**

**Bemerkungen / Hinweise:**  Das Zertifikat ISG-22-23-1042\_Rev. -- vom 14.09.2023 ist hiermit ersetzt und verliert seine Gültigkeit! / The certificate ISG-22-23-1042\_Rev. -- dated 14.09.2023 is hereby replaced and loses its validity!  
**Remarks / hints:**  Die zulässigen Einsatztemperaturen der Ultraschallgaszähler sind der Entwurfsprüfung des Baumuster zu entnehmen. / The permitted operating temperatures of the ultrasonic gas meter shall be specified in the design approval of the EU-type.

**Anlagen:** siehe Beiblatt zu/ see attached sheet to: ISG-22-23-1042\_Rev. 01  
**documents:**

TÜV Technische Überwachung Hessen GmbH  
Notified body, No.: 0091

Linden, 24.01.2024  
place, date

Zertifizierer:



*[Handwritten Signature]*

Dietrich  S. Druß

Umseitige Hinweise beachten / see hints overleaf

ISG\_22\_23-1042\_REV\_01\_RM3\_B-8\_RSM\_200\_DN 80-200.Docx



## Translation

(1) **EU-Type Examination Certificate**

- (2) Equipment and protective systems intended for use in potentially explosive atmospheres, Directive 2014/34/EU



- (3) **Certificate Number** TÜV 17 ATEX 207696 **issue:** 00
- (4) for the product: Isolating Amplifier type Ex 400
- (5) of the manufacturer: RMG Messtechnik GmbH
- (6) Address: Otto-Hahn-Straße 5  
35510 Butzbach
- Order number: 8000476312
- Date of issue: 2019-09-16

- (7) The design of this product and any acceptable variation thereto are specified in the schedule to this EU-Type Examination Certificate and the documents therein referred to.
- (8) The TÜV NORD CERT GmbH, Notified Body No. 0044, in accordance with Article 17 of the Directive 2014/34/EU of the European Parliament and the Council of 26 February 2014, certifies that this product has been found to comply with the Essential Health and Safety Requirements relating to the design and construction of products intended for use in potentially explosive atmospheres given in Annex II to the Directive. The examination and test results are recorded in the confidential ATEX Assessment Report No. 19 203 207696.
- (9) Compliance with the Essential Health and Safety Requirements has been assured by compliance with:  
EN 60079-0:2012+A11:2013 EN 60079-11:2012  
except in respect of those requirements listed at item 18 of the schedule.
- (10) If the sign "X" is placed after the certificate number, it indicates that the product is subject to the Specific Conditions for Use specified in the schedule to this certificate.
- (11) This EU-Type Examination Certificate relates only to the design, and construction of the specified product. Further requirements of the Directive apply to the manufacturing process and supply of this equipment. These are not covered by this certificate.
- (12) The marking of the product shall include the following:

II (2) G [Ex ia Gb] IIC

TÜV NORD CERT GmbH, Langemarckstraße 20, 45141 Essen, notified by the central office of the countries for safety engineering (ZLS), Ident. Nr. 0044, legal successor of the TÜV NORD CERT GmbH & Co. KG Ident. Nr. 0032

The head of the notified body

Röder

Hanover office, Am TÜV 1, 30519 Hannover, Tel. +49 511 998-61455, Fax +49 511 998-61590

This certificate may only be reproduced without any change, schedule included.  
Excerpts or changes shall be allowed by the TÜV NORD CERT GmbH



(13) **SCHEDULE**

(14) **EU-Type Examination Certificate No. TÜV 17 ATEX 207696 issue 00**

(15) Description of product

The Isolating Amplifier type Ex 400 is an associated apparatus for the explosion hazardous area. It serves for the safe galvanic separation of no intrinsically safe circuits from the intrinsically safe circuits.

These are:

- Power supply
- RS 485 interface
- Digital IO circuits
- Current loop interface

2 variants are available:

- A: For mounting in a cabinet as hat rail module
- B: For mounting on a wall in a closed housing

The permissible ambient temperature range is -40 °C ... 60 °C.

Electrical data

Supply circuit ..... U = 24 V d. c.  $\pm 15\%$ ,  $I_{max} = 340$  mA  
(Terminal X1; 3[+], 2[0 V], 1[shield] )  $U_m = 250$  V a. c.

Data circuits;  
1xDigital-in, 3xDigital-out ..... R485 interface  
(Terminal X5, 1 ... 6, 7[shield] ) U = 5-24 V d. c.,  $I_{max} = 50$  mA,  $P_{max} = 250$  mW  
 $f_{max} = 1$  kHz  
 $U_m = 250$  V a. c.

RS485 interface ..... U = 5 V, I = 18 mA  
(Terminal X3, 1 ... 5, 6[shield] )  $U_m = 250$  V a. c.

Current loop ..... I = 0/4-25 mA,  $R_b = 250 \Omega$   
(Terminal X7, 1 and 2, 3[shield] )  $U_m = 250$  V a. c.

Ex-i supply circuit ..... in type of protection Intrinsic Safety Ex ia IIC  
(Terminal X2; 1[+], 2[0 V], 3[shield] ) Maximum values:  
 $U_o = 10.7$  V  
 $I_o = 122$  mA  
 $P_o = 325$  mW  
Characteristic line: linear  
The effective internal capacitances and inductances are negligibly small.

Ex ia	IIC		
max. permissible external inductance	2 mH	1 mH	0.2 mH
max. permissible external capacitance	540 nF	750 nF	1300 nF



**Schedule to EU-Type Examination Certificate No. TÜV 17 ATEX 20769 issue 00**

Ex Digital-in circuits ..... in type of protection Intrinsic Safety Ex ia IIC  
 (Terminal X6; 1-3, 5, 6[shield])  
 Sum of maximum values:  
 $U_o = 5.9 \text{ V}$   
 $I_o = 18 \text{ mA}$   
 $P_o = 27 \text{ mW}$   
 Characteristic line: linear  
 The effective internal capacitances and inductances are negligibly small.

Ex ia	IIC		
max. permissible external inductance	2 mH	1 mH	0.5 mH
max. permissible external capacitance	2400 nF	2800 nF	3300 nF

Ex Digital-out circuit ..... in type of protection Intrinsic Safety Ex ia IIC  
 (Terminal X6; 4, 5, 6[shield])  
 Maximum values:  
 $U_o = 5.9 \text{ V}$   
 $I_o = 3 \text{ mA}$   
 $P_o = 4.5 \text{ mW}$   
 Characteristic line: linear  
 The effective internal capacitances and inductances are negligibly small.

Ex ia	IIC		
max. permissible external inductance	2 mH	1 mH	0.5 mH
max. permissible external capacitance	2500 nF	2800 nF	3300 nF

Ex-i RS485 interface circuit ..... in type of protection Intrinsic Safety Ex ia IIC  
 (Terminal X4; 1[A+], 2[B-], 3[shield] )  
 Maximum values:  
 $U_o = 5.9 \text{ V}$   
 $I_o = 96 \text{ mA}$   
 $R = 148.5 \Omega$   
 $P_o = 193 \text{ mW}$   
 Characteristic line: trapezoidal  
 The effective internal inductances are negligibly small.  
 Effective internal capacitance: 332 nF

Ex ia	IIC		
max. permissible external inductance	2 mH	1 mH	0.5 mH
max. permissible external capacitance	1268 nF	1868 nF	2468 nF



**Schedule to EU-Type Examination Certificate No. TÜV 17 ATEX 20769 issue 00**

Ex Digital-in (PWM) circuit ..... in type of protection Intrinsic Safety Ex ia IIC  
 (Terminal X8; 1, 2, 3[shield])  
 Maximum values:  
 $U_o = 5.9 \text{ V}$   
 $I_o = 6 \text{ mA}$   
 $P_o = 9 \text{ mW}$   
 Characteristic line: linear  
 The effective internal capacitances and inductances are negligibly small.

Ex ia	IIC		
max. permissible external inductance	2 mH	1 mH	0.5 mH
max. permissible external capacitance	2500 nF	2800 nF	3300 nF

All maximum values  $L_o$  and  $C_o$  are also allowed to be utilized as concentrated capacitances and as concentrated inductances.

(16) Drawings and documents are listed in the ATEX Assessment Report No. 19 203 207696

(17) Specific Conditions for Use  
 -none-

(18) Essential Health and Safety Requirements  
 no additional ones

- End of Certificate -

## Contact

---

*Subject to technical changes*

### **More information**

If you would like to receive more information about the products and solutions of RMG visit our website:

[www.rmg.com](http://www.rmg.com)

or contact your local sales representative

### **RMG Messtechnik GmbH**

Otto-Hahn-Straße 5  
35510 Butzbach, Germany  
Phone: +49 (0) 6033 897 – 0  
Fax: +49 (0) 6033 897 – 130  
Email: [service@rmg.com](mailto:service@rmg.com)

