



INSTALLATION, OPERATION, AND MAINTENANCE MANUAL
WELKER INTELLISCENT™ ODORANT MONITOR



MANUAL NUMBER
IOM-228

REVISION
Rev. 0, 10/04/2019

TABLE OF CONTENTS

	SAFETY	4
1.	PRODUCT INFORMATION	5
1.1	Introduction	5
1.2	Product Description	5
1.3	Safety Warning and Important Information	5
1.4	Specifications	6
1.5	Equipment Diagrams	7
2.	INSTALLATION & OPERATION	9
2.1	Before You Begin	9
2.2	Principles of Operation	10
2.3	Installation	11
2.4	Start-Up Procedures	19
3.	USER INTERFACES	20
3.1	Understanding the Primary Display	20
3.2	Understanding the Gas Sensor Display	25
4.	CALIBRATION	26
4.1	Calibration Overview	26
4.2	Span Gas	26
4.3	Zero Gas	26
4.4	Connecting Calibration Gas to the IntelliScent™	27
4.5	Cal Span Value	28
4.6	System Calibration Overview	28
4.7	System Calibration Procedure – Cal Gas	30
4.8	System Calibration Procedure – Stream	31
4.9	Gas Sensor Calibration	32

5.	USER MENUS	34
5.1	IntelliScent™ User Menus	34
5.2	Gas Sensor User Menus	42
6.	MAINTENANCE	48
6.1	Before You Begin	48
6.2	Inspecting the Inlet Filter	48
6.3	Checking Flow Levels	48
6.4	Testing the Operation of Internal Components	49
6.5	Sensor Element Replacement	49
6.6	Hard Fault Conditions	50
6.7	Warning Conditions	51
6.8	Cold Weather Operation	51
6.9	Restore Factory Settings	52
6.10	Troubleshooting	53
	APPENDICES	56
	A: MODBUS Registers	56
	B: Gas Sensor Factory Default Setup	61
	C: System Events	64
	D: IntelliScent™ Application for iPhone	66

IMPORTANT SAFETY INFORMATION

READ ALL INSTRUCTIONS



Notes emphasize information and/or provide additional information to assist the user.



Caution messages appear before procedures that could result in damage to equipment if not observed.



Warning messages appear before procedures that could result in personal injury if not observed.

This manual is intended to be used as a basic installation and operation guide for the Welker OdorEyes IntelliScent™ Odorant Monitor.

The information in this manual has been carefully checked for accuracy and is intended to be used as a guide for the installation, operation, and maintenance of the Welker OdorEyes equipment described in this manual. Correct installation and operation, however, are the responsibility of the end user. Welker reserves the right to make changes to this manual and all products in order to improve performance and reliability.

BEFORE YOU BEGIN

Read these instructions completely and carefully.

IMPORTANT – Save these instructions for local inspector’s use.

IMPORTANT – Observe all governing codes and ordinances.

Note to Installer – Leave these instructions with the end user.

Note to End User – Keep these instructions for future reference.

Installation of this IntelliScent™ Odorant Monitor is of a mechanical and electrical nature.

Proper installation is the responsibility of the installer. Product failure due to improper installation is not covered under the warranty.

If you received a damaged IntelliScent™ Odorant Monitor, please contact a Welker representative immediately.

Phone: 281.491.2331

Address: 13839 West Bellfort Street
Sugar Land, TX 77498

1.1 Introduction

We appreciate your business and your choice of Welker products. The installation, operation, and maintenance liability for this equipment becomes that of the purchaser at the time of receipt. Reading the applicable *Installation, Operation, and Maintenance (IOM) Manuals* prior to installation and operation of this equipment is required for a full understanding of its application and performance prior to use.*

If you have any questions, please call Welker at 1-281-491-2331.

**The following procedures have been written for use with standard Welker OdorEyes parts and equipment. Assemblies that have been modified may have additional requirements and specifications that are not listed in this manual.*

1.2 Product Description

The Welker OdorEyes IntelliScent™ Odorant Monitor is designed to provide a safe and reliable way to measure the levels of mercaptan, THT, and mixed odorants in streams of natural gas. The IntelliScent™ is designed for unattended operation and can measure odorant in the range of 0–50 milligrams per cubic meter (mg/m³) or 0–3 pounds per million cubic feet (lb/MMcf).

The completely automated measurement cycle eliminates human error and produces an accurate reading that can be repeated at one-, two-, four-, six-, eight-, twelve-, or twenty-four-hour intervals. The IntelliScent™ contains multiple microprocessor controllers that manage the measurement cycle and automatically detect and report system errors, such as blocked flow, expired sensor elements, or over-range inputs.

The IntelliScent™ offers 4–20 mA analog output and serial RS-485 MODBUS output. An extensive MODBUS database allows remote users to access system status, measurement data, calibration data, and more.

In addition to fully autonomous operation, the IntelliScent™ can be programmed for periodic automatic calibration using a separate cal gas inlet port and locally connected bottle of calibration gas. Automatic calibration can be programmed to occur at daily, weekly, monthly, or quarterly intervals.

Remotely interrogate and command the IntelliScent™ from up to twenty-five feet (25 ft) away using an iOS wireless application (IntelliScent™ iOS app) available from the Apple App Store. Security settings allow both MODBUS and wireless communications to be enabled, restricted to read-only or totally disabled.

The IntelliScent™ is designed for use in Class I, Division 1 hazardous areas and is constructed using stainless steel tubing and fittings, explosion-proof enclosures, and high-quality industrial components. The IntelliScent™ utilizes an industry-recognized gas sensor for real-time measurement of the amount of odorant present in the natural gas stream.

Welker may custom design the IntelliScent™ Odorant Monitor to suit the particular application and specifications of each customer.

1.3 Safety Warning and Important Information

The IntelliScent™ is designed for use in hazardous areas. Installation in these areas should follow best industry standard practices and all appropriate electrical codes. Generally, these codes require rigid metal conduit, poured seals, and other installation elements necessary to ensure safety. For maximum protection against RF interference or electrical surge, the IntelliScent™ back panel and interconnecting conduit must be properly grounded.

The IntelliScent™ is not designed or certified for use as an intrinsically safe device.

1.4 Specifications



The specifications listed in this section are generalized for this equipment. Welker can modify the equipment according to your company's needs. **Please note that the specifications may vary depending on the customization of your equipment.**

Table 1: IntelliScent™ Specifications

Application	Monitoring Odorant Levels in Natural Gas Systems
Materials of Construction	Instrument Housings: Aluminum Tubing & Fittings: 316 Stainless Steel
Maximum Allowable Operating Pressure	1500 psig @ 32 °F to 122 °F (103 barg @ 0 °C to 50 °C)
Temperature Range	-4 °F to 122 °F (-20 °C to 50 °C)
Power	DC 12 V ± 5% @ < 12 W 200 W @ AC 110 V (Optional Heater)
Analog Output	4–20mA, 750 Ω Loop Resistance
Digital Output	R-485 2-Wire MODBUS
Connections	Calibration Gas Inlet: ¼" NPT Filter Drain: ¼" NPT Purge Air Inlet: ¼" NPT Sample Exhaust: ¼" NPT Sample Inlet: ¼" NPT
Utility Requirements	Ambient Air for Purge Temperature Range: 14 °F to 104 °F (-10 °C to 40 °C) Humidity Range: 10–95% RH, Non-Condensing
Electrical Connection	DC 24 V, 4–20 mA
Sample Rate	Up to 24 Samples Per Day at 1-Hour Intervals
Enclosure Dimensions	24" x 24" x 8" (Length x Width x Depth)
Features	Coalescing Filter High Resolution Color LCD Display with Engineering Units, Bar Graph, and 30-Minute Trend iOS Wireless Application Onboard Non-Volatile Memory
Electrical Area Classification	CSA Class I, Div. 1, Groups B, C, and D
Options	Enclosure Material Insulated Enclosure Insulated and Heated Enclosure Sensor Type

1.5 Equipment Diagrams

Figure 1: IntelliScent™ Connections Diagram

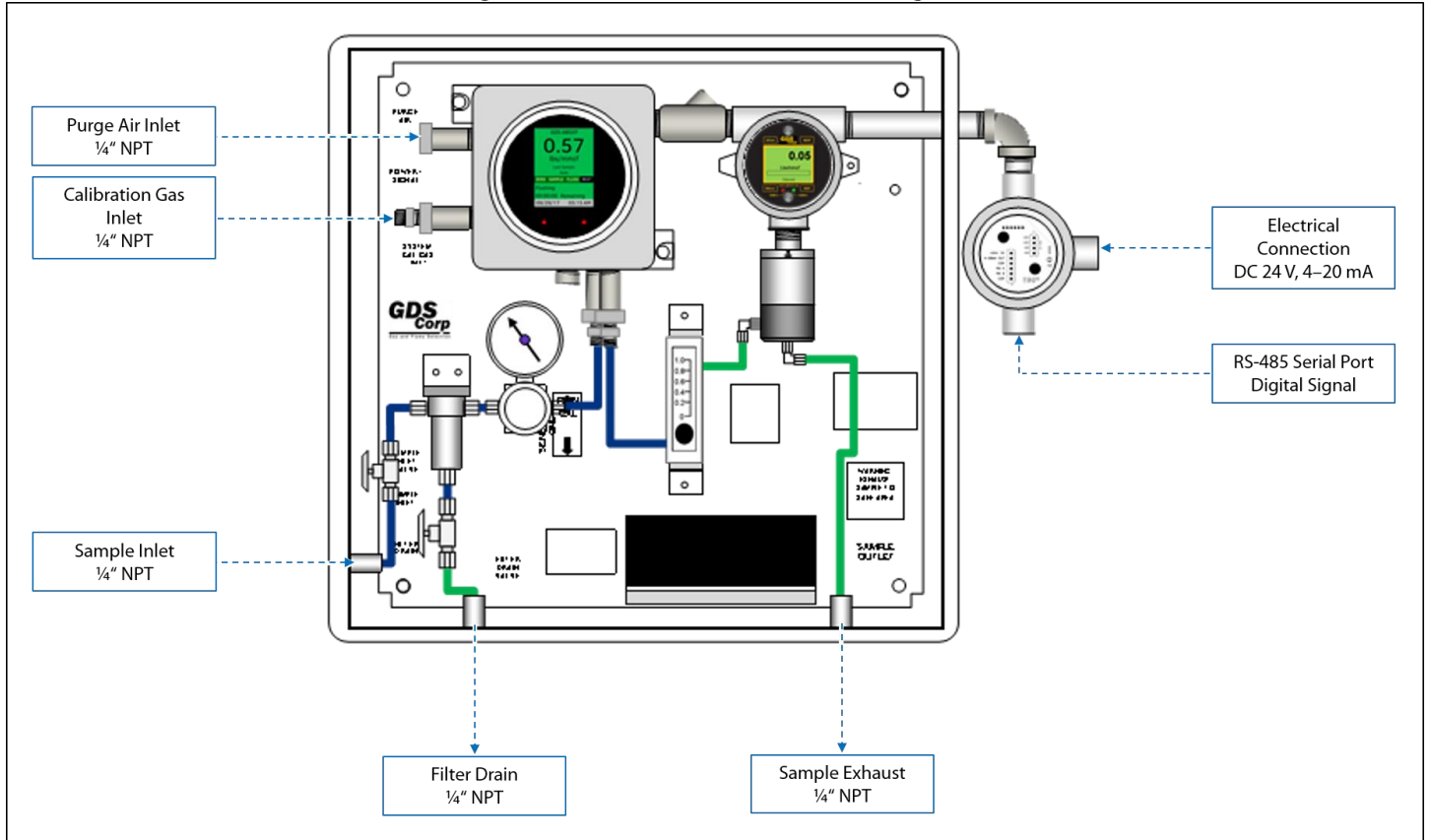

Figure 2: IntelliScent™ Main Components

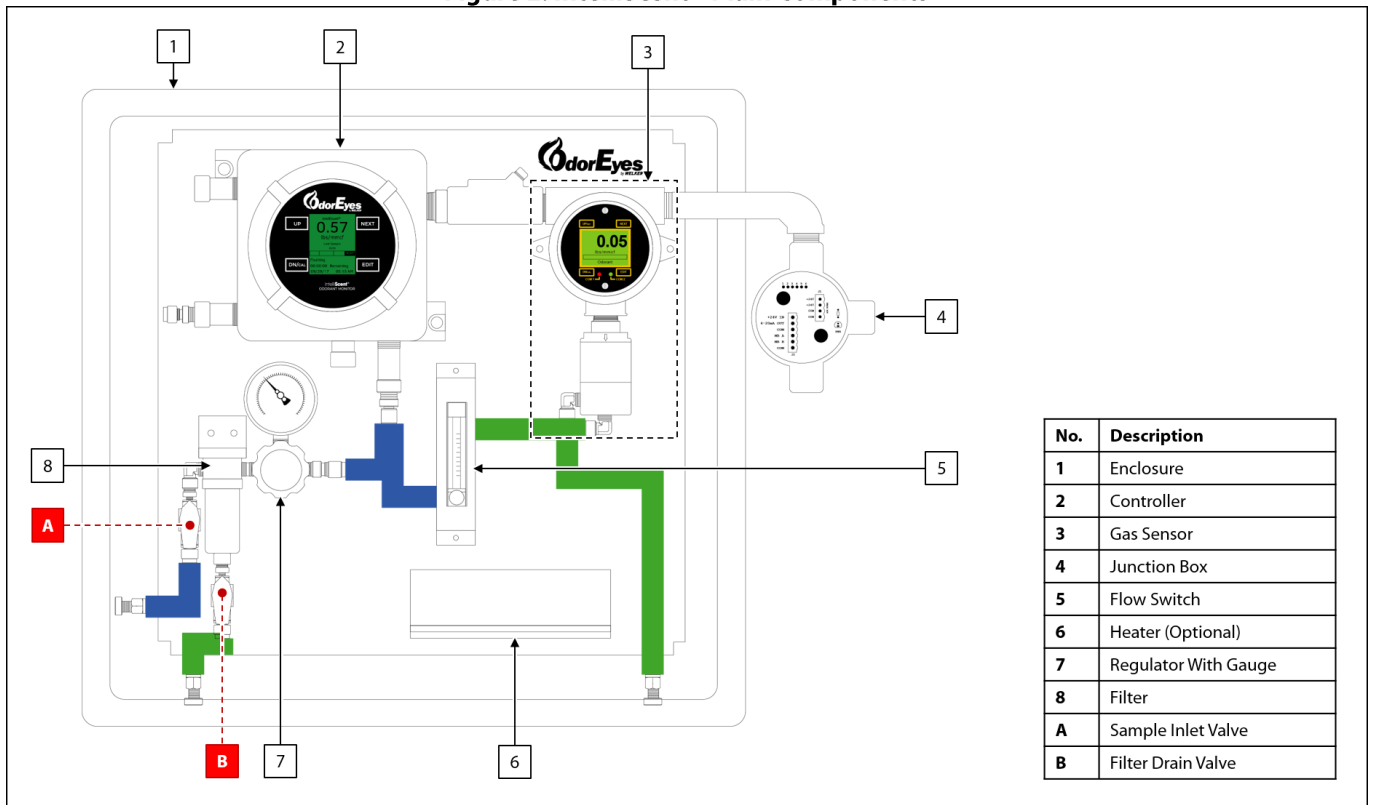
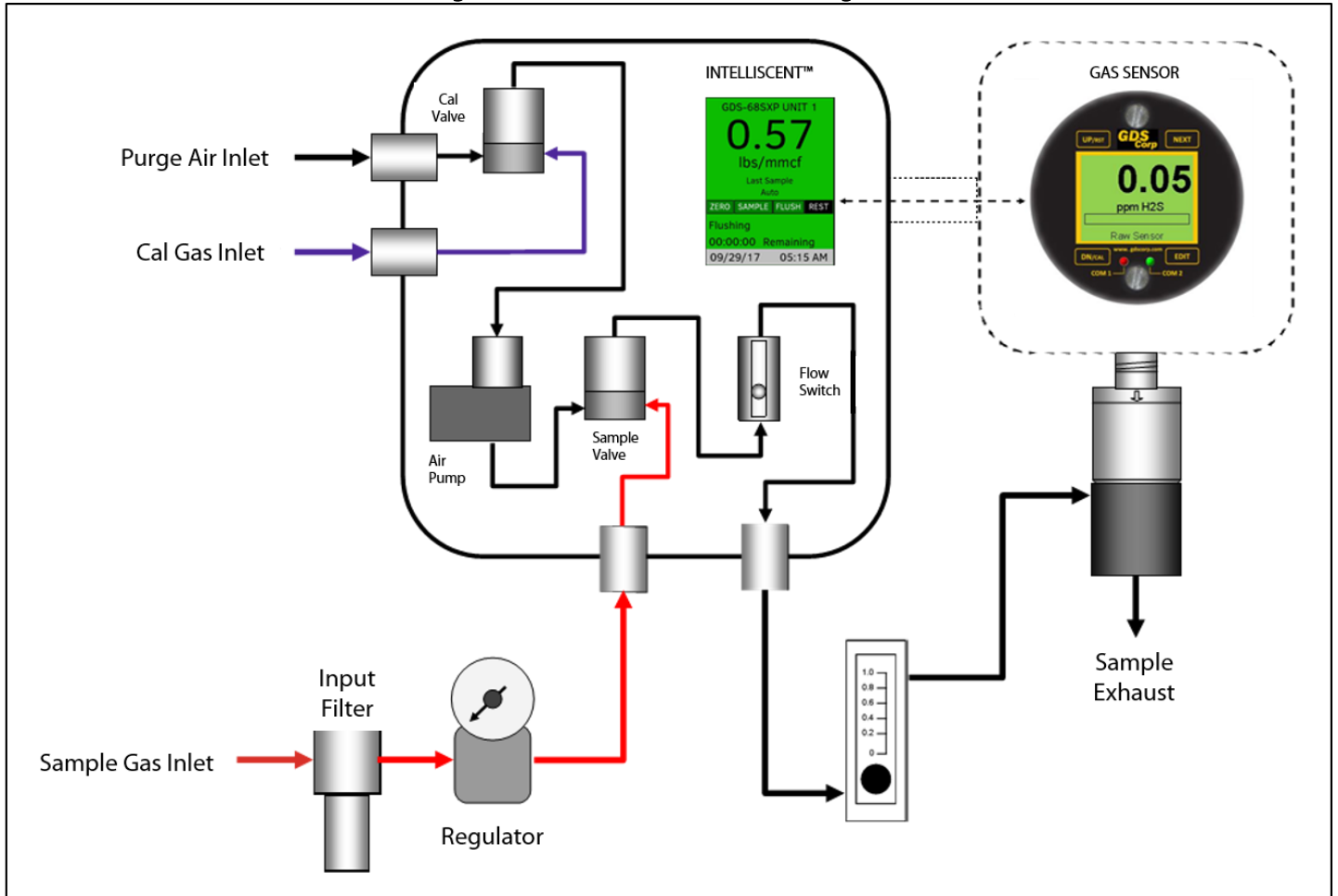

Figure 3: IntelliScent™ Functional Diagram



SECTION 2: INSTALLATION & OPERATION

2.1 Before You Begin



After unpacking the unit, check the equipment for compliance and any damage that may have occurred during shipment. Immediately contact a Welker representative if you received damaged equipment.



When sealing fittings with PTFE tape, refer to the proper sealing instructions for the brand used.



The IntelliScent™ will ship mounted in an enclosure and “hard-tube” connected with manufacturer-supplied fittings and hardware. However, the customer will need to supply some tubing and fittings in order to complete installation.



All electrical connections must meet local and national electric codes, and excessive weight added to the conduit run must be supported.

2.2 Principles of Operation



The IntelliScent™ periodically applies sample gas to an electrochemical sensor, records and displays the peak reading, purges the sensor with clean air, and repeats the process on intervals programmed by the operator. This technique maximizes accuracy, increases sensor life, and reduces the total amount of gas released to the atmosphere.

Normal Conditions

1. Under normal conditions while resting, ambient air is forced into the sensor via the cal valve and air pump.
2. At the beginning of each measurement cycle, a zero-reference measurement is made.
3. Once the zero reading is recorded, the sample valve is opened, allowing gas from the sample inlet to flow through the flow switch, flow meter, and into the local sensor element.
4. During this time, the controller monitors the gas detector output and flow switch to identify and store the peak value and verify sample flow through the system.
5. Once this peak value has been found, the sample valve is closed, and the air pump is turned back on to flush the sample gas and residual odorant from the sensor element.
6. After the reading falls below a preset threshold and all measurement cycle error checks are complete, the measured value is transferred to the controller display.

Calibration



When running a calibration, reference gas is connected via the cal gas inlet using a demand flow regulator. During a *gas sensor* calibration, gas is applied manually. During a *system calibration*, gas is automatically applied to the sensor element as needed during the calibration cycle.

System Calibration

Figure 4: Typical Measurement System Calibration Cycle

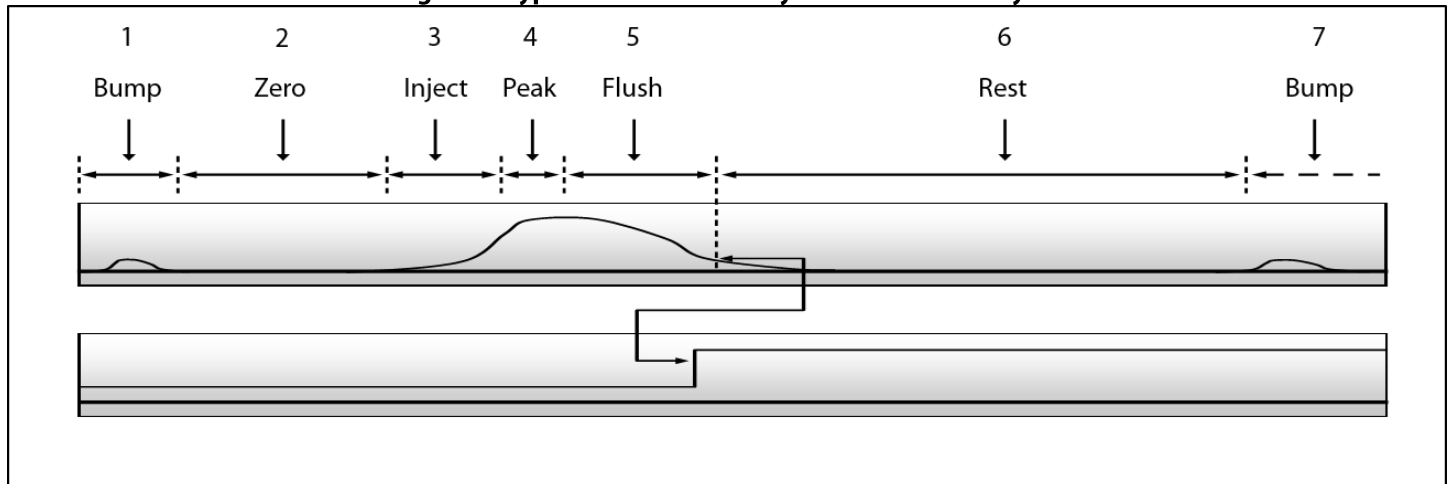

1. At the beginning of the cycle, a small amount of gas is injected into the sensor element ("Bump").
2. The sensor element is then allowed to rest for several minutes, during which the resting zero is measured ("Zero").
3. The sample valve is then turned on ("Inject") and the gas sensor output begins to increase.
4. After a fixed minimum time, a peak-find algorithm in the IntelliScent™ is used to determine the peak reading value ("Peak").
5. Once the peak value is stored, the sample valve is closed, and the air pump is turned on to flush the methane gas and odorant from the sensor element ("Flush").
6. Once the gas sensor output drops below 10% of scale and no cycle errors are detected, the calculated value is transferred to the display, analog output, wireless database, and MODBUS register database.
7. The unit then rests ("Rest") until the beginning of the next sample ("Bump").

2.3 Installation

1. Mount the IntelliScent™ vertically to a pole or wall as close to the pipeline as possible. Allow at least 6" of clearance on the top and right side of the unit and at least 18" of clearance on the left side and below the unit for conduit connections, sample connections, and drain connections.



Always mount the IntelliScent™ vertically to ensure proper operation of the flow switch and filter drains.



If mounted outdoors, ensure that all drains and vents have in-line filters or screens to keep dust and insects out of the tubing and sensor head.



Welker recommends mounting the IntelliScent™ so that the LCD screens are shielded from direct sunlight, as extended exposure to direct sunlight will damage the display components.

Figure 5: Dimensions With Wall-Mounting Kit

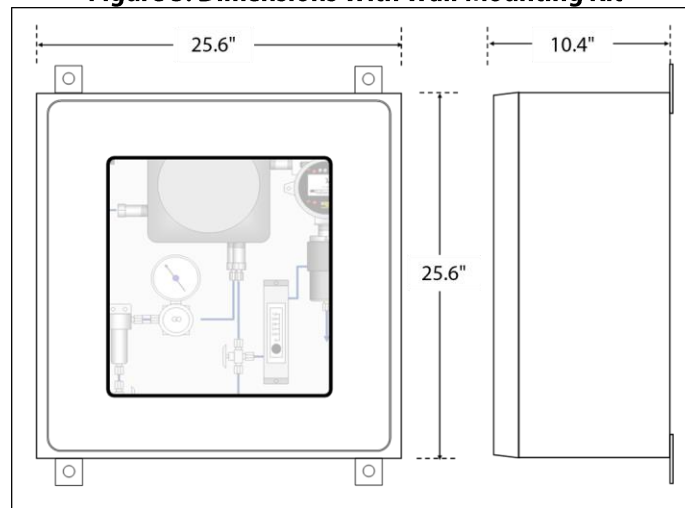
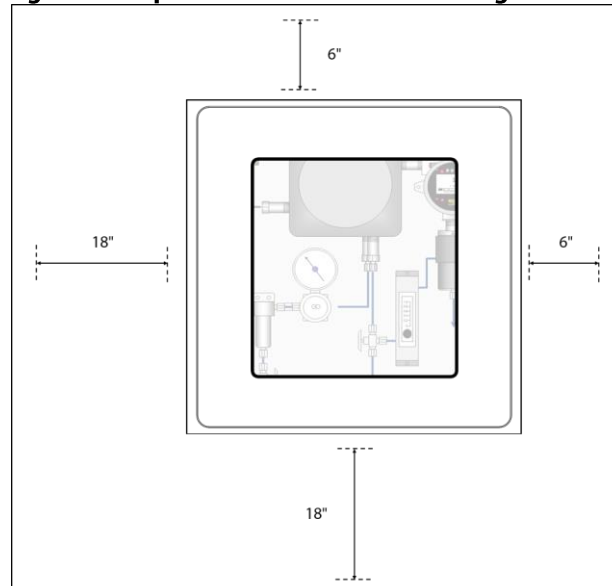

Figure 6: Required Clearance for Mounting Enclosure



Sample Inlet



When fabricating external tubing connections for sample inlet and filler drain outlets, never use straight connections as they can be difficult to remove once installed. Always include one or more 90° bends to make removal and replacement easier.



Welker recommends installing a low-volume high-pressure regulator / filter at the point where the gas is extracted from the pipeline. This will minimize the pressure in the line between the gas extraction point and IntelliScint™, further reducing the total volume of gas stored in the sample line.



If the IntelliScint™ will be installed in excessively cold climates, Welker recommends heat-trace on incoming sample tubing and an enclosure heater to ensure that any moisture in the sample remains gaseous and does not freeze as it flows through the inlet tubing and internal components.

Figure 7: Recommended General Arrangement

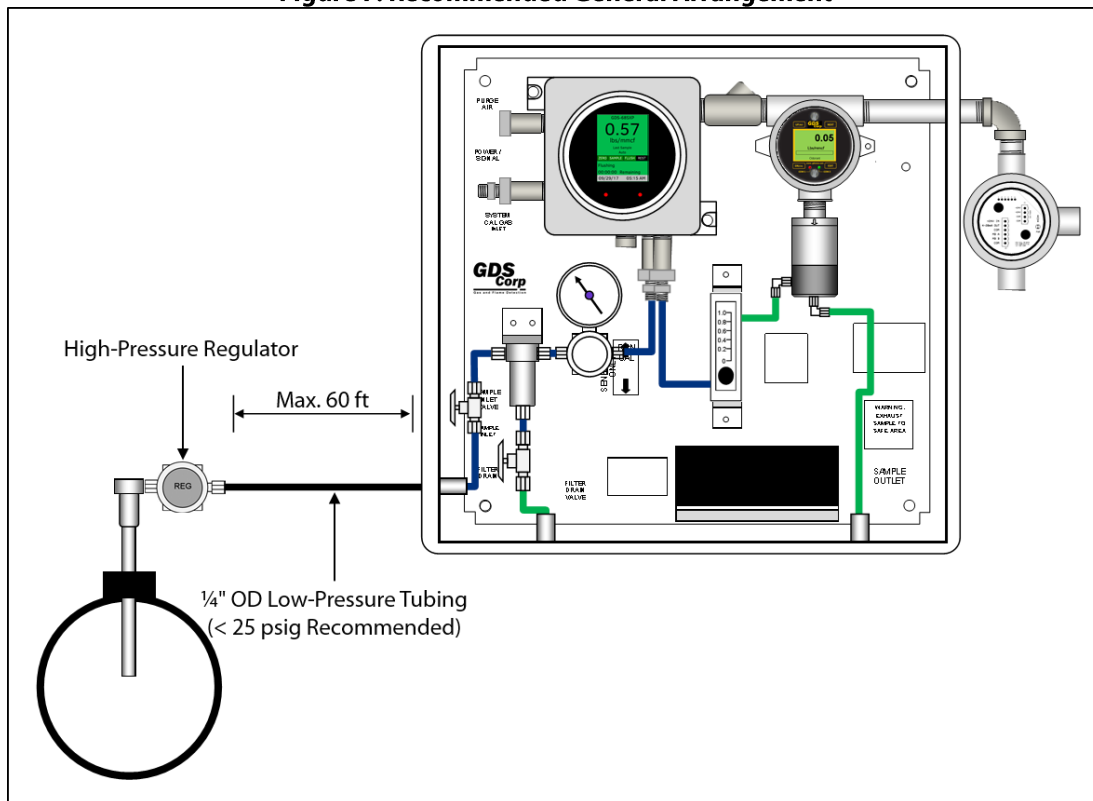

2. Connect from the pipeline to the sample inlet (*Figure 1*).



Connect the inlet tubing to a line that contains fresh gas. In cases where the IntelliScint™ has been connected to stub headers, the values read by the IntelliScint™ may be up to 6–8 hours behind the actual value measured in the pipeline.



The length of time it takes for gas to flow from the sample source to the IntelliScint™ should not exceed 30 seconds to ensure that fresh sample is available at the beginning of each measurement cycle.

For 1/4" OD stainless steel tubing and sample flow rates of approximately 0.5 liters per minute, the maximum length should be no more than 60 ft (18 m). Smaller diameter tubing will allow longer runs but may be subject to clogging if the sample contains particulates or moisture. Larger diameter tubing should be avoided due to the internal volume of entrained gas.

Cal Gas Inlet



Do not apply pressurized calibration gas to the cal gas input. Use a demand flow regulator or gas sampling bag.

- Using flexible tubing, connect a cylinder of calibration gas to the calibration gas inlet (*Figure 1*).
- Open the calibration gas valve and confirm that gas is not flowing.

Purge Air Inlet

Figure 8: Purge Air Inlet

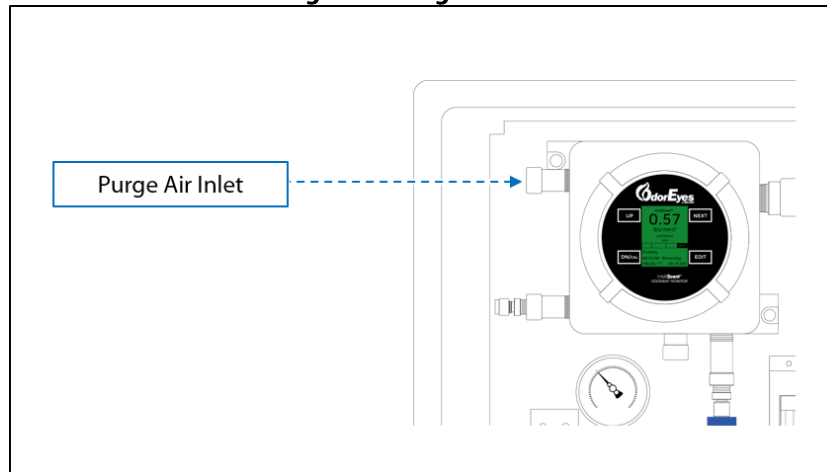

- Connect from an ambient air source to the purge air inlet.



Purge air should be drawn from a source of ambient air that is clean and free of significant levels of mercaptan or other toxic gases.



In most cases, it is desirable to draw purge air from inside the enclosure, as this generally ensures that the air is clean and warm and that liquid moisture or ice cannot collect on the inlet. This also provides an early warning of any gas leakage into the enclosure by elevating the sensor zero, resulting in a Zero Offset warning condition.



If the local area may contain residual gas, Welker recommends placing an external purge air inlet in a location that is free from background gas and protected from heavy rains, water spray, and snow or ice. Cover all openings with screens to prevent insects from entering.



The IntelliScent™ includes a purge air inlet filter with replaceable element.

Filter Drain



When fabricating external tubing connections for sample inlet and filter drain outlets, never use straight connections as they can be difficult to remove once installed. Always include one or more 90° bends to make removal and replacement easier.



Use clear flexible tubing where possible on filter drain lines as this makes it easier to determine if moisture is present in the sample drain line.

6. If desired, tube from filter drain valve B to an appropriate draining location (*Figure 2*).
7. During operation, periodically open filter drain valve B to drain any built up liquid (*Figure 2*). Filter drain valve B can be left slightly open to allow moisture and sample gas to escape.



Leaving the filter drain valve slightly open will allow sample gas to flow from the pickup point to the IntelliScent™ on a continuous basis, ensuring that fresh sample is always available at the beginning of each new measurement cycle.

Figure 9: Recommended Exhaust Configuration

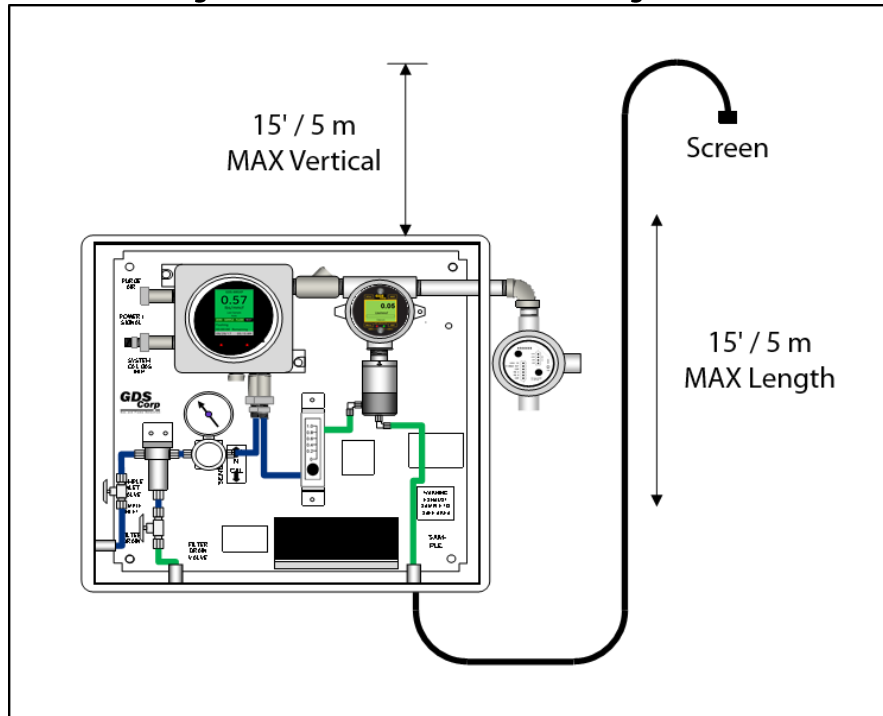

8. Tube from the sample exhaust to an area away from personnel and equipment (*Figure 2 and Figure 9*).



Ensure exhaust gas is directed away from personnel and equipment, especially sumps or low-lying areas where gases can build up over time.



Welker recommends the Welker Atmospheric Exhaust Filter for use with this unit.



DO NOT restrict the sample exhaust outlet. Pressure in the sample flow cell may damage the sensor and will result in incorrect readings.



Welker recommends the sample exhaust be as short as possible. Changes in ambient pressure affect the output from all electrochemical sensor elements; allowing the sample to exhaust directly to the atmosphere will minimize these effects.



Long tubing runs connected to the sample exhaust may increase the backpressure inside the sensor flow cell and cause higher than normal readings. Typical odorant is a heavy gas and tends to "back up" inside sample exhaust lines that extend vertically for too great a distance.



When installing the IntelliScent™ outdoors, ensure the sample exhaust is protected by a screen or filter to keep insects from entering the exhaust port and nesting in the sensor flow cell.

Electrical Connections



Always use recommended conduit and poured seals for signal and power wiring installation in hazardous areas. Consult local codes and regulations where appropriate.

Power and Signal Connections



Power, analog, and digital signal connections are located in the wiring junction box that extends out of the upper right-hand side of the IntelliScent™.

Figure 10: Wiring Junction Box

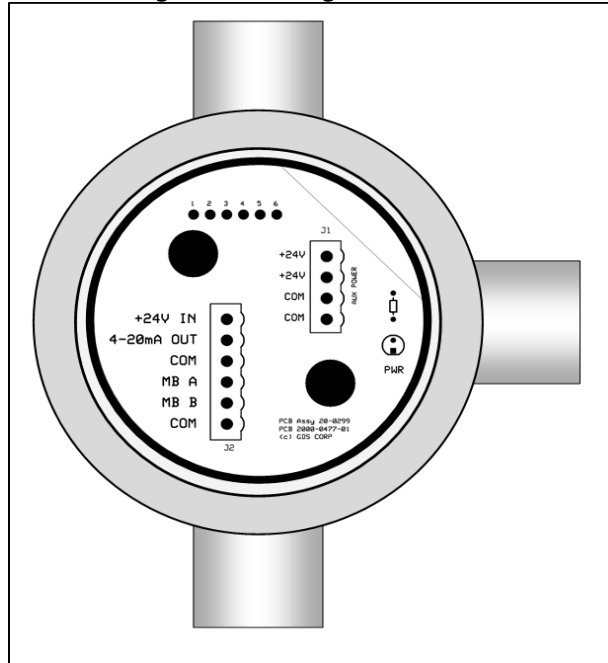

9. To access the power and MODBUS terminals, remove the cover of the junction box (*Figure 1* and *Figure 10*). An LED indicator will illuminate if DC power is applied to the unit.
10. Connect a source of DC 24 V, $\pm 5\%$ power to Pin 1 (+24V IN) and Pin 3 (COM) (*Figure 10*). The non-isolated 4–20 mA current loop source output is available at Pin 2 (4–20mA).



Possible values for the analog output current loop include the standard 4–20 mA range, as well as values between 4 mA and 0 mA that indicate fault conditions. Ensure that any device monitoring the 4–20 mA signal is capable of measuring and responding to discrete values less than 4 mA.

MODBUS Interface



The IntelliScent™ provides a two-wire serial RS-485 RTU interface (“A” and “B”) that allows a remote MODBUS serial master to request data from the controller’s MODBUS database.



A second parallel common is available for MODBUS wiring (Pin 6).



A complete description of the internal MODBUS database is shown in *Appendix A, MODBUS Registers*.

11. Connect a two-wire MODBUS master device to the IntelliScent™ using Pin 4 (“A”) and Pin 5 (“B”) (*Figure 10*).

AC Heater (Optional)



All high voltage AC wiring must be kept separate from lower voltage DC and signal lines.



Keep all electrical fittings tight while circuits are live.



Welker recommends the 200 W AC-powered heater for outdoor applications where ambient temperatures may fall below freezing for extended periods of time.



Local codes and good wiring practices require an AC shutoff within sight of the heater assembly for maintenance and testing.

12. If the IntelliScent™ is equipped with the optional heater, connect an AC 110 V power supply to the heater (*Figure 11*).



Access heater wiring via a $\frac{3}{4}$ " NPT fitting on the bottom of the heater junction box.

Figure 11: Optional Heater

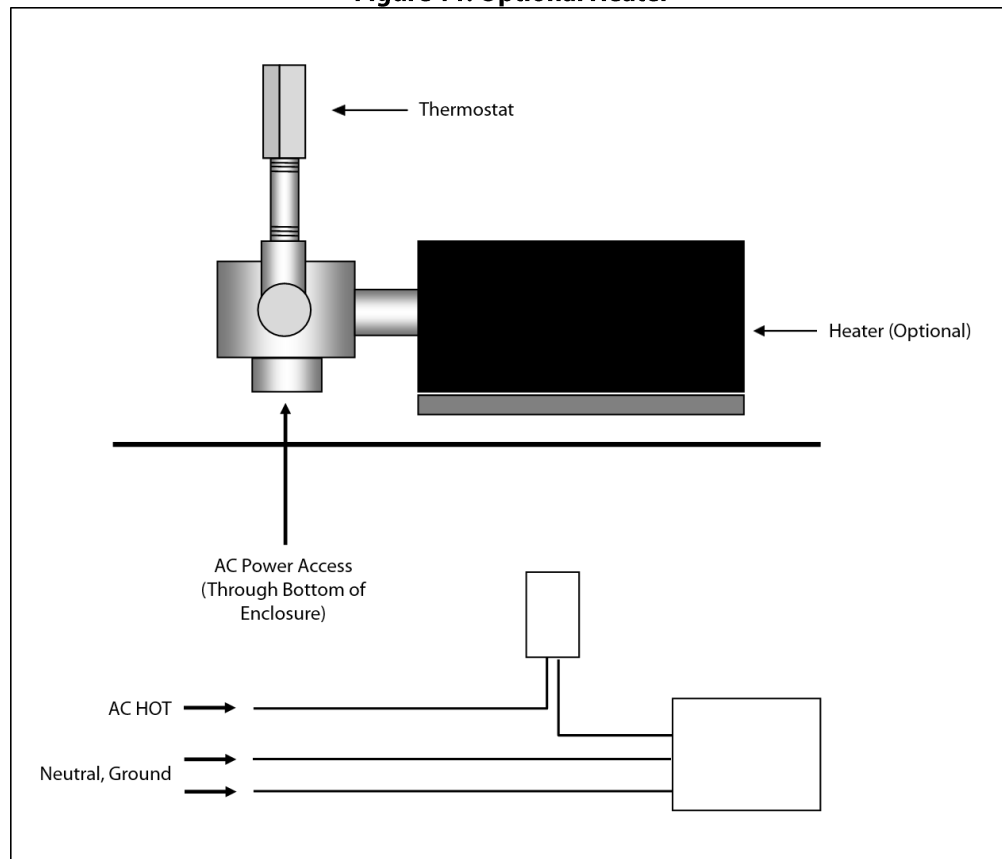

2.4 Start-Up Procedures

Table 2: Startup Procedures	
Step	Procedure
1	Mount the IntelliScent™ to a pole or wall using the hardware supplied, pole mount kit, or customer-supplied hardware. Face away from direct sunlight. Connect the analog signal and/or MODBUS interface wiring.
2	Remove the yellow plug covers and direct the filter outlet and sample outlet to a safe location. If using tubing to direct the flow, run independent sample exhaust and filter / filter bypass exhaust lines (DO NOT combine these two into a single line).
3	Close sample inlet valve A and filter drain valve B (<i>Figure 2</i>).
4	Connect a source of line gas to the sample inlet port (<i>Figure 1</i>). Keep the sample inlet pressure between 10 psig and 25 psig if possible.
5	Connect a cylinder of calibration gas with a demand flow regulator to the cal inlet port using flexible tubing (<i>Figure 1</i>). Open the calibration gas valve and confirm that gas is NOT flowing.
6	Apply power to the IntelliScent™ and watch for the display to illuminate and the IntelliScent™ screen to appear. Monitor the IntelliScent™ screen and watch for the Power OK message, Comm OK message, Sensor OK message, and Warm-Up message. NOTE: Warm-up will not commence until the sensor element output is within +/-10% of zero.
7	With the pump running, set the purge air flow to between 0.5 and 0.7 LPM by adjusting the valve on the flow meter. DO NOT adjust the flow meter after this step.
8	Enter the Diagnostics Menu. Set the air pump to "Off" and confirm that the flow switch status shows "No Flow."
9	Set the sample valve to "On" and verify that the flow switch status shows "Flow OK." Ensure that sample gas is flowing through the flow meter.
10	Adjust the inlet regulator such that the sample flow rate is between 0.5 and 0.7 LPM. Allow the flow to continue until the gas sensor shows a stable value, approximately three (3) minutes. Set the sample valve to "OFF" and the air pump to "ON" to purge the sensor element for three (3) minutes.
11	In the Diagnostics Menu, set the cal gas valve to "On" and verify that the flow switch shows "Flow OK." Ensure that cal gas is flowing. Set the cal valve to "Off" and exit the Diagnostics Menu.
12	Enter the System Menu and program the desired initial delay and sequence interval before warm-up is complete. Initial startup is now complete. See <i>Section 4, Calibration</i> , for calibration procedures.

3.1 Understanding the Primary Display



The primary user interface for the IntelliScent™ is in the left-hand gray explosion-proof enclosure.



The interface consists of a 320x240 full color LCD screen and four (4) magnetic switches surrounding the display. To activate the magnetic switches, open the explosion-proof cover and place a magnetic wand close to the switch or use the IntelliScent™ iOS app to activate functions wirelessly.

Figure 12: IntelliScent™ User Interface and Main Screen

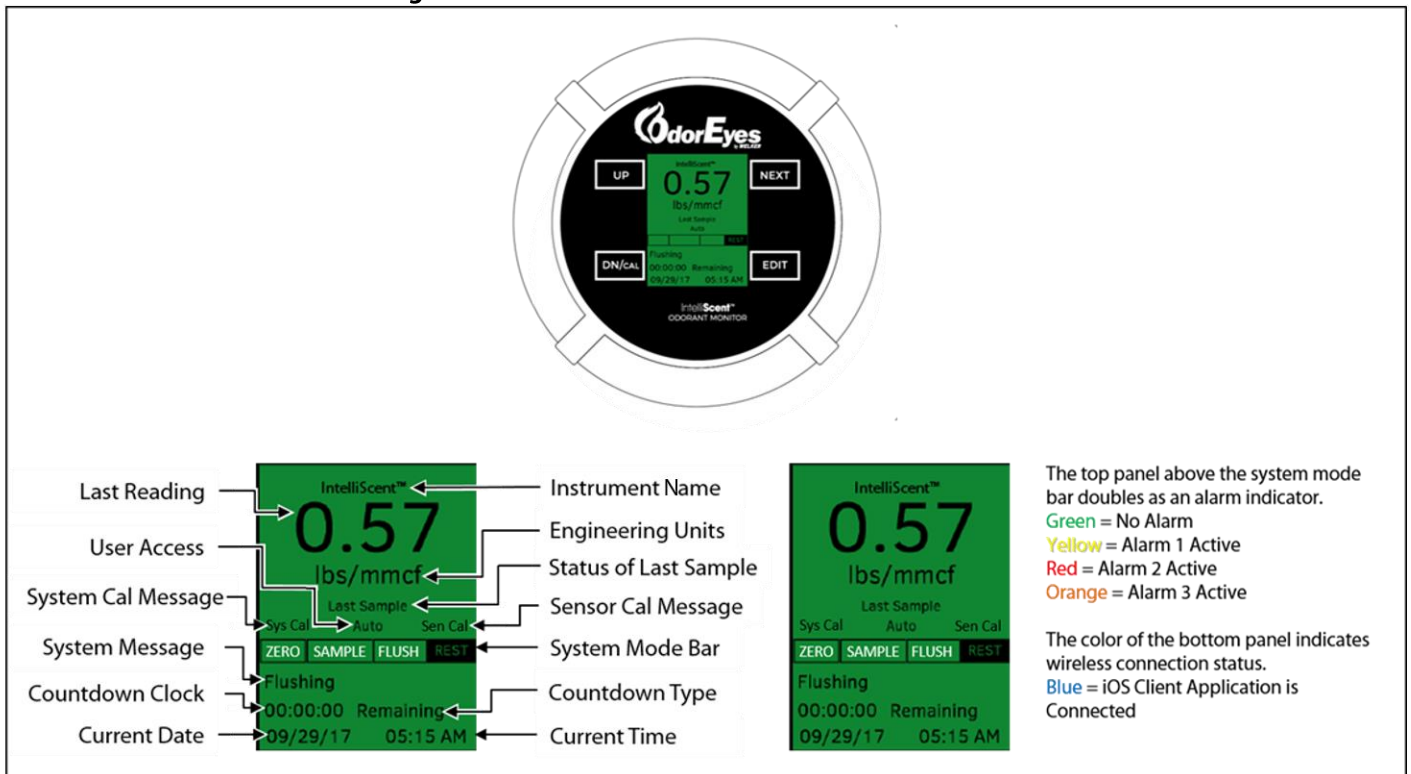

The user interface screen gives a snapshot of the unit's operational status and provides the real-time information described in Table 3.

Table 3: IntelliScent™ User Interface Display	
Label	Description
Instrument Name	A user-programmable 16-character text name assigned to this unit. The instrument name can be entered in the System Setup Menu.
Last Reading	The most recent calibrated odorant measurement reading. A negative number implies one or more errors occurred during the measurement cycle.
Engineering Units	The current sensor element's engineering units. This can be "lbs/mmcf" or "mg/m3." This information is retrieved from the gas sensor and cannot be changed.
Status of Last Sample	Shows the date and time of the last successful reading or an error warning if the last sample did not complete successfully.
User Access	If "Ready," the user can immediately initiate a measurement cycle or calibration cycle. If "Busy," these operations are temporarily disabled because of proximity to previous measurement cycles.
System and Sensor Cal Message	Indicates whether system calibration or sensor calibration is required. If CAL ONCE is selected, message will report "Cal Nxt" to indicate the next cycle is a calibration cycle.
System Mode Bar	Shows the status of the IntelliScent™ measurement cycle (i.e., "Zero," "Sample," "Flush," or "Rest").
System Message	Additional information regarding measurement status or errors.
Countdown Clock	Shows time until next event, either completion of a current measurement cycle or time remaining until the start of the next measurement cycle.
Countdown Type	If showing "Remaining," the countdown clock shows a fixed time to the next event. If showing "Until Timeout," countdown clock displays maximum time remaining to complete the current task (measuring zero, measuring gas, flushing sensor, etc.) before a timeout error is recorded.
Current Date	Internal clock date. This can be programmed in the Tech Settings Menu or via the IntelliScent™ iOS app.
Current Time	Internal clock time. This can be programmed in the Tech Settings Menu or via the IntelliScent™ iOS app.

Accessing Menu Items Manually

1. Press the Next key when the main screen is showing to bring up the reading screen that shows the time, date, and value for the last eight (8) readings (Figure 13).

Figure 13: Last Readings Screen

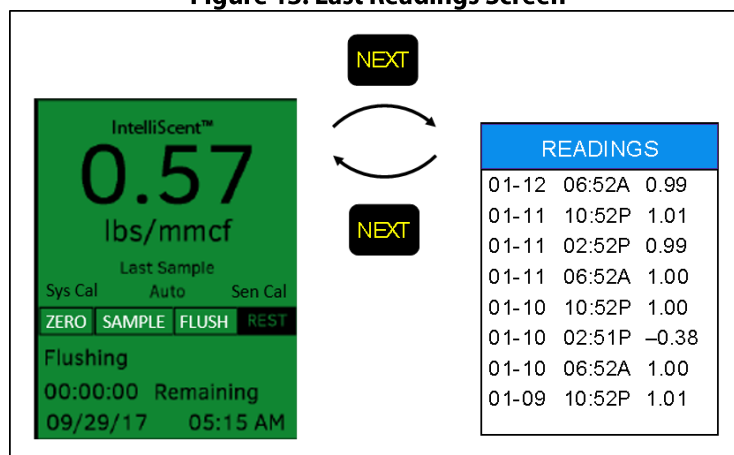

- Repeatedly press the UP key when the main screen is showing to cycle through the Quick Menu: Last Sample Screen, Last Cal Screen, System Status 1 Screen, and System Status 2 Screen (Figure 14).



Cycling through the Quick Menus allows a technician to view important system settings without having to enter the Main Menu and risk accidentally changing a setting.

Figure 14: Quick Menus

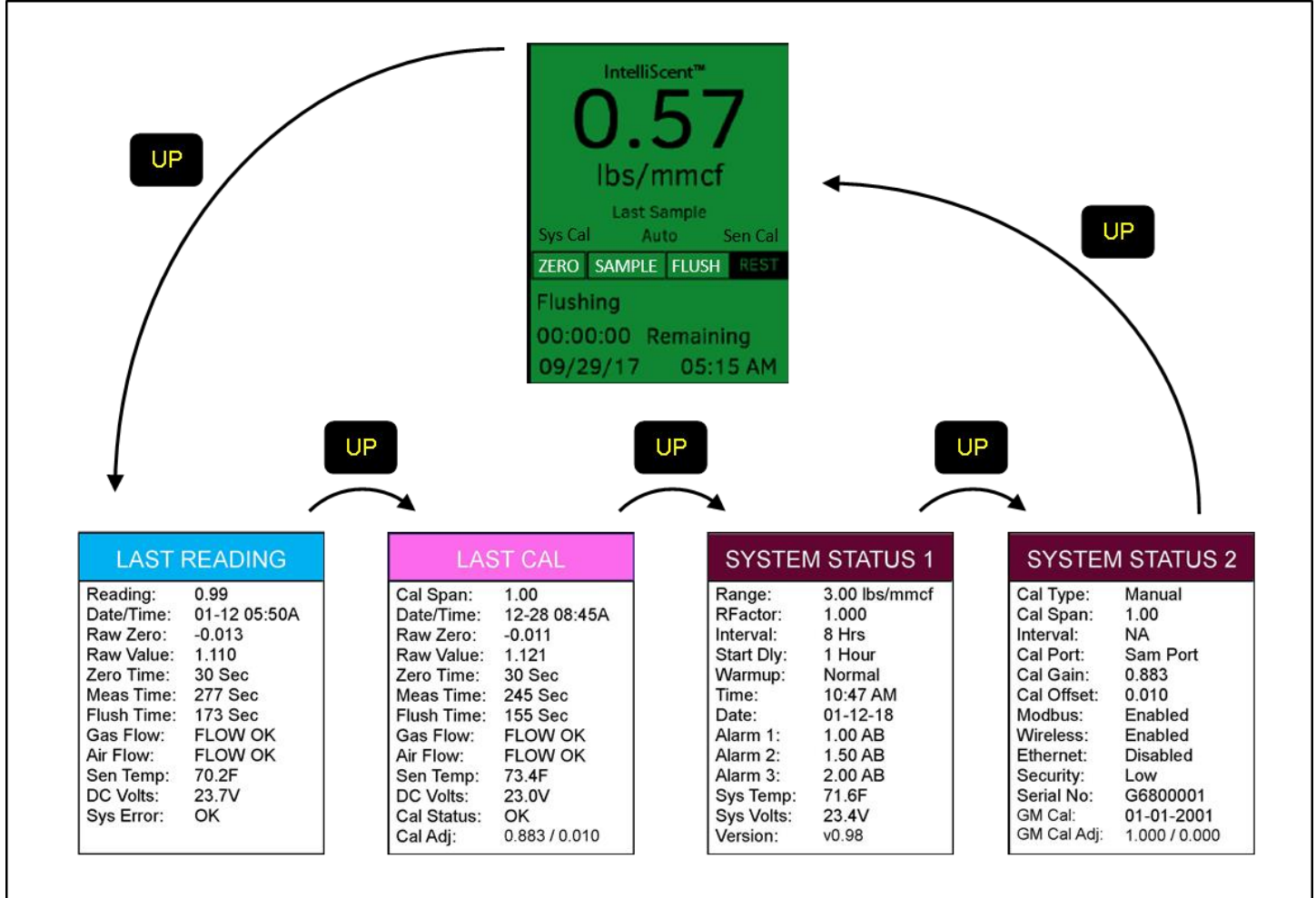

3. Press the Edit key when the main screen is showing to bring up the Main Menu (Figure 15).

Figure 15: Access the Main Menu

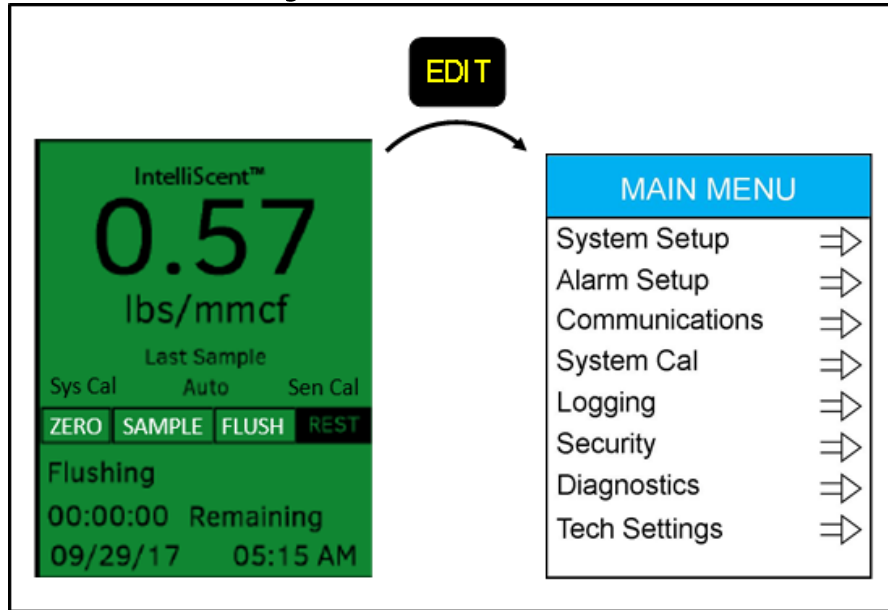

4. Once in the Main Menu, selecting an entry and pressing Edit will provide access to all system settings and parameters (Figure 16).

Figure 16: Main Menu Structure

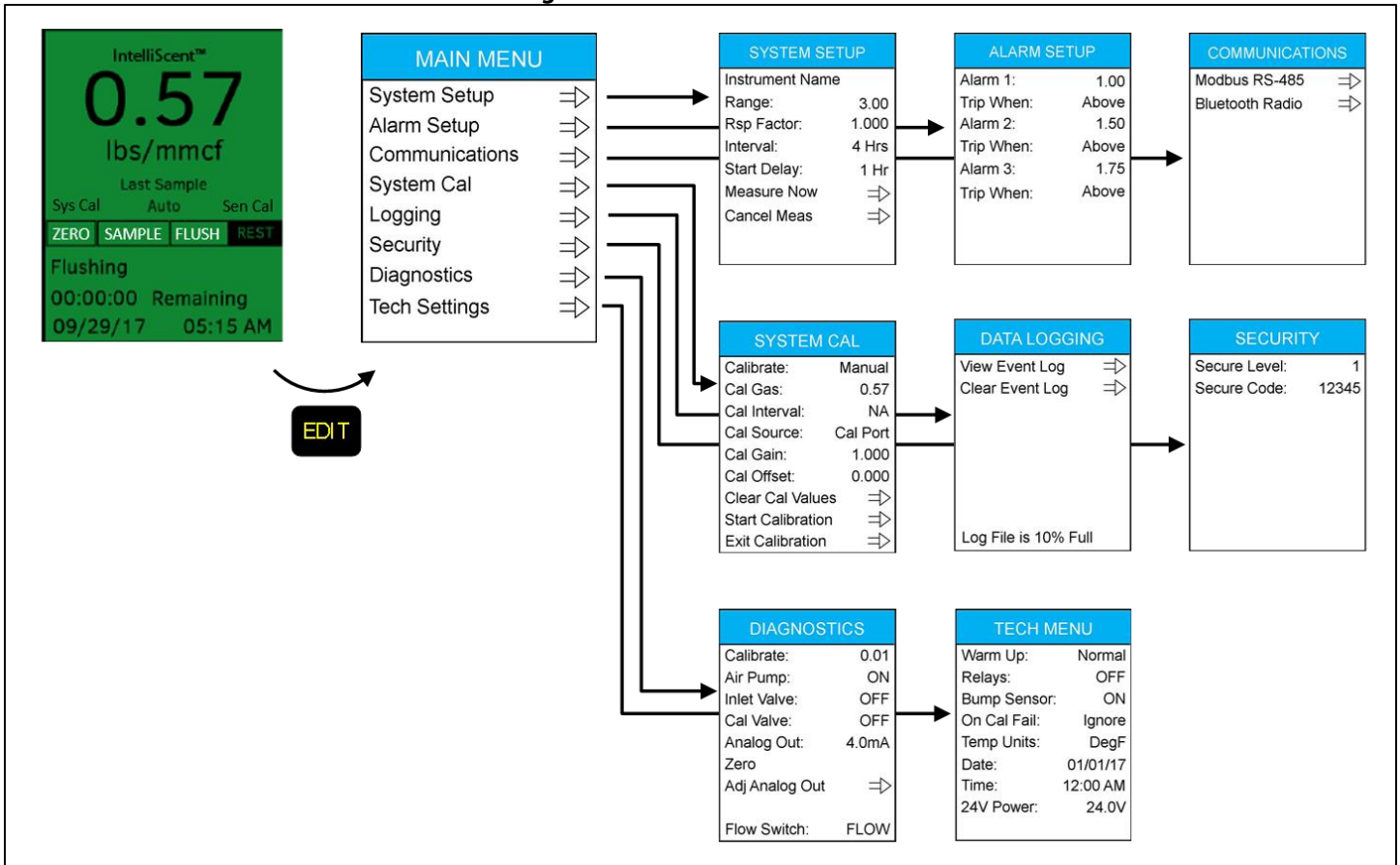

Main Menu items include all options necessary to program and operate the IntelliScent™. A complete description of all menu items and choices is shown in Section 5.1, *IntelliScent™ User Menus*.

3.2 Understanding the Gas Sensor Display



The gas sensor includes the sensor element and the electronics and processing necessary to generate calibrated, temperature-compensated gas concentration data used by the IntelliScent™.



There are four (4) magnetic switches on the face of the gas sensor labeled Up, Next, Edit, and DN/CAL (Figure 17). To activate or “press” a magnetic switch, swipe the magnetic wand near the switch.

Figure 17: Gas Sensor Display

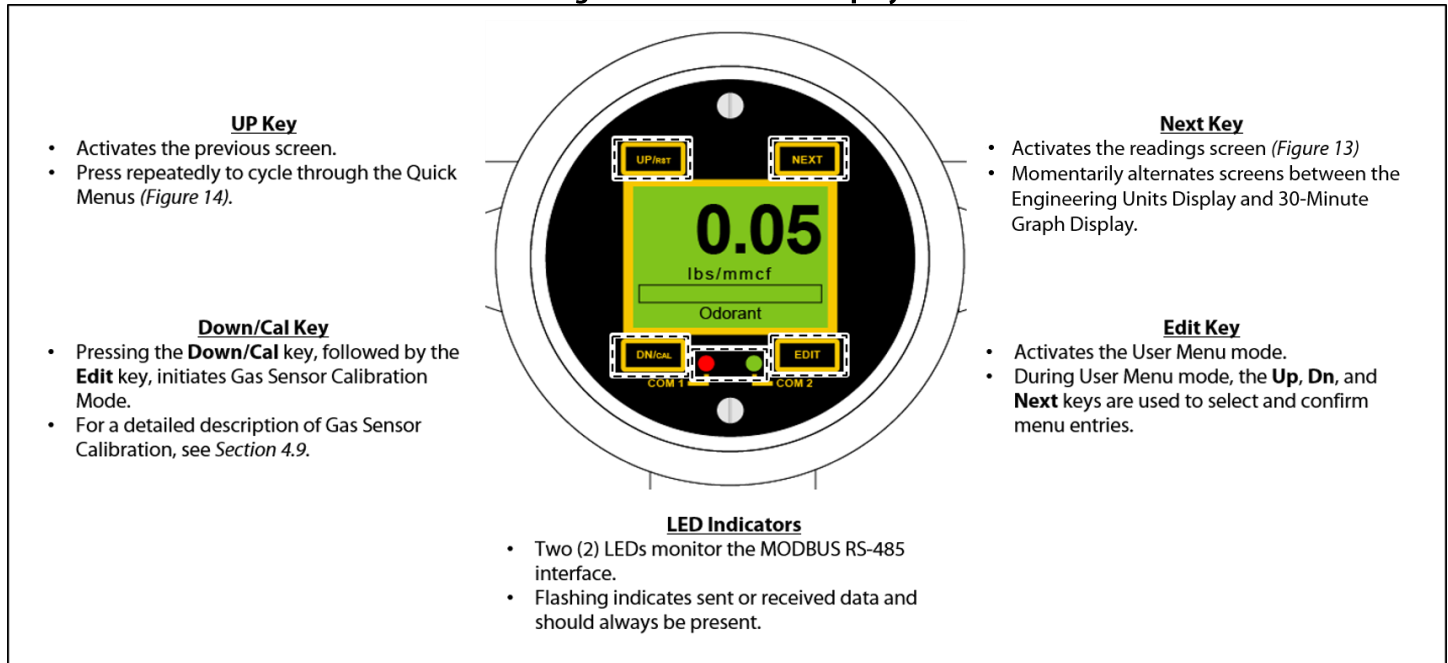

Most settings in the gas sensor are uploaded from the sensor element or are preset by Welker and should not be modified. Use caution when making changes, as incorrect settings may cause the IntelliScent™ to malfunction.

SECTION 4: CALIBRATION

4.1 Calibration Overview



Always run a gas sensor calibration and a system calibration AFTER installation or AFTER the sensor element is replaced.

Calibration is critically important to ensure correct and accurate operation of the IntelliScent™. There are two (2) steps necessary to calibrate the IntelliScent™: **System Calibration** and **Gas Sensor Calibration**.

Table 4: Calibration Types

Calibration Type	Description
System Calibration	An automated measurement cycle that uses reference span gas to calibrate the end-to-end system response. System calibration cycles can be performed manually or can be programmed to occur automatically on a daily, weekly, or monthly basis.
Gas Sensor Calibration	Uses the semi-automated calibration procedure in the gas sensor to ensure the sensor element's response to gas is within designated limits. Gas sensor calibration should be done periodically (every 90 to 180 days).

4.2 Span Gas

The best source of calibration span gas is a fresh cylinder containing a mixture of target gas / odorant and methane that replicates the expected gas sample. Welker has several varieties of accurate cylinders of gas/odorant mixtures available for purchase.

An alternative to custom mixtures is to use a cylinder containing pure tert-butyl mercaptan, isopropyl mercaptan, or tetrahydrothiophene in methane and apply an appropriate conversion factor.

If no gas cylinder is available and the gas stream contains a known amount of target gas / odorant, the IntelliScent™ can be calibrated "to the stream."

4.3 Zero Gas

Before each measurement cycle, the IntelliScent™ samples the background ambient air to determine the resting value for the sensor element. This process assumes that ambient air contains very low levels of odorant.

During gas sensor calibration, a cylinder of zero air (O₂/N₂) should be used in place of ambient air for maximum accuracy.



Never use pure methane for a zero reference, as oxygen is needed to refresh the sensor.

4.4 Connecting Calibration Gas to the IntelliScent™



Do not use a standard fixed flow regulator with a calibration gas cylinder, as this can damage the IntelliScent™ and void the warranty.

Connect the calibration gas cylinder to the cal gas inlet on the lower left side of the explosion-proof enclosure (*Figure 18*). The demand flow regulator will have a length of tubing that slips over the end of the calibration barb fitting on the cal gas inlet.

Figure 18: Calibration Cylinder – Temporary External Mounting

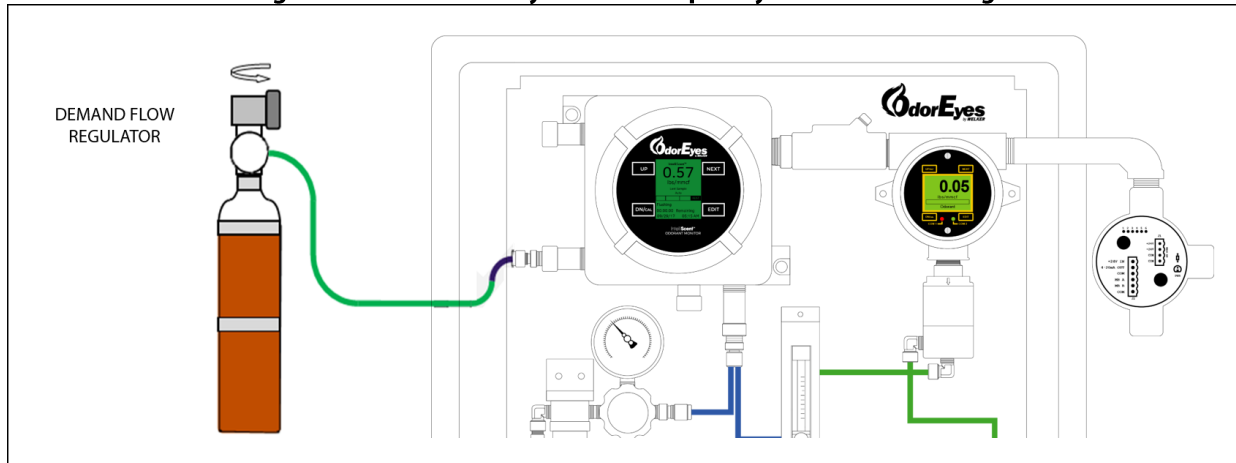

For permanent installation, Welker recommends the Calibration Cylinder Mounting Kit which contains a bracket that can hold 34- or 58-liter cylinders, a 3' length of flex tubing, and all necessary hardware. The kit can be installed internally (*Figure 19*) or externally if needed. Contact Welker for more information.



If using customer-supplied tubing for permanent installation, ensure that the tubing does not absorb odorant. Welker recommends flexible polymer tubing, such as Tygon® tubing, for calibration.

Figure 19: Calibration Cylinder – Optional Permanent Internal Mounting

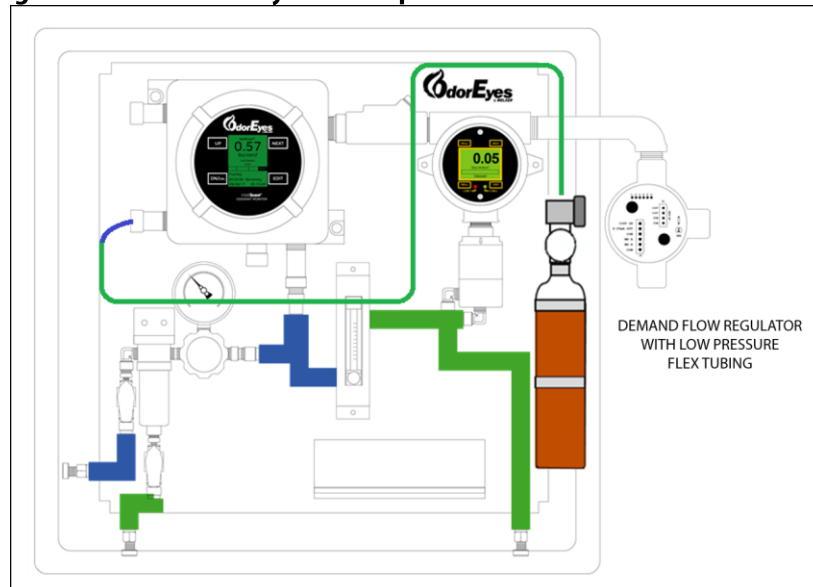

4.5 Cal Span Value

The cal span value should be set to the equivalent value of the calibration gas in the current engineering units setting. For example, 2.5 ppm tert-butyl mercaptan is equivalent to 0.57 lb/MMcf.

Contact Welker for more information on sensor element types and cal span value calculations.

4.6 System Calibration Overview



System calibration runs a complete measurement cycle, compares the results to preset target values, and generates a system level correction factor.



System calibration types can be Manual, Once, or Auto, and the source of the calibration gas can be Cal Port or Gas Stream. These settings can be found on the Main Menu » System Cal Menu screen.

Manual Calibration

Figure 20: Manual System Calibration

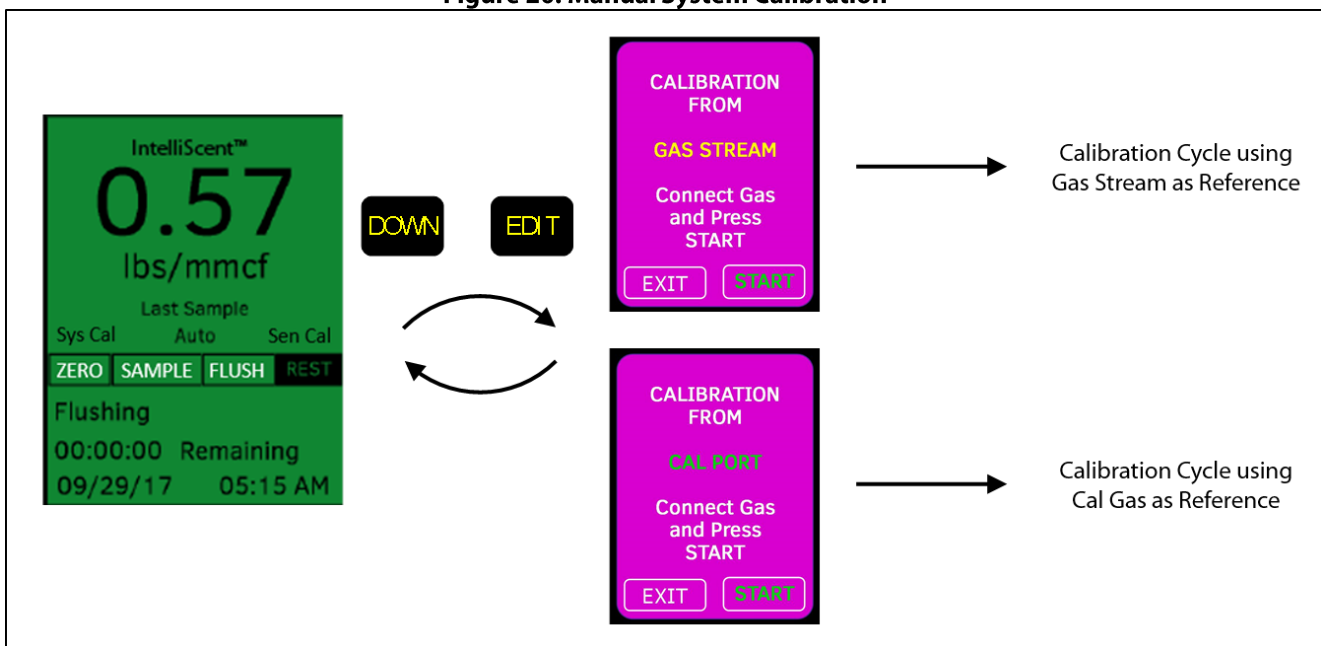

When the calibration type is set to Manual, a calibration cycle will only run when initiated by the user during rest more.



Initiate a system calibration cycle using a magnetic wand, via the IntelliScent™ iOS app, or via MODBUS. To manually start a system calibration cycle from the main screen, press the Down key, followed by the Edit key.



Before starting a manual calibration, select the Cal Port or Gas Stream input source in the System Cal Menu.



Once started, a system calibration cycle will proceed without any additional input from the user. If the cal cycle is successful, a Cal Success screen will appear; otherwise, a Cal Fail screen will appear.



If the IntelliScent™ has just completed a measurement cycle, the system status will show Busy, and manual calibration will be temporarily disallowed to allow the sensor time to recover from the exposure to target gas.

Automatic Calibration

The IntelliScent™ can be programmed for two (2) types of automatic calibration cycles: Once and Automatic Calibration. The cycles are identical; however, the initiation process is different.

Table 5: Automatic Calibration Types

Calibration Type	Description
Once Calibration	When the calibration type is set to Once, a calibration cycle will occur <i>in place of</i> the next measurement cycle. When choosing Once, select the desired calibration gas source. Once calibration can accept gas input from either the cal port or gas stream. Calibration type reverts to Manual when complete.
Automatic Calibration	When the calibration type is set to Auto, the IntelliScent™ will run calibration cycles in place of measurement cycles on time intervals programmed in the System Cal Menu. Automatic calibration intervals can be programmed for daily, weekly, or monthly intervals. When the IntelliScent™ determines an automatic calibration cycle is required, it will substitute a calibration cycle in place of the next measurement cycle. As a result, the output value shown on the display and indicated on the analog and MODBUS outputs will not change until the measurement cycle following the automatic calibration cycle is completed. Automatic calibration requires a source of calibration gas be connected to the cal port.

Failure Options



Since an automatic calibration cycle may occur when no one is present and may fail due to a bad sensor, lack of gas, or other reason, the IntelliScent™ offers three (3) ways to have the outcome of the calibration cycle affect the continued operation of the unit: "Ignore", "Fail", and "Notify". This setting is found in the Technicians Menu on the IntelliScent™.

Table 6: Automatic Calibration Failure Options

Failure Option	Description
Ignore	The result of the failed calibration is ignored, and calibration values from the last good calibration remain in effect.
Fail	The output goes into Cal Fault mode on the 4–20 mA output and MODBUS output.
Notify	During the beginning of each measurement cycle, the 4–20 mA output drops to 0 mA (-25% of scale) for 15 seconds before returning to its previous value. This setting is useful if the only output being monitored is the 4–20 mA analog value.

4.7 System Calibration Procedure – Cal Gas

To perform a system calibration using a cylinder of calibration gas, follow the steps in *Table 7*.

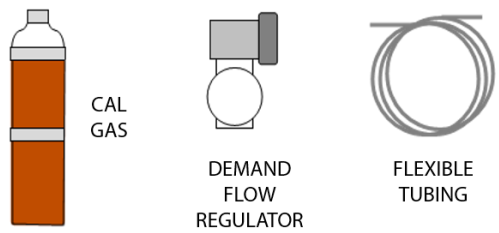
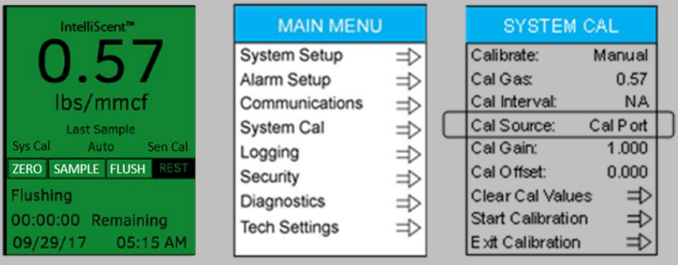
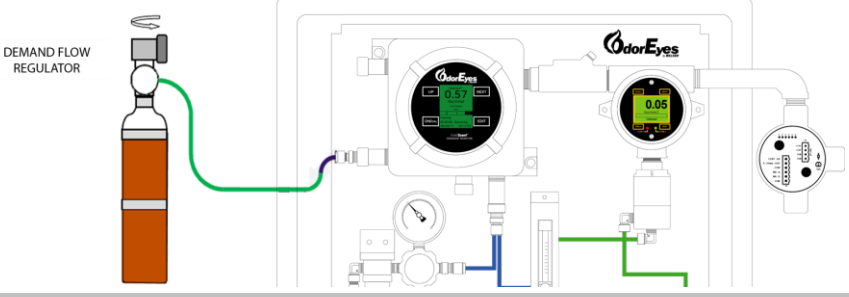
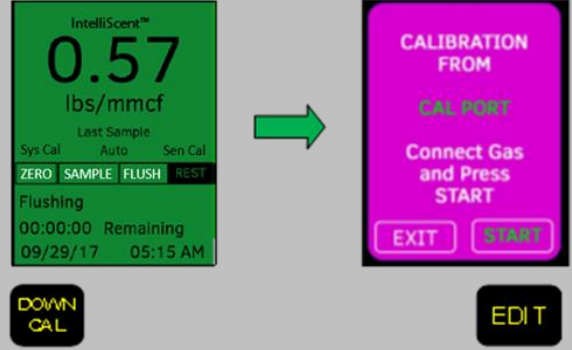
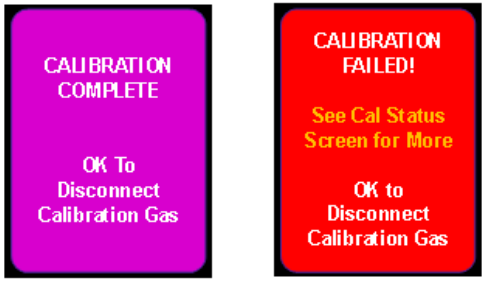
Table 7: System Calibration Procedure – Cal Gas		
Step	Procedure	Illustration
1	Obtain a cylinder of calibration gas (odorant + methane balance), a matching demand flow regulator, and a length of flexible tubing. Check the use-by date on the cal gas cylinder to ensure it has not expired.	 <p>CAL GAS</p> <p>DEMAND FLOW REGULATOR</p> <p>FLEXIBLE TUBING</p>
2	Enter the System Cal Menu and verify that the Cal Source is set to Cal Port. (From the main screen, press Edit to access the Main Menu. On the Main Menu, select System Cal and press Edit to view the System Cal menu.)	 <p>IntelliScent™ 0.57 lbs/mmcf Last Sample Sys Cal Auto Sen Cal ZERO SAMPLE FLUSH REST Flushing 00:00:00 Remaining 09/29/17 05:15 AM</p> <p>MAIN MENU System Setup → Alarm Setup → Communications → System Cal → Logging → Security → Diagnostics → Tech Settings →</p> <p>SYSTEM CAL Calibrate: Manual Cal Gas: 0.57 Cal Interval: NA Cal Source: Cal Port Cal Gain: 1.000 Cal Offset: 0.000 Clear Cal Values → Start Calibration → Exit Calibration →</p>
3	Attach the cylinder of cal gas to the cal inlet port using a demand flow regulator. Open the regulator valve by turning the top knob 90° in either direction.	 <p>DEMAND FLOW REGULATOR</p>
4	If User Access shows Ready, use the magnetic wand to press the DN/CAL button to initiate a system calibration cycle. Calibration can also be initiated using the IntelliScent™ iOS app or by sending a command via MODBUS.	 <p>IntelliScent™ 0.57 lbs/mmcf Last Sample Sys Cal Auto Sen Cal ZERO SAMPLE FLUSH REST Flushing 00:00:00 Remaining 09/29/17 05:15 AM</p> <p>DOWN CAL</p> <p>CALIBRATION FROM CAL PORT Connect Gas and Press START EXIT START</p> <p>EDIT</p>
5	The remainder of the System Calibration cycle will run automatically and show a Cal Complete or Cal Fail message. Once the cycle is complete, the unit will enter a cal delay and the User Access message will show Busy.	 <p>CALIBRATION COMPLETE OK To Disconnect Calibration Gas</p> <p>CALIBRATION FAILED! See Cal Status Screen for More OK to Disconnect Calibration Gas</p>

4.8 System Calibration Procedure – Stream

To perform a system calibration using the sample stream, follow the steps in *Table 8*.

Table 8: System Calibration Procedure – Stream		
Step	Procedure	Illustration
1	<p>Enter the System Cal Menu and verify that the cal source is set to Stream.</p> <p>Note: Calibration to the stream can only be done in Manual or Once mode. Automatic or repeating calibration must use a cylinder of calibration gas.</p>	<p>The screenshot shows the 'SYSTEM CAL' menu with the following settings: Calibrate: Manual, Cal Gas: 0.57, Cal Interval: NA, Cal Source: Stream (highlighted with a red box), Cal Gain: 1.000, Cal Offset: 0.000. At the bottom, there are three options: 'Clear Cal Values' with a right arrow, 'Start Calibration' with a right arrow, and 'Exit Calibration' with a right arrow.</p>
2	<p>Calculate, measure, or estimate the concentration level of odorant in the stream, and calculate the expected value. Enter that value as the cal span value in the System Cal Menu.</p>	<p>The screenshot shows the 'SYSTEM CAL' menu with the following settings: Calibrate: Manual, Cal Gas: 0.57 (highlighted with a red box), Cal Interval: NA, Cal Source: Stream, Cal Gain: 1.000, Cal Offset: 0.000. At the bottom, there are three options: 'Clear Cal Values' with a right arrow, 'Start Calibration' with a right arrow, and 'Exit Calibration' with a right arrow.</p>
3	<p>If User Access shows Ready, use the magnetic wand to press the DN/CAL button and then the Edit button to initiate a system calibration cycle. Calibration can also be initiated using the IntelliScent™ iOS app or by sending a command via MODBUS.</p>	<p>The diagram shows two screens connected by a green arrow. The left screen is the IntelliScent™ display showing a reading of 0.57 lbs/mmcf. Below the display are two buttons: 'DOWN CAL' and 'EDIT'. The right screen is a purple calibration screen with the text 'CALIBRATION FROM GAS STREAM' and 'Connect Gas and Press START'. It has 'EXIT' and 'START' buttons at the bottom.</p>
4	<p>The remainder of the system calibration cycle will run automatically and show a Cal Complete or Cal Fail message. Once the calibration cycle is complete, the unit will enter a 15-minute cal delay, and the User Access message will show Busy.</p>	<p>Two screenshots are shown side-by-side. The left one is a purple screen with the text 'CALIBRATION COMPLETE' and 'OK To Disconnect Calibration Gas'. The right one is a red screen with the text 'CALIBRATION FAILED!', 'See Cal Status Screen for More', and 'OK to Disconnect Calibration Gas'.</p>

4.9 Gas Sensor Calibration



DO NOT perform a gas sensor calibration unless the IntelliScent™ is in Rest Mode.

To perform a gas sensor calibration, follow the steps in *Table 9*.

Table 9: Gas Sensor Calibration Procedure

Step	Procedure	Illustration
1	Obtain a cylinder of zero air, a cylinder of calibration gas (odorant + methane balance), a matching demand flow regulator, and a length of flexible tubing.	
2	Determine the appropriate setting for the gas sensor cal span value as described in <i>Section 4.5, Cal Span Value</i> , and load the value in the gas sensor » XXXX Menu. (Main Menu » Channel Settings » Channel 1 » Calibrate Menu).	
3	Connect the zero air to the regulator, and then connect the regulator to the cal gas inlet port. Open the regulator valve by turning the top knob 90° in either direction.	
4	On the IntelliScent™ display, go to the System Menu » Diagnostics Menu, and set the cal valve to On. The flow switch should indicate Flow, and flow should be visible on the flow meter.	
5	Place the gas sensor into Cal Mode by using the magnetic wand to press the DN/CAL button and then the Edit button on the gas sensor display. The gas sensor display will show the “Apply Zero” message.	

Table 9: Gas Sensor Calibration Procedure (Continued)

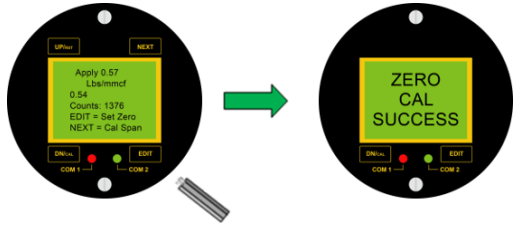
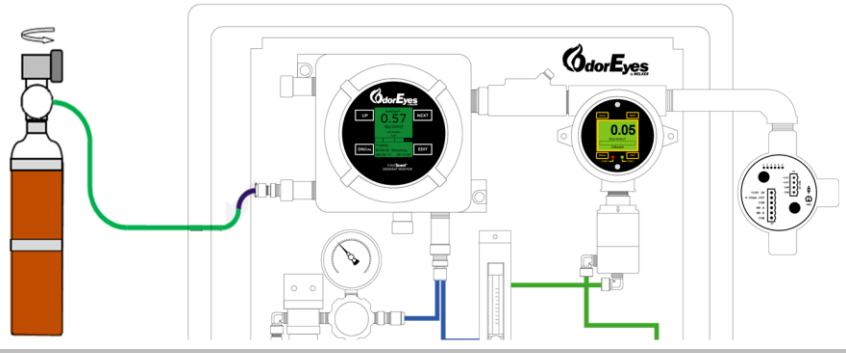
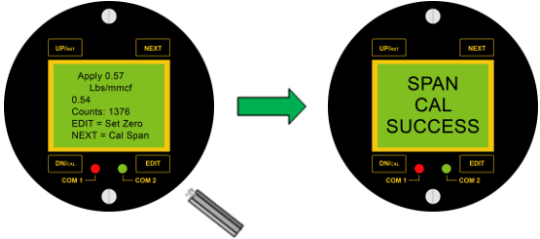
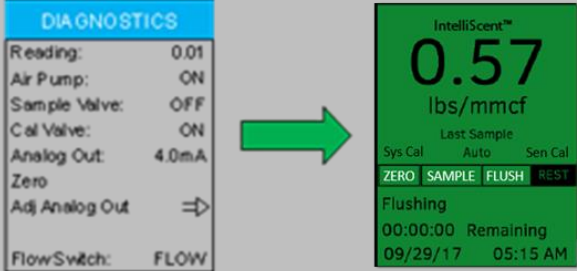
Step	Procedure	Illustration
6	<p>Once the reading has stabilized, press the Edit key on the gas sensor to store the zero value. If within limits, the gas sensor will show a Zero Cal Successful message, followed by the Apply Span message. Zero calibration is now complete.</p>	 <p>The illustration shows two circular displays. The left display shows a menu with options: 'UP/Prev', 'NEXT', 'Apply 0.57 Lbs/mmcF', '0.54 Counts = 1376', 'EDIT = Set Zero', and 'NEXT = Cal Span'. Below the menu are buttons for 'DN/In', 'EDIT', 'COM 1', and 'COM 2'. A green arrow points to the right display, which shows a green screen with the text 'ZERO CAL SUCCESS' and the same navigation buttons.</p>
7	<p>Turn off the regulator and disconnect the cylinder of zero air. Attach the cylinder of cal gas, and then turn on the regulator. Confirm that gas is flowing as before. The gas sensor value will begin to increase.</p>	 <p>The illustration shows a schematic of the gas sensor system. On the left is a brown gas cylinder connected to a regulator. The regulator is connected to a main gas line that splits into two paths. One path goes to a circular gas sensor unit with a digital display showing '0.57'. The other path goes to a smaller circular unit with a digital display showing '0.05'. Both units are connected to a central control panel with various gauges and valves.</p>
8	<p>Once the reading has stabilized (approx. 3 minutes), press the Edit key on the gas sensor to store the span value. If the span is within limits, the gas sensor will display a Span Cal Successful message. Span calibration is now complete.</p>	 <p>The illustration shows two circular displays. The left display shows a menu with options: 'UP/Prev', 'NEXT', 'Apply 0.57 Lbs/mmcF', '0.54 Counts = 1376', 'EDIT = Set Zero', and 'NEXT = Cal Span'. Below the menu are buttons for 'DN/In', 'EDIT', 'COM 1', and 'COM 2'. A green arrow points to the right display, which shows a green screen with the text 'SPAN CAL SUCCESS' and the same navigation buttons.</p>
9	<p>Exit the IntelliScent™ Diagnostics Menu by pressing the Next key. This will close the cal gas valve and restart the purge air flow.</p>	 <p>The illustration shows two screens. The left screen is titled 'DIAGNOSTICS' and lists the following: 'Reading: 0.01', 'Air Pump: ON', 'Sample Valve: OFF', 'Cal Valve: ON', 'Analog Out: 4.0mA', 'Zero', 'Adj Analog Out: =>', and 'FlowSwitch: FLOW'. A green arrow points to the right screen, which is the main IntelliScent™ display. It shows a large green '0.57 lbs/mmcF' reading, 'Last Sample', 'Sys Cal Auto Sen Cal', and a 'Flushing' timer showing '00:00:00 Remaining' and the date '09/29/17 05:15 AM'. At the bottom are buttons for 'ZERO', 'SAMPLE', 'FLUSH', and 'REST'.</p>
10	<p>Disconnect the gas cylinder and regulator. Gas sensor calibration is complete once the Cal Delay time expires.</p>	

5.1 IntelliScent™ User Menus

IntelliScent™ System Setup Menu

Figure 21: System Setup Menu

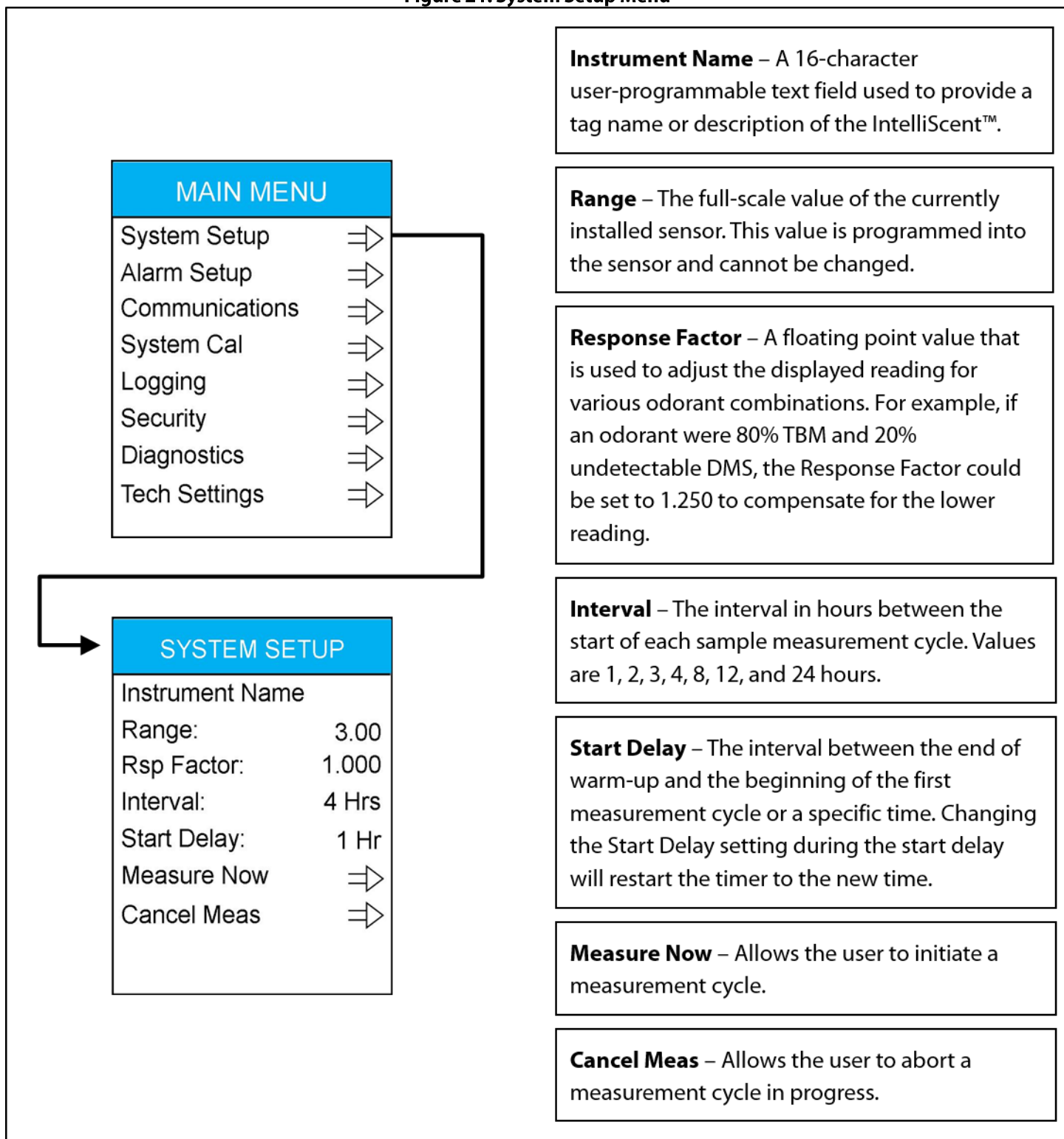

Figure 22: Alarm Setup Menu

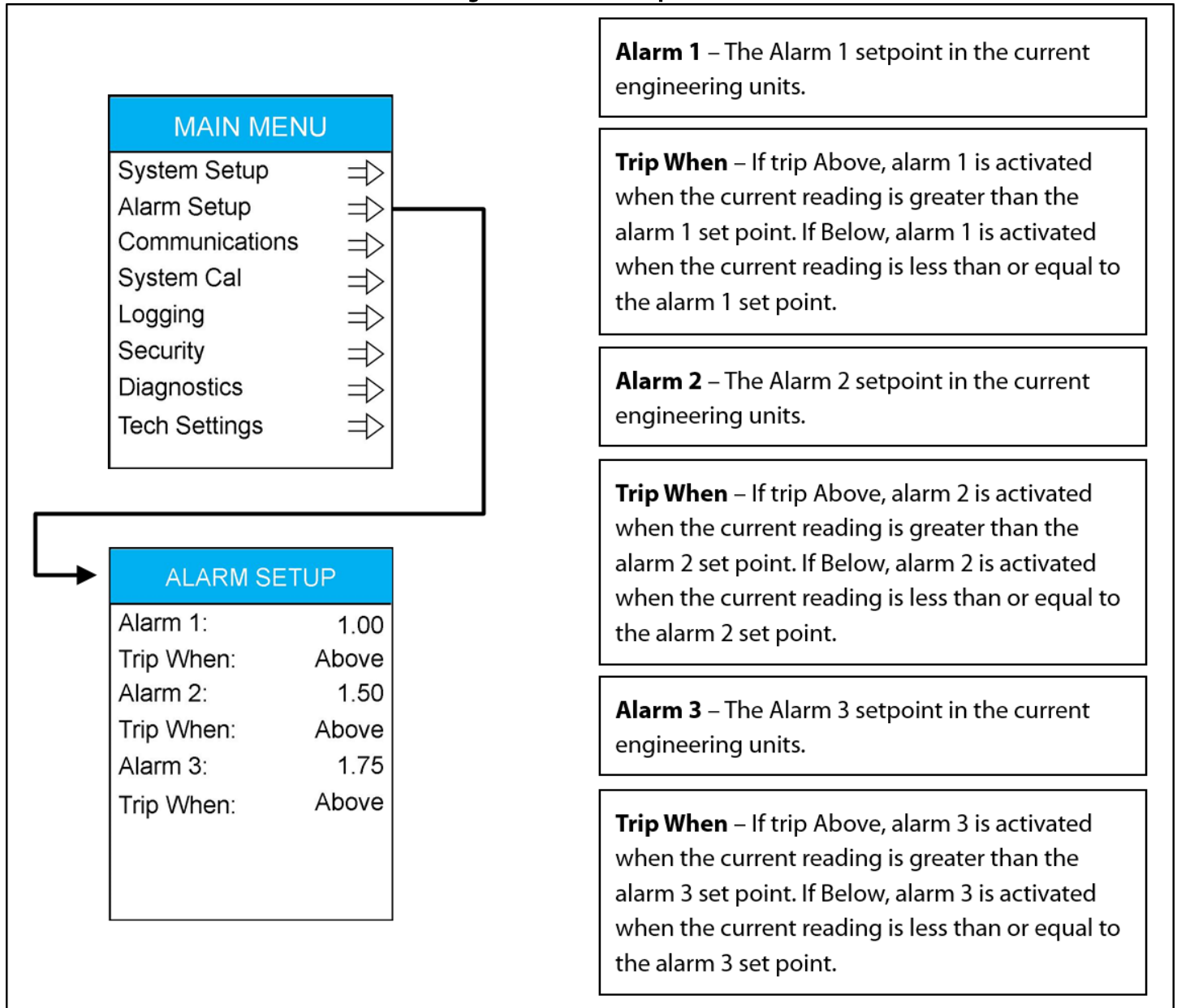

Figure 23: Communications Menu

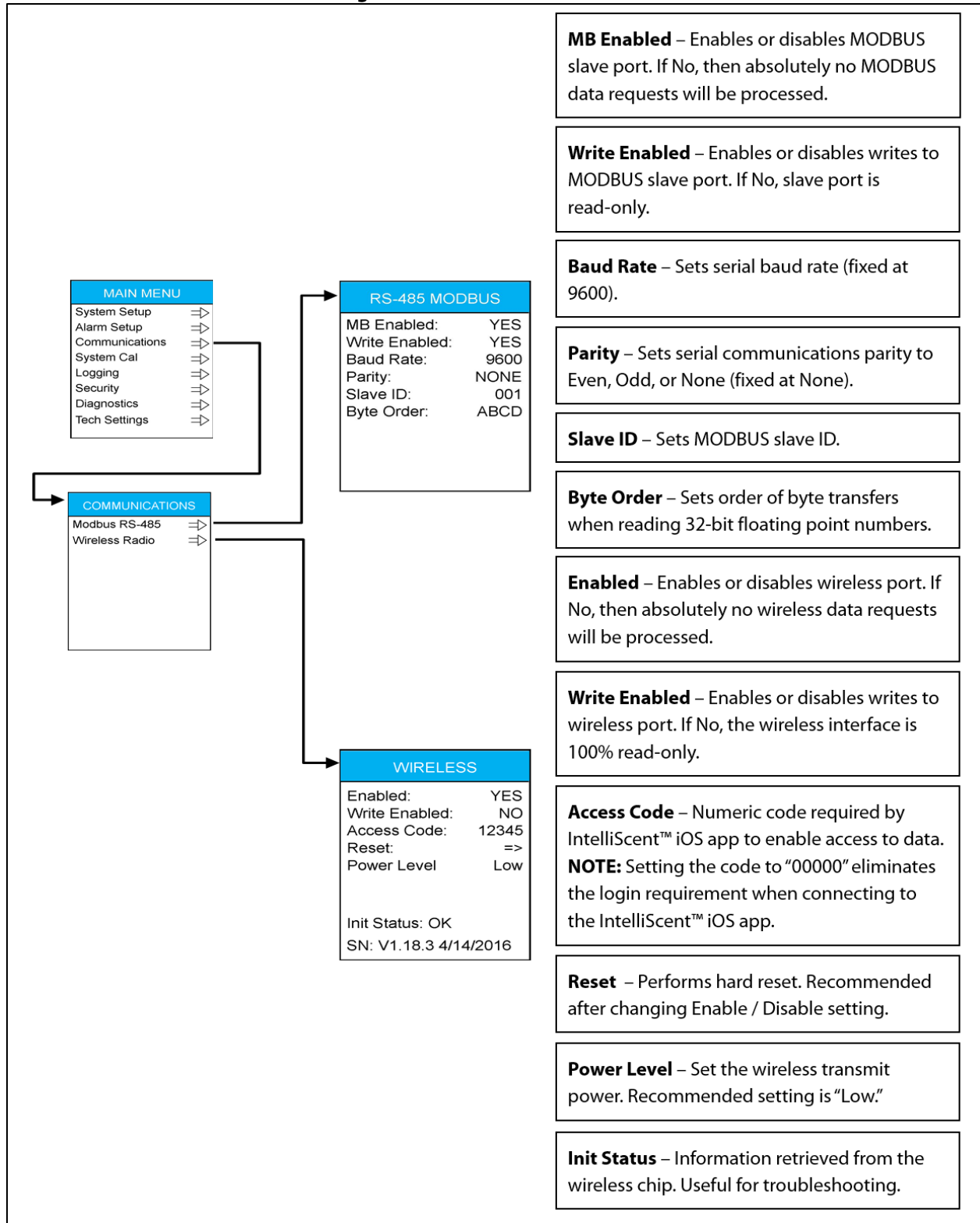

Figure 24: System Cal Menu

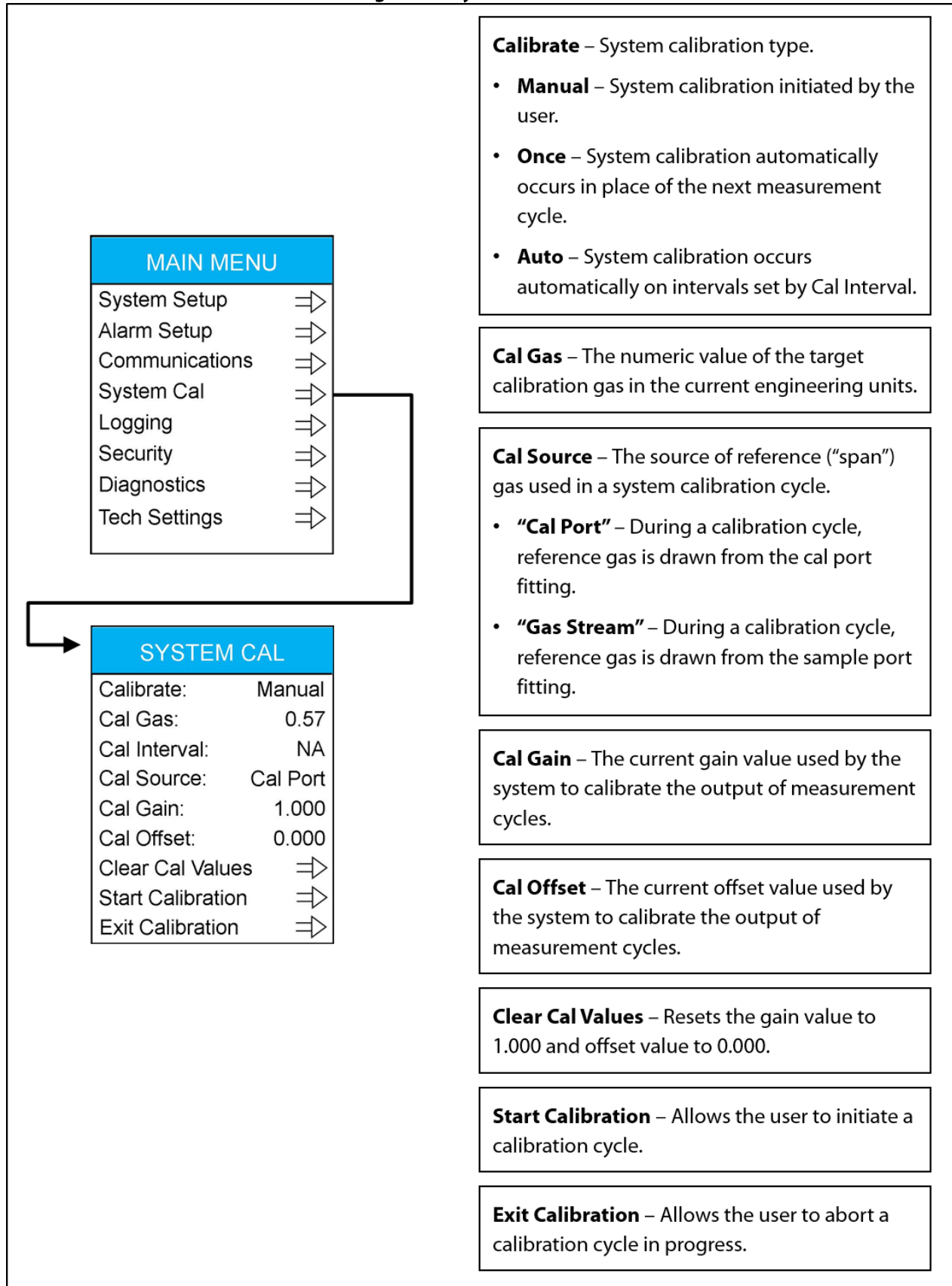

Figure 25: Logging Menu

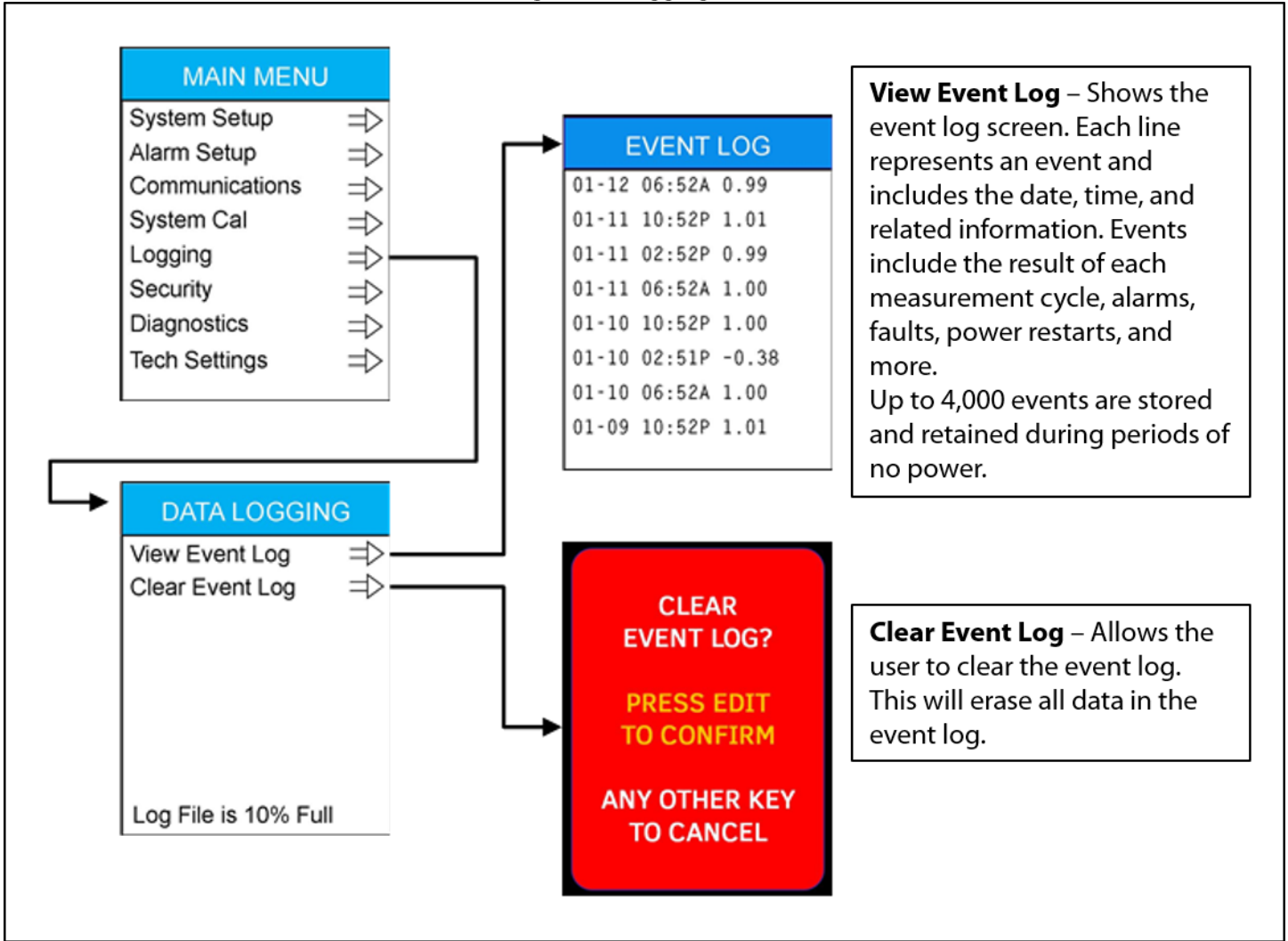

Figure 26: Security Menu

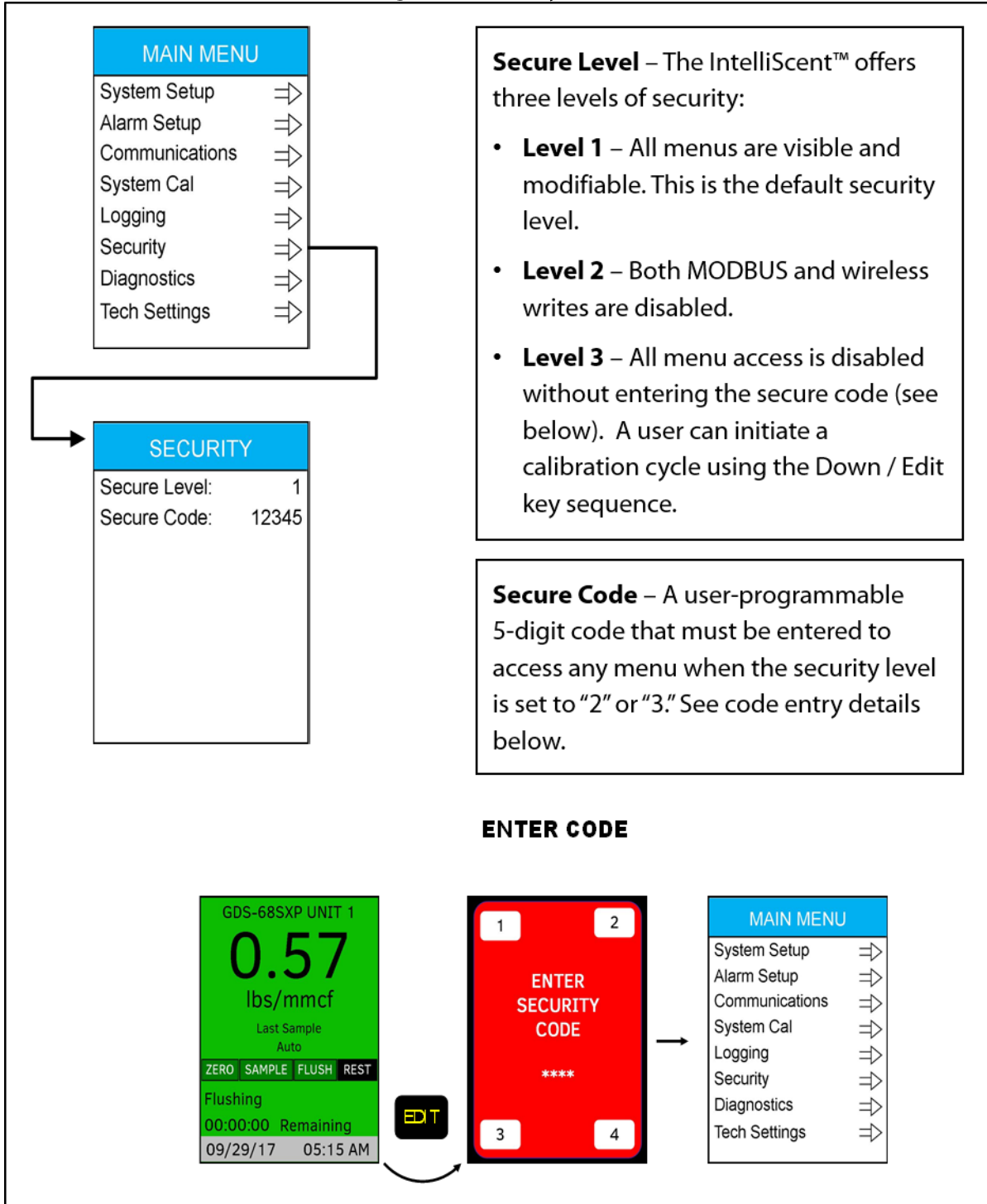

Figure 27: Diagnostics Menu

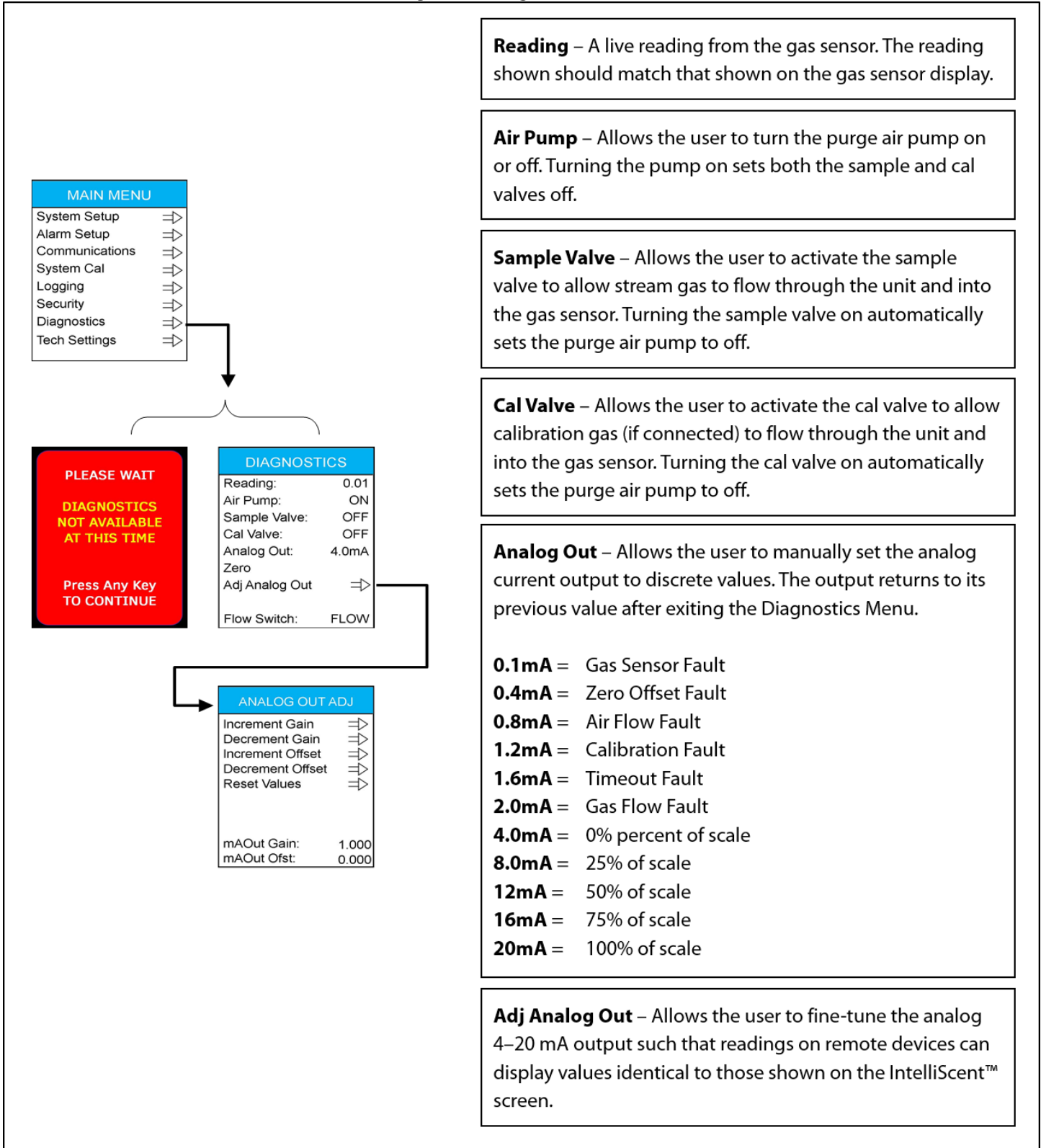
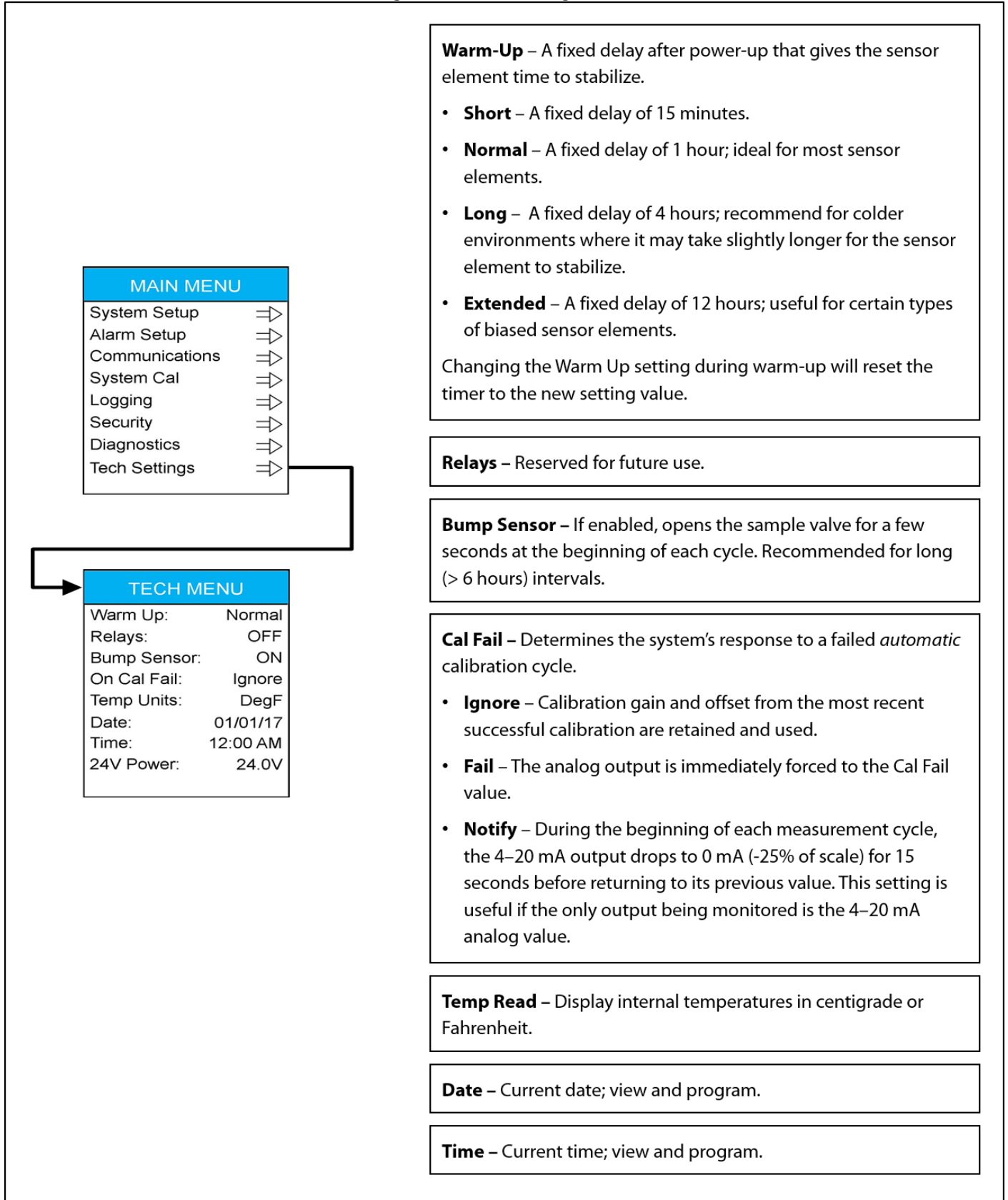

Figure 28: Tech Settings Menu



5.2 Gas Sensor User Menus



The IntelliScent™ gas sensor has a menu-driven user interface that allows the operator to review and adjust a wide range of settings.



In the IntelliScent™, channel 1 of the gas sensor measures the “raw sensor” gas level. Channel 2 is not used and is disabled. Do not enable channel 2 for any reason.



To access the Main Menu, activate the Edit key with the magnetic wand.

Figure 29: Gas Sensor User Menus

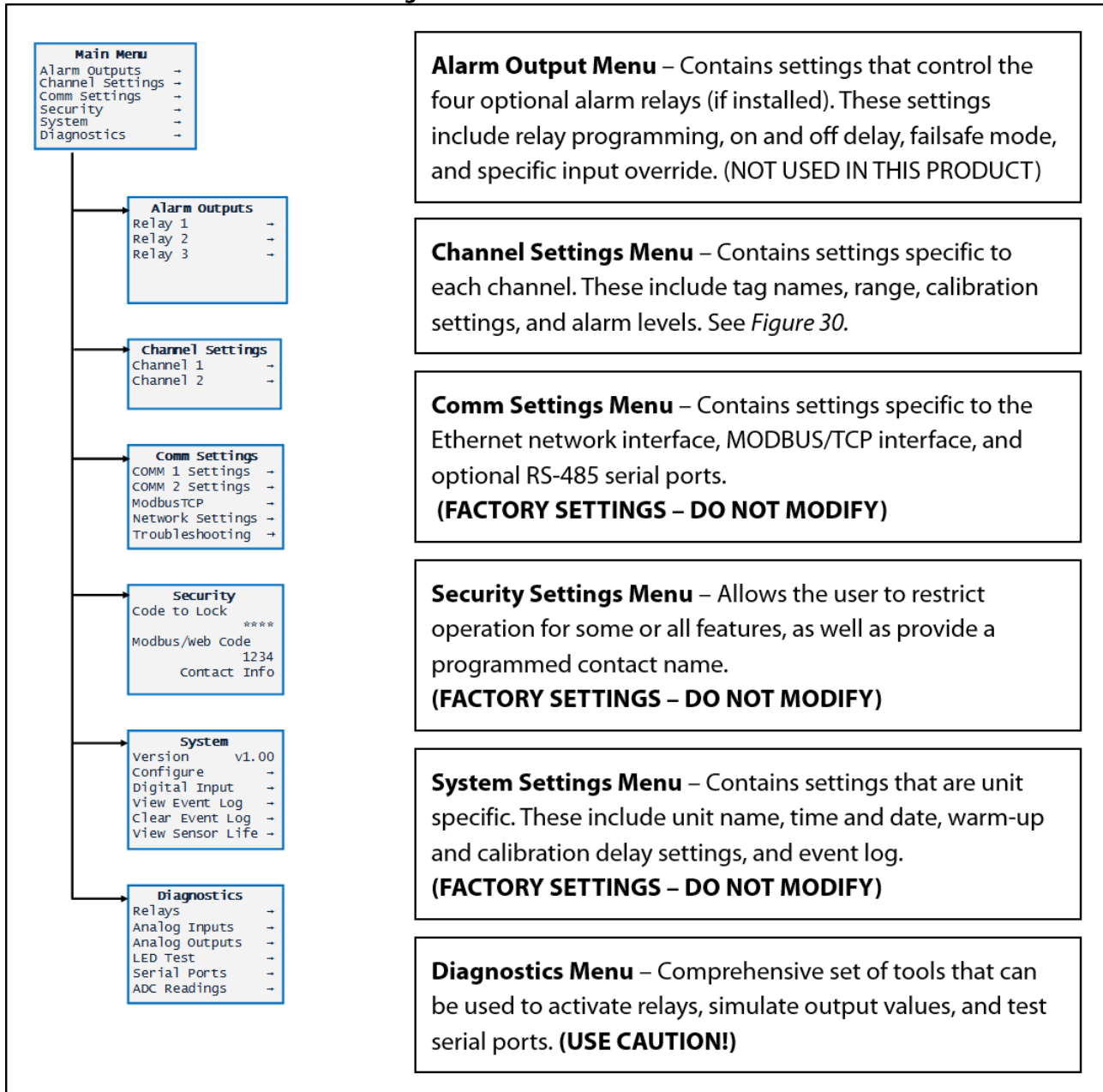

Gas Sensor Channel Settings Menu



The Channel Settings Menu allows the user to adjust individual channel or sensor-specific features. Data in the Channel Settings Menu is uploaded from sensor elements and written back to any local sensor element if changed in the menu.

Figure 30: Gas Sensor Channel Settings Menu

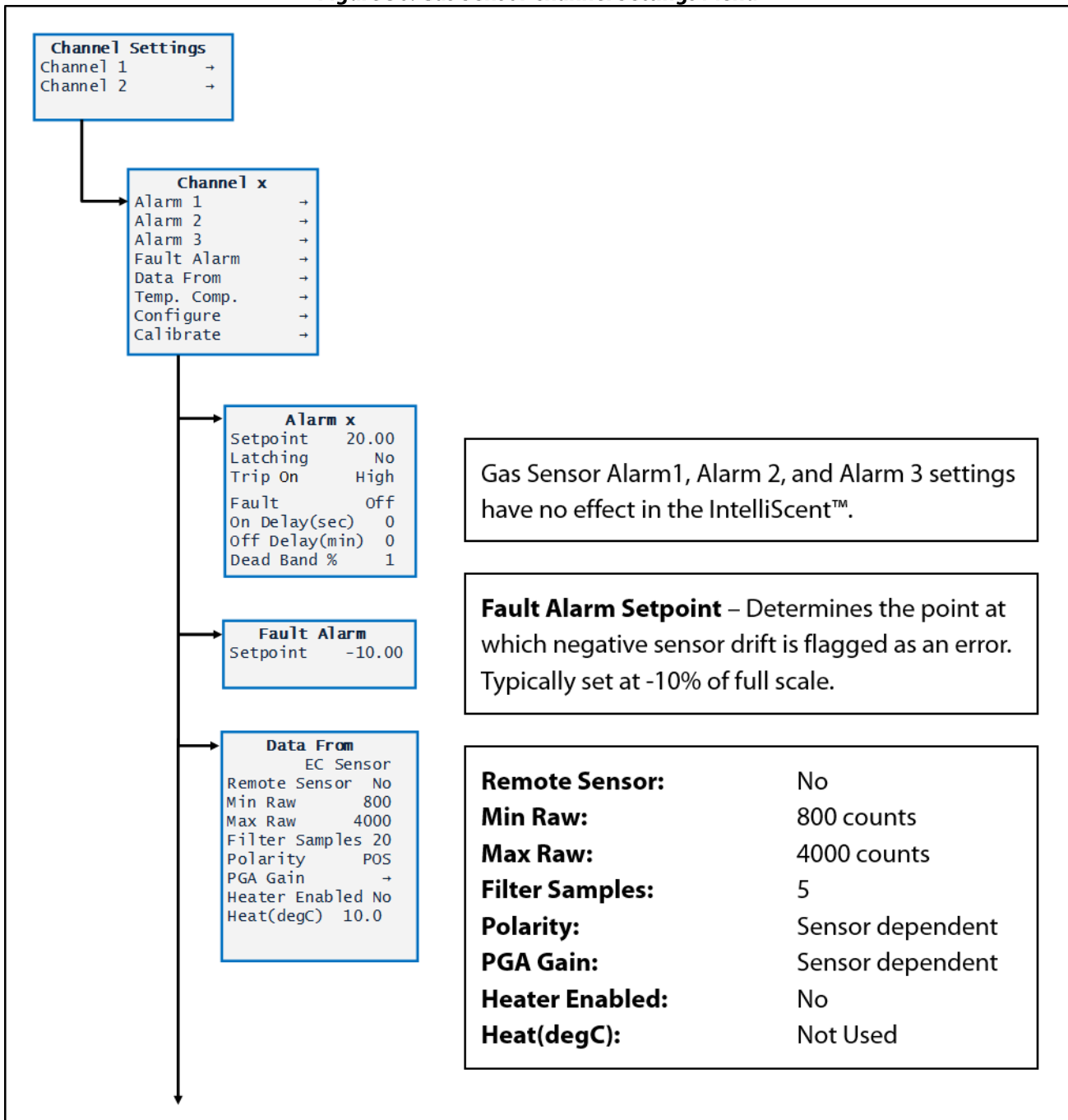

Figure 31: Gas Sensor Channel Settings Menu (Continued)

Temp. Comp.		
Temp	Gain	Offset
-40	1.00	+0.00
-30	1.00	+0.00
-20	1.00	+0.00
-10	1.00	+0.00
0	1.00	+0.00
+10	1.00	+0.00
+20	1.00	+0.00
+30	1.00	+0.00
+40	1.00	+0.00
+50	1.00	+0.00

Configure	
Hydrogen Sulfide	
E. Units	ppmH2S
Zero	0.00
Span	100.0
Decimal Points	0
Channel On?	Yes
Deadband (%)	0.00
Backup/Restore	→

Calibrate	
Offset	1.73
Gain	1.00
Cal Zero	0.00
Cal Span	100.0
Set Unity Gain	→

Temperature Compensation compensates for changes in sensor element output (gain) and zero value (offset) as sensor element temperature changes. These values are uploaded from the sensor element and should not be changed.

Tag Name:	User programmable text field
E. Units:	Engineering units from sensor element
Zero:	0.00
Span:	Max value for sensor element
Decimal Points:	Number of digits from sensor element
Channel On?:	YES
Dead band (%):	0%

Offset:	Calculated offset from last cal
Gain:	Calculated gain from last cal
Cal Zero:	Cal Zero Value for sensor cal
Cal Span:	Cal Span Value for sensor cal
Set Unity Gain:	Resets gain and offset to default

Gas Sensor Comm Settings Menu



The Comm Settings Menu allows the user to configure the RS-485 slave serial interface used by the IntelliScent™ master to read gas sensor real-time values and fixed data uploaded from the local sensor element.



DO NOT modify the Comm Settings unless instructed to do so by Welker personnel to assist in troubleshooting or gas sensor debugging.

Figure 32: Gas Sensor Comm Settings Menu

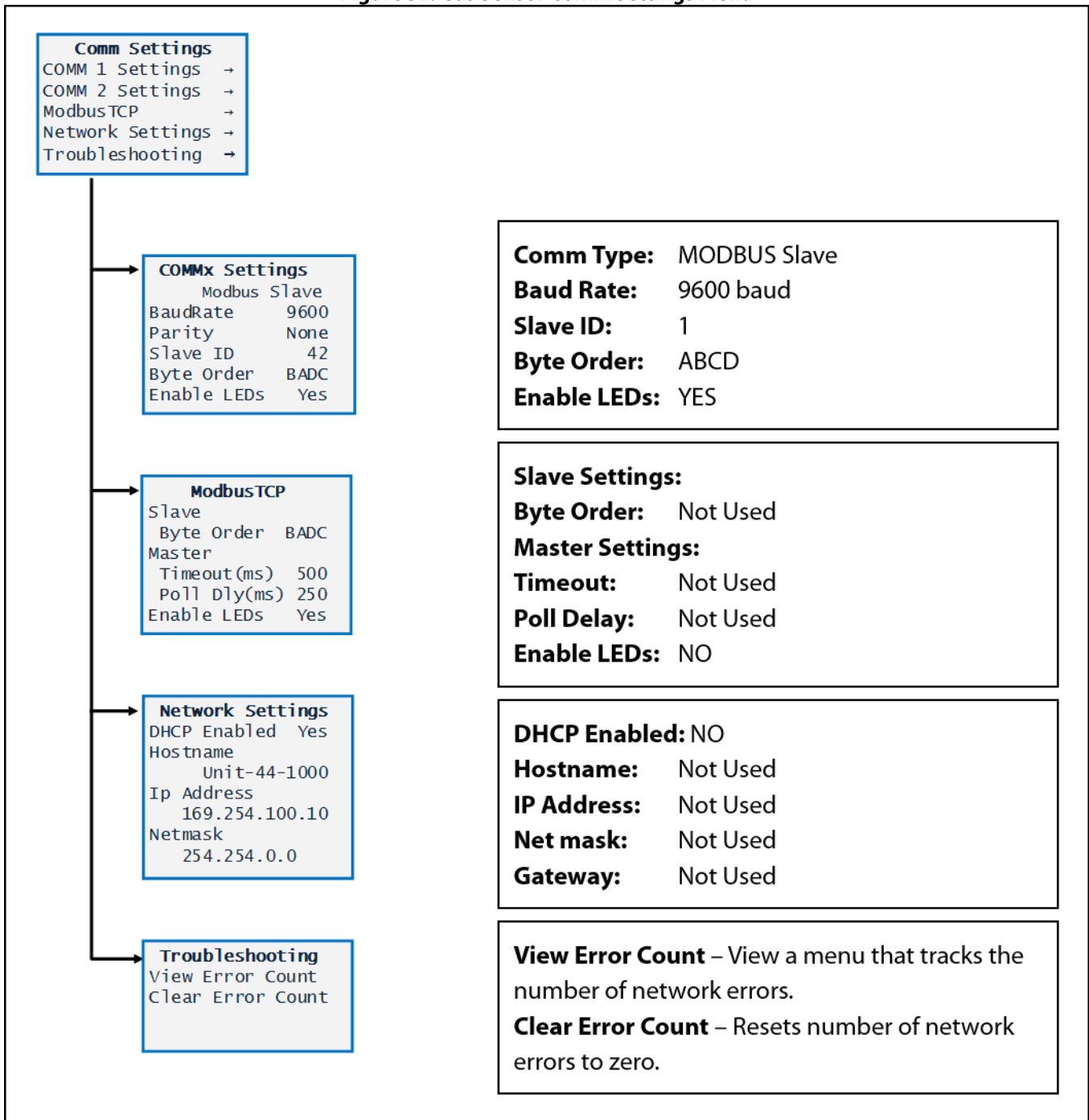

Gas Sensor System Settings Menu



The System Settings Menu allows the user to view or modify certain system settings.



Except for time and date, DO NOT modify the System Settings unless instructed to do so by Welker personnel to assist in troubleshooting or gas sensor debugging.

Figure 33: Gas Sensor System Settings Menu

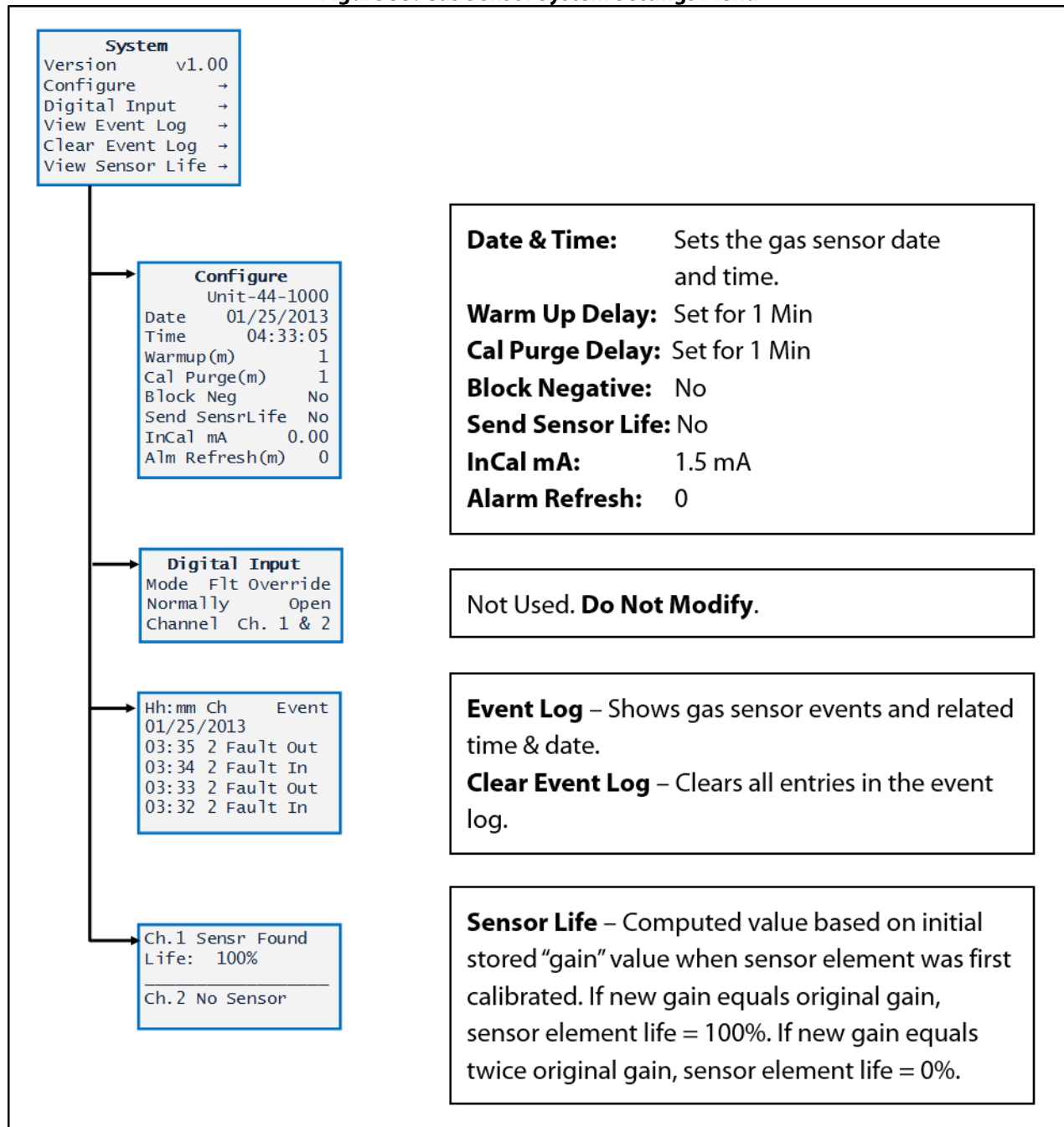

Gas Sensor Diagnostics Menu



The Diagnostics Menu provides tools for use during setup or testing.



Tests for optional features are not available if the feature is not installed.



Some of these tests may be useful in certain debugging operations.

Figure 34: Gas Sensor Diagnostics Menu

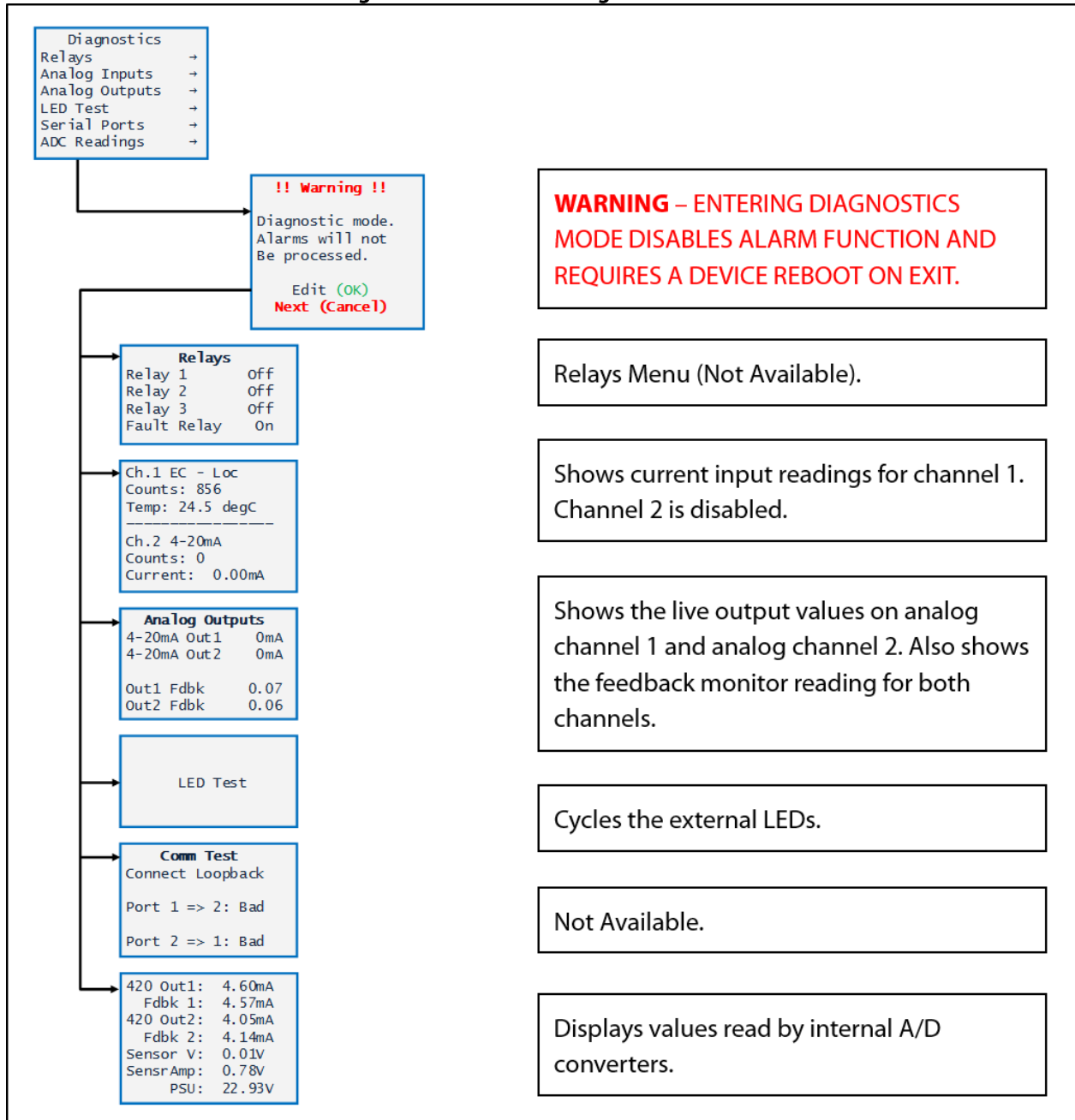

SECTION 6: MAINTENANCE

6.1 Before You Begin

1. **Welker recommends that the unit have standard maintenance every six (6) months under normal operating conditions.** In cases of severe service, dirty conditions, excessive usage, or other unique applications that may lead to excess wear on the unit, a more frequent maintenance schedule may be appropriate.
2. Prior to maintenance or disassembly of the unit, it is advisable to have a repair kit available for repairs of the system in case of unexpected wear.
3. The unit should be periodically inspected for the following: clogged or blocked air inlet or sample exhaust; moisture in the flow meter or flow switch; fault indication on the IntelliScent™ screen or gas sensor screen; excessive dirt inside the enclosure; and other generally undesirable conditions.
4. Standard maintenance for the IntelliScent™ consists of periodic checks on flow settings and sensor calibration.



Each time a gas sensor calibration is completed, a new sensor life reading will appear that gives an approximate indication of the remaining sensitivity.



Sensor life is not necessarily linear. Rapid reduction in the sensor life reading can be due to temperature extremes, high levels of target gas, the presence of certain gases that “poison” sensors, and other environmental factors.

5. Welker recommends having adjustable wrenches available for maintenance. Please note that the exact tools required may vary by model.

6.2 Inspecting the Inlet Filter



The inlet filter should be inspected every six to twelve (6–12) months.

1. Close sample inlet valve A (*Figure 2*).
2. Open filter drain valve B to discharge gas remaining inside the filter (*Figure 2*).
3. Using a wrench, remove the tubing connection between the bottom of filter drain valve B and the bulkhead fitting.
4. Unscrew the filter body and drain valve assembly.
5. Inspect the filter element for discoloration and moisture.
6. Replace the filter element if necessary.

6.3 Checking Flow Levels



Sample and air flow should always remain between 0.5 LPM and 0.75 LPM. While the exact value is not critical, if flow drops below 0.25 LPM, there is a chance that the flow switch will indicate a loss of flow during a sample measurement or calibration cycle.

To properly set the flow level:

1. With purge air flowing, adjust the flow meter valve so that the flow of purge air is approximately 0.5 LPM.
2. Enter the Diagnostics Menu and activate the sample valve.
3. With sample gas flowing, adjust the regulator so that sample flow is approximately 0.5 LPM.

6.4 Testing the Operation of Internal Components



The IntelliScent™ Diagnostics Menu can be used to activate the sample valve, cal valve, and air pump, as well as force the analog output and MODBUS output to pre-determined values for diagnostics and signal level confirmation. The Diagnostics Menu also shows the real-time status of the flow switch.



Turn the air pump on and off to confirm proper operation and ensure that it is not sticking open or closed (Figure 27).

6.5 Sensor Element Replacement



If a sensor element indicates Fault, does not respond to gas, or can no longer be calibrated, it should be replaced (Figure 35).

Figure 35: Sensor Element Replacement

Step 1: Remove DC power from the unit.

Step 2: Carefully disconnect the inlet and outlet connections on the sensor flow cell with two (2) adjustable wrenches.

Step 3: Unscrew the flow cell and sensor head cover, taking care not to dislodge the sensor element.

Step 4: Remove the old sensor element by pulling straight down (DO NOT unscrew sensor element).

Step 5: Inspect the sensor head cover and sensor element for any signs of moisture or damage.

Step 6: Install the new sensor element by aligning the arrow on the sensor label with the engraved arrow on the sensor head and pushing straight up.

Step 7: Reinstall the sensor head cover and flow cell, taking great care not to dislodge sensor element.

Step 8: Reconnect sample inlet and outlet tubing.

Step 9: Apply power to the unit and allow it to warm up for more than one (1) hour.

Step 10: Perform the gas sensor calibration, wait 10 minutes, and then perform a system calibration.

6.6 Hard Fault Conditions



The IntelliScent™ monitors flow rates and sensor element readings to detect problems. If a major fault occurs during a sample sequence, the 4–20 mA and MODBUS outputs will indicate one of the unrecoverable / critical fault conditions described in *Table 10*. If no critical fault occurs, the display and outputs will track the measured value.

Table 10: Critical Fault Conditions

Fault	Reason	% of Scale	Output (mA)	Range (0–3.00 lb/MMcf)	Range (0–50.0 mg/m ³)
Flow Switch Fault	Indicates that the flow switch did not drop out (possibly stuck “on”) during the “no-flow” interval between the zero and gas measurements.	-12.5%	2.0	“-0.37”	“-6.2”
Gas Flow Fault	Indicates that the flow switch measured more than 25 seconds of insufficient flow during the gas measurement cycle.	-15%	1.6	“-0.45”	“-7.5”
Calibration Fault	Indicates that a previous calibration failed if the “On Cal Fail” setting is set to “Fail.” If the “On Cal Fail” setting is set to “Ignore” or “Indicate,” this fault will never occur.	-17.5%	1.2	“-0.52”	“-8.7”
Air Flow Fault	Indicates that the flow switch measured more than 25 seconds of insufficient flow during the zero or purge measurement cycle.	-20%	0.8	“-0.60”	“-10.0”
Sensor Fault	Indicates that the gas sensor indicated a sensor fault at some point during the measurement cycle.	-22.5%	0.4	“-0.67”	“-11.2”



Overrange fault will immediately abort the sample cycle and purge the sensor element to remove overrange gas from the flow cell.

6.7 Warning Conditions



The IntelliScent™ tracks a number of parameters during each measurement cycle and records any deviations in the event log and in the status flags associated with each measurement or calibration cycle.



Warnings DO NOT cause the output to go into fault but should be checked during maintenance to determine whether the sensor element needs to be replaced.

Table 11: Warning Conditions

Warning	Reason	% of Scale	Output (mA)
Offset Warning	Zero value measured at beginning of cycle exceeds +/- 10% of scale. Recalibrate the gas detector.	N/A	Normal
Overrange Warning	Gas sensor reading exceeded 100% of full-scale during measurement cycle. Check the span setting.	N/A	Normal
Zero Timeout Warning	Zero measurement interval exceeded maximum allowed time interval. Check the sensor element.	N/A	Normal
Measurement Timeout Warning	Gas measurement interval exceeded maximum allowed time interval. Check the sensor element.	N/A	Normal
Recovery Timeout Warning	Recovery from measurement to 10% of scale exceeded maximum allowed time. Check the sensor element.	N/A	Normal

6.8 Cold Weather Operation



The IntelliScent™ is designed for accurate and reliable operation across a wide range of operating conditions. Once running, the IntelliScent™ generates enough heat to maintain operation down to 0 °F ambient and below.



If the unit has been powered off, care should be taken during startup to ensure the air purge temperature is above 32 °F prior to the application of DC power.



Welker recommends the optional 200 W AC heater be turned on for several hours prior to applying DC power to the system to reduce the possibility of pump damage in extremely cold weather.



Welker recommends removing the sensor element and storing it in a temperature-controlled location if the unit is to be left unpowered during extremely cold weather.

6.9 Restore Factory Settings



If an operator needs to restore all configurable settings back to factory default, the IntelliScent™ includes a Restore Factory Settings feature (aka “cold boot”).

1. To restore all settings to their default condition, hold the magnetic wand over the Edit key when the splash screen appears after applying power (*Figure 36*).

Figure 36: Restore Factory Settings Procedure

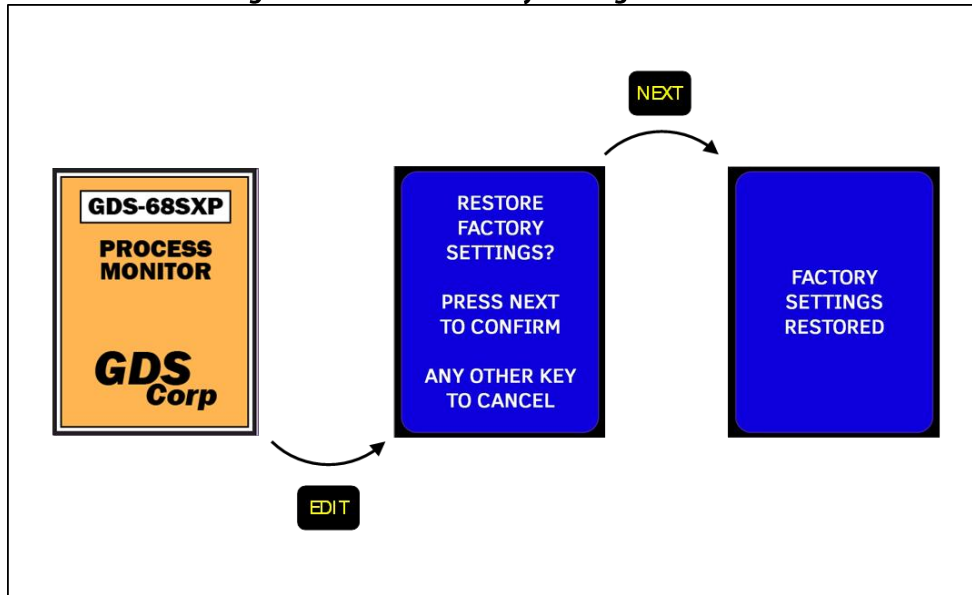

2. Once the Restore Factory Settings screen appears, hold the magnetic wand over the Next key until the Factory Settings Restored screen appears. The IntelliScent™ will reboot with all settings reset to factory defaults.



Factory cold boot does not reset the system serial number, wireless status, or certain other factory-programmed variables.



Since the full-scale range, number of decimal points, and engineering units are retrieved from the sensor element installed in the gas sensor, those values will be automatically restored. Other settings, such as local alarm levels and external communications parameters, may need to be reprogrammed.

6.10 Troubleshooting

Table 1: Troubleshooting		
Issues	Possible Causes	Solutions
The IntelliScent™ is not working.	The IntelliScent™ is not turned on.	Ensure that a DC 12 V electrical supply is connected to the explosion-proof box.
	An incorrect power type and/or voltage level is supplied to the IntelliScent™.	An incorrect power type and/or voltage can cause permanent damage to the unit. Contact Welker for assistance.
There is a negative reading on the IntelliScent™ display.	There is an error in the most recent measurement cycle.	See <i>Section 6.6, Hard Fault Conditions</i> , to determine the cause of the error.
	During the power-up procedure, a fault or overrange occurred due to certain toxic sensor elements, indicating off-scale low or high at power-up and quickly drifting toward zero.	This is normal behavior and should resolve itself in less than an hour for most sensor elements.
	A Continuous Fault indication occurs due to moisture buildup or a faulty sensor element.	Remove the sensor element and examine it for moisture or discoloration. Replace the sensor element if it shows signs of moisture buildup or discoloration. Note: A Fault indication generally indicates the useful life of the sensor element is exhausted.
There is a fault indication on the gas sensor display.	The sensor element has been left unpowered for more than three (3) months, causing accelerated degradation and/or permanent loss of sensitivity.	Power should be applied periodically to the sensor element during periods of inactivity, or the sensor element should be removed and stored in an appropriate temperature-controlled location until the system is ready for use.
	If the sensor reading during zero calibration exceeds the upper limit of zero, the sensor element is defective.	Remove the sensor element and insert a suitable replacement.
There is a failed gas sensor calibration.	If the sensor reading during span calibration is too low, the sensor element may be defective.	It may be possible to temporarily continue operation by increasing the sensor controller preamp gain. If this fails, remove the sensor element and insert a suitable replacement.
	Calibration gas may be out of date, defective, or depleted.	Replace the calibration gas with a new cylinder.
There is a failed system calibration.	The purge air inlet may be clogged.	Remove any dirt, insect nests, or other obstructions from the purge air inlet.

Table 12: IntelliScent™ Troubleshooting (Continued)

Issues	Possible Causes	Solutions
<p>The analog 4–20 mA output is not working or not accurate.</p>	<p>The output wiring connection may not be secure.</p> <p>The readings do not match.</p> <p>The readings are “Off.”</p>	<p>Ensure that the output wiring connection to the 4–20 mA output terminal is properly connected.</p> <p>Verify that the full-scale range of the IntelliScent™ and input range of the receiving controller or DCS is identical. Use the Diagnostics Menu to force the 4–20 mA output to specific values, and then confirm the reading on the remote controller or DCS (<i>Figure 27</i>).</p> <p>Use the Analog Adjustment function in the Diagnostics Menu to adjust the 4–20 mA output to match the specific input load resistor of the receiving controller or DCS (<i>Figure 27</i>).</p>
<p>MODBUS data is incorrect or missing.</p>	<p>The MODBUS polarity may be incorrect.</p> <p>Baud Rate, Parity, Data Bits, or Slave ID values may be incorrect.</p> <p>There may be multiple MODBUS slaves on the same network.</p> <p>The MODBUS master may be receiving data from an incorrect data register.</p> <p>If you are reading the digital counts value, the controller Min and Max count settings may be incorrect.</p> <p>If you are reading the MODBUS floating point, the Byte Order setting may be showing incorrect data.</p>	<p>Swap “A” and “B” if unsure. No damage will occur.</p> <p>Verify that each value has the correct settings in place.</p> <p>Ensure that there are no other MODBUS slaves on the same network with similar Slave ID settings.</p> <p>Verify that the MODBUS master is requesting data from the correct data register.</p> <p>Min counts should be 800, which corresponds to 4 mA, and Max counts should be 4000, which corresponds to 20 mA.</p> <p>Verify that the Byte Order setting is accurate. Note: It may be necessary to try all four settings to determine which one works.</p>
<p>The IntelliScent™ display is blank.</p>	<p>No DC power is being supplied to the input supply terminals.</p> <p>The ribbon cable has come unplugged.</p>	<p>Verify that there is DC power at the input supply terminals on back of the IntelliScent™ board assembly.</p> <p>Ensure that the ribbon cable is plugged into the display board and pump board.</p>

Table 12: IntelliScent™ Troubleshooting (Continued)

Issues	Possible Causes	Solutions
<p>The gas sensor display is blank.</p>	<p>No DC power is being supplied to the input supply terminals.</p> <p>The wiring between the gas sensor and the IntelliScent™ board may be incorrect or loose.</p>	<p>Verify that there is DC power at the input supply terminals on back of the IntelliScent™ board assembly.</p> <p>Verify that the power and MODBUS wiring between the IntelliScent™ board and the gas sensor are correct and tight.</p>
<p>There is a System Comm Timeout message.</p>	<p>The MODBUS wiring is incorrect.</p> <p>Baud Rate and Slave ID programming is incorrect.</p>	<p>Verify that the MODBUS wiring between the IntelliScent™ board and the gas sensor is correct.</p> <p>Ensure that the gas sensor Comm 1 serial port is programmed for the correct Baud Rate and Slave ID.</p>
<p>There is an IntelliScent™ power fail message.</p>	<p>DC input voltage is too high or too low.</p>	<p>Ensure that the correct voltage is being applied to the IntelliScent™.</p> <p>Note: Once a power fail occurs, the system must be restarted to restore operation.</p>

APPENDIX A: MODBUS REGISTERS



The IntelliScent™ features a set of user-accessible MODBUS registers that can provide a complete snapshot of the system configuration. This includes all real-time data, preset zero, span and calibration values, and user-programmable text.



MODBUS Settings: MODBUS RTU 9600 8N1

Table A1: IntelliScent™ MODBUS Registers

Description	Register	Write	Details
WRITE REGISTERS			
Note: Writes will have no effect if MODBUS Write Enable is set to “No”			
Start Measurement Cycle	1000	W	Writing a “1” to this register will start a measurement cycle
Stop Measurement Cycle	1010	W	Writing a “1” to this register will cancel a measurement cycle in progress
Start Calibration Cycle	1020	W	Writing a “1” to this register will start a calibration cycle
Stop Calibration Cycle	1030	W	Writing a “1” to this register will cancel a calibration cycle in progress
Set Calibration Source = Port	1040	W	Writing a “1” to this register will set the calibration gas source to “Cal Port”
Set Calibration Source = Stream	1050	W	Writing a “1” to this register will set the calibration gas source to “Sample Stream”
READ REGISTERS (Realtime)			
Current Counts	31001	N/A	12-bit value; 800 = 4 mA, 4000 = 20 mA
Current Reading	31002	N/A	32-Bit floating-point value
Current Alarm Status	31004	N/A	“1” = Alarms Clear “2” = Alarm 1 Active “3” = Alarm 2 Active “4” = Alarm 3 Active “5” = Fault Alarm Active
Current Mode	31005	N/A	Integer (Contact Welker for details)
Current Time Hour	31006	N/A	Decimal value of current hour
Current Time Minute	31007	N/A	Decimal value of current minute
Current Time AM/PM	31008	N/A	“0” = AM “1” = PM
Current Time Month	31009	N/A	Decimal value of current months
Current Time Day	31010	N/A	Decimal value of current day
Current Time Year	31011	N/A	Decimal value of current year
Currently Measuring	31012	N/A	“1” = Measurement cycle
Currently Calibrating	31013	N/A	“1” = Calibration cycle
Manual Operation Allowed	31014	N/A	“1” = Ready
Hours Remaining to Sample	31015	N/A	Decimal value of hours to go to next sample
Minutes Remaining to Sample	31016	N/A	Decimal value of minutes to go to next sample
Seconds Remaining to Sample	31017	N/A	Decimal value of seconds to go to next sample

Table A1: IntelliScout™ MODBUS Registers (Continued)

Description	Register	Write	Details
READ REGISTERS (Configuration)			
Full Scale Range	31021	N/A	32-Bit floating-point value
System Response Factor	31023	N/A	32-Bit floating-point value
System Cal Gain Value	31025	N/A	32-Bit floating-point value
System Cal Offset Value	31027	N/A	32-Bit floating-point value
System Sample Interval	31029	N/A	"1" = One Hour "2" = Two Hours "3" = Three Hours "4" = Four Hours "5" = Six Hours "6" = Eight Hours "7" = Twelve Hours "8" = Twenty-four Hours
System Decimal Points	31030	N/A	"0" = "000" "1" = "00.0" "2" = "0.00"
System Alarm 1 Value	31031	N/A	32-Bit floating-point value
System Alarm 1 Type	31033	N/A	"0" = Alarm above "1" = Alarm below
System Alarm 2 Value	31034	N/A	32-Bit floating-point value
System Alarm 2 Type	31036	N/A	"0" = Alarm above "1" = Alarm below
System Alarm 3 Value	31037	N/A	32-Bit floating-point value
System Alarm 3 Type	31039	N/A	"0" = Alarm above "1" = Alarm below
Firmware Version	31040	N/A	Decimal value
Security Level	31041	N/A	"1" = Low Security "2" = Medium Security "3" = High Security
Modbus Write Enable	31042	N/A	"0" = MODBUS writes disabled "1" = MODBUS writes enabled

Table A1: IntelliScent™ MODBUS Registers (Continued)

Description	Register	Write	Details
READ REGISTERS (Last Sample)			
Last Sample Reading	31051	N/A	32-Bit floating-point value
Last Sample Error Flags	31053	N/A	Bit 0 = Sensor Fault Bit 1 = Flow Switch Fault Bit 2 = Gas Flow Fault Bit 3 = Air Flow Fault Bit 4 = Reserved (0) Bit 5 = Reserved (0) Bit 6 = Reserved (0) Bit 7 = Reserved (0) Bit 8 = Offset Warning Bit 9 = Overrange Warning Bit 10 = Zero Timeout Warning Bit 11 = Sample Timeout Warning Bit 12 = Recovery Timeout Warning Bit 13 = Gas Sensor Warning Bit 14 = Reserved (0) Bit 15 = Reserved ("0")
Last Sample Raw Zero	31054	N/A	32-Bit floating point value
Last Sample Raw Measurement	31056	N/A	32-Bit floating point value
Last Sample Time Hour	31058	N/A	Decimal value of hour at last sample
Last Sample Time Minute	31059	N/A	Decimal value of minute at last sample
Last Sample AM/PM	31060	N/A	"0" = AM "1" = PM
Last Sample Time Month	31061	N/A	Decimal value of month at last sample
Last Sample Time Day	31062	N/A	Decimal value of day at last sample
Last Sample Time Year	31063	N/A	Decimal value of year at last sample
Last Sample Zero Time	31064	N/A	Decimal value of time to complete zero measurement
Last Sample Meas Time	31065	N/A	Decimal value of time to complete sample measurement
Last Sample Flush Time	31066	N/A	Decimal value of time to complete flush to 10% of scale
Last Sample Gas Flow Status	31067	N/A	"0" = Flow Error "1" = Flow OK
Last Sample Air Flow Status	31068	N/A	"0" = Flow Error "1" = Flow OK
Last Sample Sensor Temperature	31069	N/A	32-Bit floating point value
Last Sample DC Volts	31071	N/A	32-Bit floating point value
Last Sample Sequence Number	31073	N/A	Decimal count of samples since power-up

Table A1: IntelliScent™ MODBUS Registers (Continued)

Description	Register	Write	Details
READ REGISTERS (Last Cal)			
Last Cal Span Value	31081	N/A	32-Bit floating-point value
Last Cal Error Flags	31083	N/A	Bit 0 = Sensor Fault Bit 1 = Flow Switch Fault Bit 2 = Gas Flow Fault Bit 3 = Air Flow Fault Bit 4 = Reserved (0) Bit 5 = Reserved (0) Bit 6 = Cal Zero Calculation Fault Bit 7 = Cal Span Calculation Fault Bit 8 = Offset Warning Bit 9 = Overrange Warning Bit 10 = Zero Timeout Warning Bit 11 = Sample Timeout Warning Bit 12 = Recovery Timeout Warning Bit 13 = Gas Sensor Warning Bit 14 = Reserved (0) Bit 15 = Reserved ("0")
Last Cal Raw Zero	31084	N/A	32-Bit floating point value
Last Cal Raw Measurement	31086	N/A	32-Bit floating point value
Last Cal Time Hour	31088	N/A	Decimal value of hour at last cal
Last Cal Time Minute	31089	N/A	Decimal value of minute at last cal
Last Cal AM/PM	31090	N/A	AM or PM indicator
Last Cal Time Month	31091	N/A	Decimal value of month at last cal
Last Cal Time Day	31092	N/A	Decimal value of day at last cal
Last Cal Time Year	31093	N/A	Decimal value of year at last cal
Last Cal Zero Time	31094	N/A	Decimal value of time to complete zero measurement
Last Cal Meas Time	31095	N/A	Decimal value of time to complete sample measurement
Last Cal Flush Time	31096	N/A	Decimal value of time to complete flush to 10% of scale
Last Cal Gas Flow Status	31097	N/A	"0" = Flow Error "1" = Flow OK
Last Cal Air Flow Status	31098	N/A	"0" = Flow Error "1" = Flow OK
Last Cal Sensor Temperature	31099	N/A	32-Bit floating point value
Last Cal DC Volts	31101	N/A	32-Bit floating point value
Last Cal Gain	31103	N/A	32-Bit floating point value
Last Cal Offset	31105	N/A	32-Bit floating point value
Last Cal Sequence Number	31107	N/A	Decimal count of calibrations since power-up

Table A1: IntelliScent™ MODBUS Registers (Continued)

Description	Register	Write	Details
READ REGISTERS (Cal Config)			
Calibration Type	31121	N/A	"1" = Manual calibration "2" = Once calibration "3" = Automatic calibration
Cal Span Value	31122	N/A	32-Bit floating-point value
Cal Source	31124	N/A	"1" = Sample Stream "2" = Cal Port
READ REGISTER (Cal Config)			
Gas Sensor Reading	31201	N/A	Gas sensor current counts (0–4000, 800 = "0")
Gas Sensor Reading	31202	N/A	32-Bit floating-point value
Gas Sensor Sensor Life	31204	N/A	Sensor element life (0–100)
READ REGISTER (Ascii Text)			
Instrument Name	41001	N/A	20-character packed string ("IntelliScent™")
Engineering Units	41011	N/A	10-character packed string ("lb/mmcf")
Unit Serial Numbers	41016	N/A	10-character packed string ("GDS100001")

APPENDIX B: GAS SENSOR FACTORY DEFAULT SETUP

Gas Sensor Factory Default Setup



Values shown are for units configured for a range of 0–50 mg/m³. For alternative ranges, modify the Span, Engineering Units, Cal Span Value, and Alarm Level settings as necessary (Figure 30 and Figure 31).

Table B1: Gas Sensor Factory Default Setup

Menu	Setting	Value
Alarm Outputs Menu		
Relay 1, Relay 2, Relay 3	Alarm 1	Off
	Alarm 2	Off
	Alarm 3	Off
	Fault	Off
Channel Settings Menu		
Channel 1		
Alarm 1, Alarm 2, Alarm 3	Setpoint	<Full Scale>
	Latching	No
	Trip On	High
	On Delay	0 (None)
	Off Delay	0 (None)
	Deadband	1%
Fault Alarm	Setpoint	-10% of Scale
Data From	Sensor Type	EC Sensor
	Min Raw	800
	Max Raw	4000
	Filter	30
	Polarity	POS
	PGA Gain	<TBD>
	Heater En.	No
	Heat (degC)	10.00
	Local Cal?	Yes
Temperature Comp (°C)		
-40	Gain / Offset	<TBD>
-30	Gain / Offset	<TBD>
-20	Gain / Offset	<TBD>
-10	Gain / Offset	<TBD>
0	Gain / Offset	<TBD>
+10	Gain / Offset	<TBD>
+20	Gain / Offset	<TBD>
+30	Gain / Offset	<TBD>
+40	Gain / Offset	<TBD>
+50	Gain / Offset	<TBD>

Table B1: Gas Sensor Factory Default Setup (Continued)

Menu	Setting	Value
Configure	Tag Name	Raw Sensor
	Eunits	<TBD>
	Zero	0
	Span	<TBD>
	Decimal Points	<TBD>
	Channel On?	Yes
	Deadband	0%
Calibrate	In-Cal mA	1.5 mA
	Cal Offset	<TBD>
	Cal Gain	<TBD>
	Cal Zero	0.0
Channel 2	Cal Span	<TBD>
	Channel On?	No
Comm Settings Menu		
Comm 1	Type	MB Slave
	Baud Rate	9600
	Parity	None
	Timeout	500
	Poll Delay	250
	Byte Order	ABCD
	Enable LEDs	No
Comm 2	Type	MB Slave
	Baud Rate	9600
	Parity	None
	Timeout	500
	Poll Delay	250
	Byte Order	BADC
	Enable LEDs	No
MODBUS / TCP	Slave	
	Byte Order	BADC
	Master	
	Timeout	500
	Poll Delay	250
Network Settings	Enable LEDs	Yes
	DHCP Enabled?	Yes
	Hostname	IntelliScent™
	IP Address	N/A
	Netmask	N/A
	Gateway	N/A

Table B1: Gas Sensor Factory Default Setup (Continued)

Menu	Setting	Value
Security Menu		
Configure	System Name	IntelliScent™
	Date	Date
	Time	Time
	Warmup (m)	1
	Cal Purge (m)	3
	Block Negative	No
	Send Sensor Life	No
Digital Input	Alarm Refresh	0
	Mode	Alarm Reset

APPENDIX C: SYSTEM EVENTS

System Events

Table C1: System Events		
Event	Description	Recommended Action
"0.00"	Value from reading (no text)	Result of successful measurement
A1 IN	Alarm 1 In (made active)	User-defined
A1 OT	Alarm 1 Out (made inactive)	User-defined
A2 IN	Alarm 2 In (made active)	User-defined
A2 OT	Alarm 2 Out (made inactive)	User-defined
A3 IN	Alarm 3 In (made active)	User-defined
A3 OT	Alarm 3 Out (made inactive)	User-defined
FLTIN	Fault Alarm In (made active)	User-defined
FLTOT	Fault Alarm Out (made inactive)	User-defined
CALOK	Calibration cycle completed successfully	Normal operation
CALCN	Calibration cycle cancelled	User action
CALCL	Calibration values reset (Gain = 1.00)	User action
CALSA	Calibration cycle started automatically	None
CALSM	Calibration cycle started via MODBUS	User action
CALSU	Calibration cycle started via user from main menu	User action
CALSW	Calibration cycle started via wireless interface	User action
CBOOT	Unit performed Cold Boot	User reset to factory default values.
CFAIR	Calibration FAIL (purge air flow)	No purge air during calibration cycle. Check air pump and flame arrestors.
CFFSW	Calibration FAIL (stuck flow switch)	Flow switch stuck in open position. Check in diagnostics mode. Replace if necessary.
CFGAS	Calibration FAIL (span gas flow)	No span flow during calibration cycle. Check cal cylinder or source of cal gas.
CFSEN	Calibration FAIL (sensor fault)	Sensor fault during calibration cycle. Check or recalibrate sensor element.
CFZER	Calibration FAIL (sensor resting zero exceeds limits)	Resting zero too high or too low. Check or recalibrate sensor element.
CFSPN	Calibration FAIL (calculated gain exceeds limits)	Sensor output too high or too low during system cal. Recalibrate sensor element.
CWOFF	Calibration WARN (excessive sensor offset)	Sensor resting zero above nominal value. Check or recalibrate sensor element.
CWOVR	Calibration WARN (overrange during cycle)	Input > full scale during calibration cycle. Check range and calibration gas.
CWMT0	Calibration WARN (measurement timeout)	Measurement time exceeded limit. Check or replace sensor element.
CWRTO	Calibration WARN (recovery timeout)	Recovery time exceeded limit. Check or replace sensor element.
CWZTO	Calibration WARN (zero timeout)	Zero measurement time exceeded limit. Check or replace sensor element.
COMER	Controller failed to communicate with gas sensor.	Check wiring & Gas Sensor Comm Settings.
FBOOT	Unit performed factory cold boot.	Contact Welker.

Table C1: System Events (Continued)

Event	Description	Recommended Action
GMCAL	Gas sensor calibration cycle detected	User action
LOGCL	Event log cleared by user from main menu	User action
PWRLO	DC input power below DC 18 V	Check DC power for 24 V +/- 5%
PWRHI	DC input power above DC 30 V	Check DC power for 24 V +/- 5%
SBUMP	Sensor bump cycle recorded	Normal during rest if bump enabled
SEQAW	Measurement cycle abort via wireless interface	User action
SEQAM	Measurement cycle abort via MODBUS	User action
SEAU	Measurement cycle abort via user from main menu	User action
SEQSM	Measurement cycle started via MODBUS	User action
SEQSU	Measurement cycle started by user from menu.	User action
SEQSW	Measurement cycle started via wireless interface	User action
SFAIR	Measurement cycle fault* (purge air flow)	No purge air during measurement cycle. Check air pump and flame arrestors.
SFFSW	Measurement cycle fault* (flow switch)	Flow switch stuck in open position. Check in diagnostics mode. Replace if necessary.
SFGAS	Measurement cycle fault* (sample gas flow)	Check inlet valve and sample regulator setting for proper flow.
SFSEN	Measurement cycle fault* (sensor)	Sensor fault during measurement cycle. Check or recalibrate sensor element.
SWOFF	Measurement cycle warn (high sensor zero)	Sensor resting zero above nominal value. Check or recalibrate sensor element.
SWOVR	Measurement cycle warn (overrange during cycle)	Input exceeded full scale during measurement cycle. Check range.
SWMTO	Measurement cycle warn (measurement timeout)	Measurement time exceeded limit. Check or replace sensor element.
SWRTO	Measurement cycle warn (recovery timeout)	Recovery time exceeded limit. Check or replace sensor element.
SWZTO	Measurement cycle warn (zero timeout)	Zero measurement time exceeded limit. Check or replace sensor element.
SENER	Sensor element failed to stabilize during warm-up time	Check or replace sensor element.
STUOK	Startup OK	Signifies unit passed all start-up tests.
WCERR	Wireless chip initialization error	Contact Welker.
WCINI	Wireless chip initialization (during cold boot)	Normal



Only Measurement FAULT* errors will result in a FAULT output from the IntelliScent™. Warning conditions will be recorded in the Event Log and in the Sample Error Flags value.

APPENDIX D: INTELLISCENT™ APPLICATION FOR iPhone



The IntelliScent™ includes a wireless interface that supports remote access via the IntelliScent™ iOS app. The IntelliScent™ iOS app allows users to view and graph measurement data, change settings (if write-enabled), and send a snapshot of configuration and measurement data via email.



The IntelliScent™ iOS app is available free of charge from the Apple App Store.

1. Once the IntelliScent™ iOS app is installed, click the app icon to open the IntelliScent™ iOS app.
2. Press "Scan" to identify any local IntelliScent™ units, and then select the appropriate unit from the list.
3. Once connected, the app will display the current reading and unit status, history graph and tabular data, detailed information on the last sample and last calibration, and a set of tools and troubleshooting information that can be helpful in the field. See the Communications menu for more wireless settings options (Figure 23).

Figure D1: IntelliScent™ iOS App

